

CORPURI DE ILUMINAT "ST" CU E27

1

COD DABLEROM	COD PRODUCATOR	DENUMIRE	PAC.	PRET €
corp metalic (WL-8068) cu sticla si cu 2 dulii E27 pentru becuri economice max2x20W D:230mm h:90mm Ø:210mm				
00-001/alb	3-73270	alb (WH)	10	
00-001/gri	3-732769	gri (GR)	10	
00-001/argintiu	3-732768	argintiu (SG)	10	
00-001/crom	3-73276	crom (CH)	10	
00-001/satinat	3-732766	satinat (SN)	10	
00-001/auriu antic	3-732771	auriu antic (AB)	10	



corp metalic (WL-400C) fara sticla cu o dulie E27 pentru bec economice max20W D:140mm h:160mm Ø:120mm				
00-037	3-72700	alb (WH)	20	
00-038	3-727066	satinat (SN)	20	



corp din aluminiu (WL-2020) cu 2 dulii E27 pentru becuri economice max20W D:200x200mm h:100mm Ø:165x165mm				
00-0120	3-770270	alb (WH)	12	
00-0126	3-7702766	satinat (SN)	12	



corp din aluminiu (WL-2377) cu sticla mata si cu 2 dulii E27 pentru becuri economice max20W D:230x230mm h:110mm Ø:210x210mm				
00-1180	3-772270	alb (WH)	10	



CORPURI DE ILUMINAT "PT" CU E27

COD DABLEROM	COD PRODUCATOR	DENUMIRE	PAC.	PRET €
corp rotund (WL-8116) cu sticla si cu 2 dulii E27 pentru becuri economice max2x20W D:270mm h:60mm				
00-0720	3-72270	alb (WH)	8/1	
00-0726	3-722766	satinat (SN)	8/1	



corp patrat (WL-8226) cu sticla mata si cu 2 dulii E27 pentru becuri economice max2x20W D:260x260mm h:85mm				
00-0840	3-702270	alb (WH)	8/1	
00-0846	3-7022766	satinat (SN)	8/1	



CULORI DISPONIBILE:

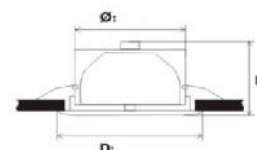
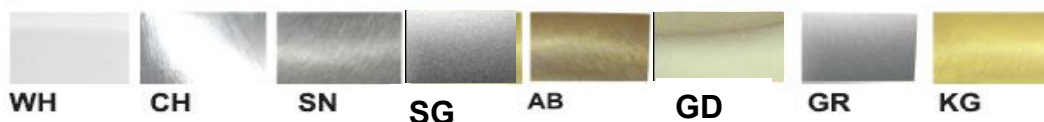

februarie 2012

CORPURI DE ILUMINAT "ST" PLC

2



COD DABLEROM	COD PRODUCATOR	DENUMIRE	PAC.	PRET €
corp metalic (WL-8068) cu sau fara sticla PLC 2x18W/2x26W/2x32W/2x42W				
D:230mm h:90mm Ø:210mm				
00-029	3-7326004	alb (WH)	10	
00-030	3-7326684	argintiu (SG)	10	
00-028	3-7326664	crom (CH)	10	
00-031	3-73266604	satinat (SN)	10	
00-027	3-7326714	auriu antic (AB)	10	

corp metalic (WL-8064) cu sticla PLC 2x18W/2x26W				
D:210mm h:115mm Ø:195mm				
00-052	3-70260	alb (WH)	12	
00-053	3-702669	gri (GR)	12	
00-054	3-70265	bronz (GD)	12	
00-056	3-702666	satinat (SN)	12	
00-057	3-702671	auriu antic (AB)	12	
00-057A	3-702600	lemn (WOOD)	12	



corp aluminiu (WL-6095) cu sticla PLC 2x13W				
D:160mm h:80mm Ø:150mm				
00-046	3-751304	alb (WH)	20	
00-047	3-751384	argintiu (SG)	20	
00-049	3-751364	crom (CH)	20	
00-050	3-7513664	satinat (SN)	20	
00-051	3-7513714	auriu antic (AB)	20	



corp aluminiu (WL-8095) cu sticla PLC 2x18W/2x26W/2x32W/2x42W				
D:230mm h:110mm Ø:210mm				
00-040	3-752604	alb (WH)	10	
00-041	3-752684	argintiu (SG)	10	
00-043	3-752664	crom (CH)	10	
00-044	3-7526664	satinat (SN)	10	
00-045	3-7526714	auriu antic (AB)	10	



CULORI DISPONIBILE:



WH

SG

CH

SN

AB

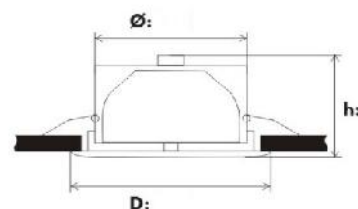

februarie 2012

CORPURI DE ILUMINAT "ST" PLC

3

COD DABLEROM	COD PRODUCATOR	DENUMIRE	PAC.	PRET €
corp aluminiu (WL-1313) cu sticla PLC 1x13W D:130x130mm h:100mm Ø:112x112mm				
00-011/alb	3-71130	alb (WH)	20	
00-011/gri	3-711369	gri (GR)	20	



corp aluminiu (WL-1616) cu sticla PLC 2x13W/2x18W D:160x160mm h:100mm Ø:140x140mm				
00-015	3-71304	alb (WH)	12	
00-016	3-713694	gri (GR)	12	



corp aluminiu (WL-2020) cu sticla PLC 2x18W/2x26W/2x32W/2x42W D:200x200mm h:100mm Ø:165x165mm				
00-012	3-7702604	alb (WH)	12	
00-013	3-7702684	argintiu (SG)	12	
00-014	3-77026664	satinat (SN)	12	



corp aluminiu (WL-2323) cu sticla PLC 2x18W/2x26W/2x32W/2x42W D:230x230mm h:120mm Ø:210x210mm				
00-000	3-77260	alb (WH)	10	
00-002	3-77265	bronz (GD)	10	
00-004	3-7726664	satinat (SN)	10	
00-005	3-772671	auriu antic (AB)	10	



corp aluminiu (WL-2377) cu sticla PLC 2x18W/2x26W/2x32W D:230x230mm h:110mm Ø:210x210mm				
00-118	3-7722604	alb (WH)	10	



corp aluminiu (WL-836) cu sticla PLC 2x13W mobil 45° D:230x144mm h:120mm Ø:215x130mm				
00-033	3-70130	alb (WH)	20	
00-034	3-70135	bronz (GD)	20	
00-036	3-701371	auriu antic (AB)	20	



CULORI DISPONIBILE:

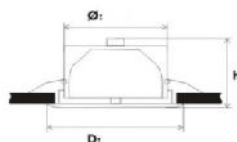

februarie 2012

CORPURI DE ILUMINAT "ST" HQI

4

COD DABLEROM	COD PRODUCATOR	DENUMIRE	PAC.	PRET €
corp metalic (WL-8068) cu sticla HQI 150W D:230mm h:90mm Ø:210mm				
00-032/alb	3-281500	alb (WH)	10	
00-032/satinat	3-2815066	satinat (SN)	10	



corp metalic (WL-8064) cu sticla HQI 150W D:210mm h:115mm Ø:195mm				
00-059	3-261569	gri (GR)	12	
00-061	3-26156	crom (CH)	12	
00-063	3-261571	auriu antic (AB)	12	



corp aluminiu (WL-6095) cu sticla HQI 70W D:160mm h:80mm Ø:150mm				
00-138	3-21700	alb (WH)	20	
00-141	3-21706	crom (CH)	20	
00-142	3-217066	satinat (SN)	20	



corp aluminiu (WL-8095) cu sticla HQI 150W D:230mm h:110mm Ø:210mm				
00-132	3-211500	alb (WH)	10	
00-133	3-2115069	gri (GR)	10	
00-136	3-2115066	satinat (SN)	10	



corp aluminiu (WL-8459) cu sticla HQI 150W reglabil 60° D:242mm h:180mm Ø:220mm				
00-130	3-241500	alb (WH)	8	



corp aluminiu (DLT-184) cu sticla HQI 70W G12 reglabil 80° D:170mm h:220mm Ø:150mm				
00-148	3-007040	alb (WH)	12	
00-149	3-007046	gri (GR)	12	



CULORI DISPONIBILE:

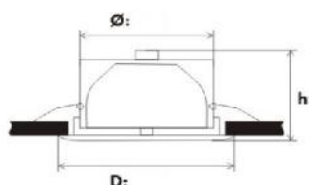
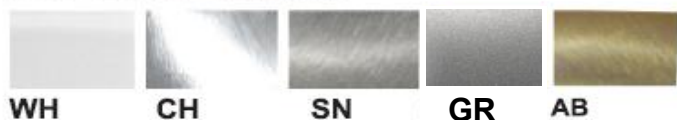

CORPURI DE ILUMINAT "ST" HQI

5

COD DABLEROM	COD PRODUCATOR	DENUMIRE	PAC.	PRET €
corp aluminiu (WL-2020) cu sticla HQI 150w D:200x200mm h:100mm Ø:165x165mm				
00-112	3-21500	alb (WH)	12	
00-113	3-215068	argintiu (SG)	12	
00-114	3-215066	satinat (SN)	12	



corp aluminiu (WL-2377) cu sticla HQI 150W D:230x230mm h:110mm Ø:210x210mm				
00-119	3-221500	alb (WH)	10	



corp aluminiu (WL-836) cu sticla HQI 70W reglabil 45° D:230x144mm h:120mm Ø:215x130mm				
00-126	3-237068	argintiu (SG)	10	
00-128	3-237066	satinat (SN)	10	



corp aluminiu (WL-836) cu sticla HQI 150W reglabil 45° D:230x144mm h:120mm Ø:215x130mm				
00-120	3-23150	alb (WH)	10	
00-121	3-231569	gri (GR)	10	
00-122	3-23155	bronz (GD)	10	
00-123	3-231566	satinat (SN)	10	
00-124	3-231571	auriu antic (AB)	10	



CORPURI DE ILUMINAT "PT" PLC

COD DABLEROM	COD PRODUCATOR	DENUMIRE	PAC.	PRET €
corp rotund (WL-6116) cu sticla PLC 2x13W cu sistem de pornire inclus D:227mm h:60mm				
00-082	3-721366	satinat (SN)	8/1	



corp rotund (WL-8116) cu sticla PLC 2x26W cu sistem de pornire inclus D:270mm h:60mm				
00-072	3-72260	alb (WH)	8/1	
00-073	3-7226698	argintiu (SG)	8/1	
00-075	3-72266	crom (CH)	8/1	
00-076	3-722666	satinat (SN)	8/1	



corp patrat (WL-8226) cu sticla PLC 2x26W cu sistem de pornire inclus D:260x260mm h:85mm				
00-085	3-702268	argintiu (SG)	5/1	
00-086	3-70226	crom (CH)	5/1	
00-087	3-702266	satinat (SN)	5/1	



CULORI DISPONIBILE:

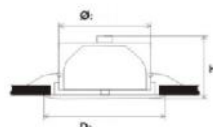

februarie 2012

COD DABLEROM	COD PRODUCATOR	DENUMIRE	PAC.	PRET €
proiector (CL-388) HQI 70w G12 simetric IP20				
00-536/alb	3-007030	alb (WH)	8	
00-536/gri	3-0070369	gri (GR)	8	



COD DABLEROM	COD PRODUCATOR	DENUMIRE	PAC.	PRET €
proiector (CL-211) HQI 70w Rx7S simetric IP20				
00-537/alb	3-007010	alb (WH)	12	
00-537/gri	3-0070169	gri (GR)	12	



COD DABLEROM	COD PRODUCATOR	DENUMIRE	PAC.	PRET €
proiector HQI 150w Rx7S simetric IP20				
00-538/alb	3-0150000	alb (WH)	4	
00-538/gri	3-0150006	gri (GR)	4	



CULORI DISPONIBILE:



CORPURI DE ILUMINAT AR111

COD DABLEROM	COD PRODUCATOR	DENUMIRE	PAC.	PRET €
spot gri (WL-F) incastrat reglabil pentru bec AR111				
00-171	3-12126	1x50W (WL-F11) L:195mm W:195mm h:140mm Ø160x160mm	8/1	
00-172	3-12226	2x50W (WL-F12) L:345mm W:195mm h:140mm Ø310x160mm	8/1	
00-173	3-12326	3x50W (WL-F13) L:495mm W:195mm h:140mm Ø470x160mm	4/1	
00-174	3-12426	4x50W (WL-F14) L:645mm W:195mm h:140mm Ø610x160mm	4/1	



spot gri (XF-B) incastrat reglabil cu becuri AR111 50W 12V				
00-160	3-121006	1x50W (XF 001B) L:205mm W:205mm h:105mm Ø190x190mm	12/1	
00-161	3-122006	2x50W (XF 002B) L:355mm W:205mm h:105mm Ø345x190mm	8/1	
00-162	3-123006	3x50W (XF 003B) L:505mm W:205mm h:105mm Ø495x190mm	6/1	



spot aluminiu (WL-6701) incastrat reglabil pentru bec AR111				
00-170/1	3-6701166	1x50W (WL-67011) L:180mm W:180mm h:25mm Ø150x150mm	20/1	
00-170/2	3-6701266	2x50W (WL-67012) L:340mm W:180mm h:25mm Ø310x150mm	10/1	
00-170/3	3-6701366	3x50W (WL-67013) L:495mm W:195mm h:25mm Ø465x150mm	10/1	



spot gri (XF-004) reglabil aparent cu transformator & becuri AR111 50W 12V				
00-164	3-104006	4x50W (XF004GR)	4/1	



spot gri (XF-004) reglabil aparent cu transformator & becuri AR111 50W 12V				
00-165	3-114006	4x50W (XF004DR)	4/1	



spot gri (XF-004) reglabil aparent cu transformator & becuri AR111 50W 12V				
00-166	3-114106	4x50W (XF004DS)	4/1	



COD DABLEROM	COD PRODUCATOR	DENUMIRE	PAC.	PRET €
spot aluminiu (DL9W) incastat reglabil 20° 3x3W=9W D:130mm h:36mm Ø:110mm				
00-490/cald	21-7033306600	satinat (SN) lumina alba calda 30°	20	
00-491/cald	21-7033606600	satinat (SN) lumina alba calda 60°	20	
00-490/rece	21-703330660	satinat (SN) lumina alba rece 30°	20	
00-491/rece	21-703360660	satinat (SN) lumina alba rece 60°	20	



COD DABLEROM	COD PRODUCATOR	DENUMIRE	PAC.	PRET €
spot aluminiu (DL18WT) incastat reglabil 80° 6x3W=18W D:180mm h:110mm Ø:155mm				
00-486/cald	21-76330600	argintiu (SG) lumina alba calda 30°	12	
00-488/cald	21-763306600	satinat (SN) lumina alba calda 30°	12	
00-489/cald	21-763606600	satinat (SN) lumina alba calda 60°	12	
00-486/rece	21-7633060	argintiu (SG) lumina alba rece 30°	12	
00-488/rece	21-76330660	satinat (SN) lumina alba rece 30°	12	
00-489/rece	21-76360660	satinat (SN) lumina alba rece 60°	12	



COD DABLEROM	COD PRODUCATOR	DENUMIRE	PAC.	PRET €
spot cu sticla (DA3Wx3) incastat 3x3W=9W D:87mm h:63mm Ø:73mm				
00-492/cald	21-713330000	opal (OP) lumina alba calda 30°	20	
00-493/cald	21-713390000	opal (OP) lumina alba calda 90°	20	
00-492/rece	21-71333000	opal (OP) lumina alba rece 30°	20	
00-493/rece	21-71339000	opal (OP) lumina alba rece 90°	20	



COD DABLEROM	COD PRODUCATOR	DENUMIRE	PAC.	PRET €
spot cu sticla (DA18W) incastat 6x3W=18W D:170mm h:115mm Ø:150mm				
00-494/cald	21-716330000	opal (OP) lumina alba calda 30°	12	
00-495/cald	21-716390000	opal (OP) lumina alba calda 90°	12	
00-494/rece	21-71633000	opal (OP) lumina alba rece 30°	12	
00-495/rece	21-71639000	opal (OP) lumina alba rece 90°	12	



COD DABLEROM	COD PRODUCATOR	DENUMIRE	PAC.	PRET €
spot cu sticla (DC18W) aparent 6x3W=18W D:170mm h:80mm				
00-496/cald	21-7163306600	opal & satinat lumina alba calda 30°	12	
00-497/cald	21-7163906600	opal & satinat lumina alba calda 90°	12	
00-496/rece	21-716330660	opal & satinat lumina alba rece 30°	12	
00-497/rece	21-716390660	opal & satinat lumina alba rece 90°	12	



SPOTURI PENTRU BEC MR16/GU10 Ø50mm

9

COD DABLEROM	COD PRODUCATOR	DENUMIRE	PAC.	PRET €
spot aluminiu (WL-121) incastat D:80mm Ø:62mm				
00-220	21-1210	alb (WH)	20	
00-227	21-12169	gri (GR)	20	
00-222	21-1216	crom (CH)	20	
00-223	12-12166	satinat (SN)	20	
00-224	21-1217	auriu mat (GM)	20	
00-225	21-12171	auriu antic (AB)	20	
00-226	21-12177	cupru (AC)	20	
00-221	21-17605	auriu lucios (BP)	20	
00-228	21-1219	auriu (KG)	20	
00-229	21-73069	gri perla (GR-P)	20	
00-230	21-12199	auriu perla (KG-P)	20	



spot aluminiu (WL-101) incastat reglabil D:84mm Ø:75mm				
00-268	21-1010	alb (WH)	20	
00-275	21-10169	gri (GR)	20	
00-270	21-1016	crom (CH)	20	
00-271	21-10166	satinat (SN)	20	
00-272	21-1017	auriu mat (GM)	20	
00-273	21-10171	auriu antic (AB)	20	
00-274	21-10177	cupru (AC)	20	
00-276	21-1019	auriu (KG)	20	



spot aluminiu incastat reglabil				
00-169/1	3-4701166	simplicu D:92mm h:25mm Ø:82mm	50/1	
00-169/2	3-4701266	dublu D:174x92mm h:25mm Ø:162x82mm	20/1	
00-169/3	3-4701366	triplu D:256x92mm h:25mm Ø:244x82mm	20/1	



spot aluminiu bicolor (1759) incastat D:85mm Ø:70mm				
00-266	21-1759699	gri perla/auriu (KG.P-AB)	10	
00-267	21-1759999	auriu perla/auriu (PG-KG)	10	



spot aluminiu bicolor (1757) incastat reglabil D:85mm Ø:76mm				
00-285	21-175769	auriu/gri perla/auriu (BP-GR.P-BP)	10	



CULORI DISPONIBILE:



SPOTURI PENTRU BEC MR16/GU10 Ø50mm

10



COD DABLEROM	COD PRODUCATOR	DENUMIRE	PAC.	PRET €
spot metalic cu inel din sticla (730A-W) incastat D:80mm Ø:60mm				
00-235	21-730000	alb (WH) + sticla alba (WH)	10	
00-236	21-730050	auriu lucios (BP) + sticla alba (WH)	10	
00-237	21-730064	crom (CH) + sticla albastra (BE)	10	
00-238	21-7300664	satinat (SN) + sticla albastra (BE)	10	
00-239	21-730070	auriu antic (PB) + sticla alba (WH)	10	
00-240	21-7300770	cupru (AN-COP) + sticla alba (WH)	10	

spot patrat cu sticla (WL-174) incastat D:85mm Ø:61mm				
00-440	21-174166	satinat (SN)	50/1	



spot patrat cu sticla (WL-175) incastat D:85mm Ø:61mm				
00-441	21-175266	satinat (SN)	50/1	



spot cu sticla (1567) incastat D:80mm Ø:70mm				
00-200	21-15670	alb (WH)	50/1	
00-201	21-15672	roz (WH/PK)	50/1	
00-202	21-15673	verde (WH/GN)	50/1	
00-203	21-15674	albastru (WH/BE)	50/1	



CULORI DISPONIBILE:



CULORI DISPONIBILE:



SPOTURI PENTRU BEC MR16/GU10 Ø50mm

11



COD DABLEROM	COD PRODUCATOR	DENUMIRE	PAC.	PRET €
spot aluminiu triunghiular (3719) incastat D:90mm Ø:69mm				
00-295	21-37190	alb (WH)	10	
00-296	21-371969	gri (GR)	10	
00-297	21-37195	auriu lucios (BP)	10	
00-298	21-37196	crom (CH)	10	
00-299	21-371966	satinat (SN)	10	
00-300	21-37197	auriu antic (PB)	10	
00-301	21-371971	auriu rustic (AN-BRASS)	10	
00-302	21-371977	cupru (AN-COP)	10	

spot aluminiu patrat (WL-158) incastat reglabil D:80mm Ø:72mm				
00-287	21-1580	alb (WH)	20	
00-293	21-15869	gri (GR)	20	
00-288	21-1586	crom (CH)	20	
00-289	21-15866	satinat (SN)	20	
00-290	21-1587	auriu mat (GM)	20	
00-291	21-15871	auriu antic (AB)	20	
00-292	21-15877	cupru (AC)	20	



spot aluminiu (WL-618) incastat reglabil 45° D:101mm Ø:86mm				
00-450	21-6180	alb (WH)	50/1	
00-451	21-61869	gri (GR)	50/1	
00-452	21-6186	crom (CH)	50/1	
00-453	21-61866	satinat (SN)	50/1	
00-454	21-61871	auriu antic (AB)	50/1	
00-455	21-61899	auriu mat (GM)	50/1	



spot aluminiu patrat (WL-628) incastat reglabil 45° D:98x98mm Ø:87mm				
00-460	21-6280	alb (WH)	50/1	
00-461	21-62869	gri (GR)	50/1	
00-462	21-6286	crom (CH)	50/1	
00-463	21-62866	satinat (SN)	50/1	
00-464	21-62871	auriu antic (AB)	50/1	



CULORI DISPONIBILE:



februarie 2012



COD DABLEROM	COD PRODUCATOR	DENUMIRE	PAC.	PRET €
spot aluminiu (WL-144) incastat D:61mm Ø:45mm				
00-323	21-1440	alb (WH)	20	
00-329	21-14469	gri (GR)	20	
00-324	21-1446	crom (CH)	20	
00-325	21-14466	satinat (SN)	20	
00-326	21-1447	auriu mat (GM)	20	
00-327	21-14471	auriu antic (AB)	20	
00-328	21-14477	cupru (AC)	20	

spot aluminiu (WL-112) incastat reglabil D:65mm Ø:57mm				
00-335	21-1120	alb (WH)	20	
00-343	21-11269	gri (GR)	20	
00-337	21-1126	crom (CH)	20	
00-338	21-11266	satinat (SN)	20	
00-339	21-1127	auriu mat (GM)	20	
00-340	21-11271	auriu antic (AB)	20	
00-341	21-11277	cupru (AC)	20	
00-342	21-1129	auriu (KG)	20	
00-344	21-73299	auriu perla (KG-P)	10	



spot metalic (702) incastat reglabil D:80mm Ø:60mm				
00-313	21-7020	alb (WH)	10	
00-314	21-7025	auriu lucios (BP)	10	
00-315	21-7026	crom (CH)	10	



spot aluminiu bicolor (1758) incastat reglabil D:65mm Ø:57mm				
00-348	21-175899	crom/auriu perla/crom (CP-KG.P-CP)	10	



spot aluminiu patrat (WL-758) incastat reglabil D:61mm Ø:56mm				
00-349	21-7580	alb (WH)	20	
00-350	21-7586	crom (CH)	20	
00-351	21-75866	satinat (SN)	20	
00-352	21-7587	auriu mat (GM)	20	
00-353	21-75871	auriu antic (AB)	20	



CULORI DISPONIBILE:



SPOTURI PENTRU BEC BULB



13

COD DABLEROM	COD PRODUCATOR	DENUMIRE	PAC.	PRET €
spot metalic patrat (WL-276) incastat pentru bec G4 12V & 240V D:73x73mm h:18mm Ø:65mm				
00-400	21-2760	alb (WH)	10	
00-401	21-2766	crom (CH)	10	
00-402	21-27666	satinat (SN)	10	
00-403	21-27671	auriu antic (AB)	10	
00-404	21-2769	auriu (GD)	10	

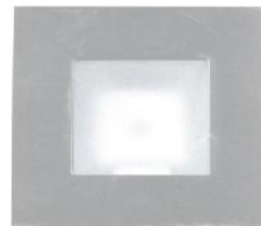

spot metalic patrat (WL-277) incastat pentru bec G4 12V & 240V D:73x73mm h:18mm Ø:65mm				
00-405	21-2770	alb (WH)	10	
00-406	21-2776	crom (CH)	10	
00-407	21-27766	satinat (SN)	10	
00-409	21-2779	auriu (GD)	10	



spot aluminiu patrat (WL-2211) incastat pentru bec G5.35 D:90x90mm h:60mm Ø:80mm				
00-410	21-22110	alb (WH)	50/1	
00-411	21-221169	gri (GR)	50/1	
00-412	21-22116	crom (CH)	50/1	
00-414	21-221171	auriu antic (AB)	50/1	
00-415	21-22119	auriu (KG)	50/1	
00-416	21-221199	auriu mat (GM)	50/1	



spot metalic (WL-254) incastat reglabil pentru bec G4 12V & 240V D:80x60mm h:27mm Ø:65x50mm				
00-420	21-2546	crom (CH)	10	
00-421	21-25466	satinat (SN)	10	
00-422	21-25471	auriu antic (AB)	10	



CULORI DISPONIBILE:



februarie 2012

SPOTURI PENTRU BEC BULB

14



COD DABLEROM	COD PRODUCATOR	DENUMIRE	PAC.	PRET €
spot aluminiu (WL-135) incastat pentru bec G4 , G5.3 12V & 240V D:34mm Ø:26mm				
00-354	21-1350	alb (WH)	20	
00-356/gri	21-13569	gri (GR)	20	
00-355	21-1356	crom (CH)	20	
00-356/satinat	21-13566	satinat (SN)	20	
00-357/mat	21-1357	auriu mat (GM)	20	
00-357/antic	21-13571	auriu antic (AB)	20	
00-358	21-13577	cupru (AC)	20	
00-357/auriu	21-1359	auriu (KG)	20	

spot metalic cu oglinda (1751) incastat pentru bec G4 12V & 240V D:50mm Ø:43mm				
00-361	21-17516	crom (CH)	10	
00-362	21-175166	satinat (SN)	10	
00-368	21-175199	auriu perla (KG-P)	10	



spot patrat din cristal (WL-803) incastat pentru bec JC4 12V & 240V D:70mm Ø:53mm				
00-430	21-80316	crom (CH)	50/1	



spot rotund din cristal (WL-815) incastat pentru bec JC4 12V & 240V D:70mm Ø:53mm				
00-431	21-81516	crom (CH)	50/1	



SPOTURI IP 65

COD DABLEROM	COD PRODUCATOR	DENUMIRE	PAC.	PRET €
spot aluminiu IP65 (WL-506) incastat pentru bec JC5.3 12V & 240V D:100mm h:92mm Ø:76mm				
00-303	21-5060	crom (CH)	50/1	
00-304	21-50666	satinat (SN)	50/1	



spot aluminiu IP65 incastat pentru bec MR16 Ø50mm 12V D:85mm h:30mm Ø:75mm				
00-345	21-79466	satinat (SN) rotund (WL-794)	10	
00-346	21-79666	satinat (SN) patrat (WL-796)	10	



CULORI DISPONIBILE:



WH CH GR SN GM AB KG AC

februarie 2012



COD DABLEROM	COD PRODUCATOR	DENUMIRE	PAC.	PRET €
spot metalic (117) incastrat pentru bec G4 12V & 240V D:70mm h:22mm Ø:60mm				
00-381	21-01171	negru (BK)	10	
00-382	21-01176	crom (CH)	10	
00-383	21-011766	satinat (SN)	10	
00-385	21-011771	auriu antic (AB)	10	
00-386	21-01179	auriu (KG)	10	

spot metalic (20028) incastrat cu 28 leduri - 2W - 240V D:67mm h:20mm Ø:50mm				
00-378/satinat	21-20028666	satinat (SN) lumina alba calda	10	
00-379/satinat	21-2002866	satinat (SN) lumina alba rece	10	
00-378/antic	21-20028700	auriu antic (AB) lumina alba calda	10	
00-379/antic	21-2002870	auriu antic (AB) lumina alba rece	10	



spot metalic (119) aparent pentru bec G4 12V & 240V D:70mm h:24mm				
00-390	21-11968	crom (CH)	10	
00-391	21-119668	satinat (SN)	10	
00-393	21-119718	auriu antic (AB)	10	



spot metalic (119) aparent cu 28 leduri - 2W - 240V D:70mm h:24mm				
00-363/satinat	21-11966900	satinat (SN) lumina alba calda	10	
00-364/satinat	21-1196690	satinat (SN) lumina alba rece	10	
00-363/antic	21-1197900	auriu antic (AB) lumina alba calda	10	
00-364/antic	21-119790	auriu antic (AB) lumina alba rece	10	



CULORI DISPONIBILE:



CH



SN



AB



KG

COD DABLEROM	COD PRODUCATOR	DENUMIRE	PAC.	PRET €
spot plastic (3753) aparent pentru bec GX53 240V D:99mm h:14mm				
00-204	21-37536	argintiu (SILVER)	1	
00-205	21-37537	maro (BROWN)	1	



spot plastic (3753) aparent cu intrerupator pentru bec GX53 240V D:90mm h:32mm				
00-215	21-375307	maro (BROWN)	1	



spot inox (3053) incastat pentru bec GX53 240V D:93mm h:27mm Ø:85mm				
00-218	21-305366	satinat (INOX)	1	



spot inox (30531) aparent pentru bec GX53 240V D:95mm h:34mm				
00-216	21-3053166	satinat (INOX)	1	



spot inox triunghiular (30530) aparent cu intrerupator pentru bec GX53 240V L:163mm W:167mm h:50mm				
00-219	21-3053066	satinat (INOX)	1	



spot inox triunghiular (3059) aparent cu intrerupator pentru bec G4 12V & 240V L:153mm W:130mm h:47mm				
00-217	21-305966	satinat (INOX)	1	

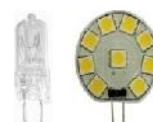

COD DABLEROM	COD PRODUCATOR	DENUMIRE	PAC.	PRET €
spot aluminiu mini (95016) incastrat cu 6 leduri 0.4W (necesita rama) L:53mm D:30mm Ø:31mm				
00-366/cald	3-9501600	lumina alba cald	40/1	
00-366/rece	3-950160	lumina alba rece	40/1	
00-366/albastru	3-950164	lumina albastru	40/1	



spot aluminiu mini (9501) incastrat cu 1 power led 1W (necesita rama) L:90mm D:30mm Ø:31mm				
00-367/cald	3-950100	lumina alba cald	40/1	
00-367/rece	3-95010	lumina alba rece	40/1	
00-367/albastru	3-95014	lumina albastru	40/1	



rama rotunda pentru spoturi 00-366 sau 00-367				
D:40mm				
00-376/gri	3-95016	gri	40/1	
00-376/inox	3-9501666	INOX 316	40/1	
00-376/satinat	3-950166	satinat	40/1	
00-376/antic	3-950170	auriu antic	40/1	
00-376/rustic	3-950171	auriu rustic	40/1	
00-376/ruginiu	3-9501781	ruginiu	40/1	



rama patrata pentru spoturi 00-366 sau 00-367				
D:40x40mm				
00-377/gri	3-950126	gri	40/1	
00-377/inox	3-95012666	INOX 316	40/1	
00-377/satinat	3-9501266	satinat	40/1	
00-377/antic	3-950127	auriu antic	40/1	
00-377/rustic	3-9501271	auriu rustic	40/1	
00-37/ruginiu	3-95012781	ruginiu	40/1	

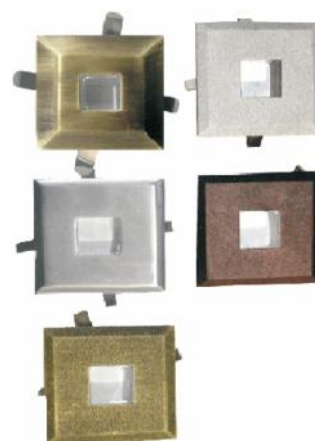

CULORI DISPONIBILE:

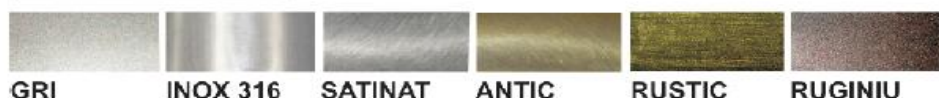

GRI INOX 316 SATINAT ANTIC RUSTIC RUGINIU

COD DABLEROM	COD PRODUCATOR	DENUMIRE	PAC.	PRET €
spot aluminiu extra mini (9544) incastat cu 1 led 0.2W 15° 12V L:35mm D:16mm Ø:12mm				
00-307/cald	3-954400	satinat (SN) lumina alba calda	20/1	
00-307/rece	3-95440	satinat (SN) lumina alba rece	20/1	
00-307/albastru	3-95444	satinat (SN) lumina albastra	20/1	
00-307/portocaliu	3-95443	satinat (SN) lumina portocalie	20/1	



spot aluminiu extra mini (9544) incastat cu 1 led 0.2W 15° 12V L:35mm D:16mm Ø:12mm				
00-308/cald	3-9544700	auriu antic (AB) lumina alba calda	20/1	
00-308/albastru	3-954474	auriu antic (AB) lumina albastra	20/1	
00-308/portocaliu	3-954473	auriu antic (AB) lumina portocalie	20/1	

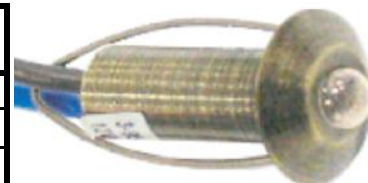

CULORI DISPONIBILE:

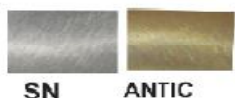

COD DABLEROM	COD PRODUCATOR	DENUMIRE	PAC.	PRET €
spot aluminiu super mini (9542) incastat cu 1 led 0.6W 40° 12V L:32mm D:25mm Ø:20mm				
00-305/cald	3-954200	satinat (SN) lumina alba calda	20/1	
00-305/rece	3-95420	satinat (SN) lumina alba rece	20/1	
00-305/albastru	3-95424	satinat (SN) lumina albastra	20/1	



spot aluminiu super mini (9541) incastat cu 1 led 0.6W 40° 230V L:47mm D:27mm Ø:18.5mm				
00-306/cald	3-954100	satinat (SN) lumina alba calda	20/1	
00-306/rece	3-95410	satinat (SN) lumina alba rece	20/1	
00-306/albastru	3-95414	satinat (SN) lumina albastra	20/1	



COD DABLEROM	COD PRODUCATOR	DENUMIRE	PAC.	PRET €
corp aluminiu patrat (9621) incastat cu 9 leduri 0.6W (necesita rama) L:71mm W:71mm h:51mm Ø:65x65mm				
00-9621/cald	3-962100	lumina alba cald a	40/1	
00-9621/rece	3-96210	lumina alba rece	40/1	
00-9621/albastru	3-96214	lumina albastru	40/1	



rama patrata pentru spoturi 00-9621				
00-967	3-96211	INOX fara grilaj	40/1	
00-966	3-96212	INOX cu grilaj	40/1	



COD DABLEROM	COD PRODUCATOR	DENUMIRE	PAC.	PRET €
corp aluminiu dreptunghiular (9601) incastat cu 12 leduri 0.8W (necesita rama) L:111mm W:44mm h:51mm Ø:100x36mm				
00-9601/cald	3-960100	lumina alba cald a	40/1	
00-9601/rece	3-96010	lumina alba rece	40/1	
00-9601/albastru	3-96014	lumina albastru	40/1	



rama dreptunghiulara pentru spoturi 00-9601				
00-969	3-96011	INOX fara grilaj	40/1	
00-968	3-96012	INOX cu grilaj	40/1	



COD DABLEROM	COD PRODUCATOR	DENUMIRE	PAC.	PRET €
corp aluminiu dreptunghiular (5295) incastat cu 16 leduri 1W lumina indirecta L:162mm W:100mm h:72mm Ø:160x98mm				
00-948/cald	3-5295600	gri (GR) lumina alba cald a	18/1	
00-948/rece	3-529560	gri (GR) lumina alba rece	18/1	
00-948/albastru	3-529564	gri (GR) lumina albastru	18/1	

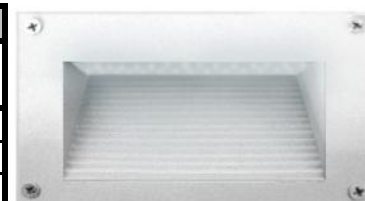

corp aluminiu dreptunghiular (5296) incastat cu 16 leduri 1W lumina indirecta L:100mm W:162mm h:72mm Ø:98x160mm				
00-949/cald	3-5296600	gri (GR) lumina alba cald a	18/1	
00-949/rece	3-529660	gri (GR) lumina alba rece	18/1	
00-949/albastru	3-529664	gri (GR) lumina albastru	18/1	



COD DABLEROM	COD PRODUCATOR	DENUMIRE	PAC.	PRET €
corp aluminiu dreptunghiular (1300) incastat cu 12 leduri 0.7W (necesita rama) L:145mm W:45mm h:51mm Ø:145x45mm				
00-9801/cald	3-980100	lumina alba cald	10/1	
00-9801/rece	3-98010	lumina alba rece	10/1	
00-9801/albastru	3-98014	lumina albastru	10/1	



rama dreptunghiulara pentru spoturi 00-9801				
00-970/alb	3-9801	alb	10/1	
00-970/gri	3-98016	gri	10/1	
00-970/satinat	3-980166	satinat	10/1	
00-970/antic	3-98017	auriu antic	10/1	
00-970/rustic	3-980171	auriu rustic	10/1	
00-970/ruginiu	3-980181	ruginiu	10/1	



COD DABLEROM	COD PRODUCATOR	DENUMIRE	PAC.	PRET €
corp aluminiu dreptunghiular (1310) incastat cu 12 leduri 0.7W (necesita rama) L:145mm W:45mm h:51mm Ø:145x45mm				
00-9811/cald	3-981100	lumina alba cald	10/1	
00-9811/rece	3-98110	lumina alba rece	10/1	
00-9811/albastru	3-98114	lumina albastru	10/1	



rama dreptunghiulara pentru spoturi 00-9811				
00-971/alb	3-98020	alb	10/1	
00-971/gri	3-980206	gri	10/1	
00-971/satinat	3-9802066	satinat	10/1	
00-971/antic	3-980207	auriu antic	10/1	
00-971/rustic	3-9802071	auriu rustic	10/1	
00-971/ruginiu	3-9802081	ruginiu	10/1	

**CULORI DISPONIBILE:**

ALB

GRI

SATINAT

ANTIC

RUSTIC

RUGINIU

februarie 2012

COD DABLEROM	COD PRODUCATOR	DENUMIRE	PAC.	PRET €
corp "stainless steel 316" rotund incastrat cu 18 leduri (orizontal) - 1W D:180mm h:90mm Ø:135mm				
00-979	3-130706	lumina alba rece	8/1	
00-980	3-130726	lumina rosie	8/1	
00-981	3-130746	lumina albastra	8/1	



corp "stainless steel 316" rotund incastrat cu 90 leduri (vertical) - 3W D:180mm h:100mm Ø:135mm				
00-974/90/cald	3-9108900	lumina alba calda	8/1	
00-974/90/rece	3-910890	lumina alba rece	8/1	
00-975/90	3-9108904	lumina albastra	8/1	



corp "stainless steel 316" patrat incastrat cu 16 leduri (orizontal) - 1W D:150x150mm h:121mm Ø:100x100mm				
00-976	3-1304060	lumina alba rece	16/1	
00-977	3-130426	lumina rosie	16/1	
00-978	3-130446	lumina albastra	16/1	

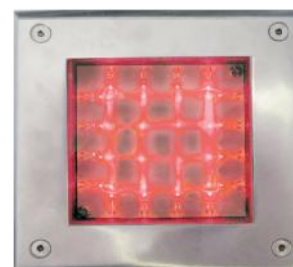

corp "stainless steel 316" patrat incastrat cu 33 leduri (vertical) - 1.5W D:150x150mm h:180mm Ø:110x110mm				
00-973/33	3-1372446	lumina albastra	6/1	



corp "stainless steel 316" patrat incastrat cu 60 leduri (vertical) - 2W D:150x150mm h:180mm Ø:110x110mm				
00-972/60/cald	3-9078600	lumina alba calda	12/1	
00-972/60/rece	3-907860	lumina alba rece	12/1	
00-973/60	3-9078604	lumina albastra	12/1	



COD DABLEROM	COD PRODUCATOR	DENUMIRE	PAC.	PRET €
corp "stainless steel 316" (8221) rotund incastrat pentru bec AR111 12V D:180mm h:160mm				
00-958	3-822166	satinat	8/1	



COD DABLEROM	COD PRODUCATOR	DENUMIRE	PAC.	PRET €
corp "stainless steel 316" (8212) rotund aparent cu 60 leduri D:190mm h:45mm				
00-956	3-8212660	lumina alba rece -48 LED -5W 12V AC/DC	12/1	
00-956/60	3-82126601	lumina alba rece 6.5W 12V AC/DC	12/1	
00-956/rgb/2	3-8212669	lumina R.G.B. cu 2 cabluri 4W 12V AC	12/1	
00-956/rgb/4	3-82126699	lumina R.G.B. cu 4 cabluri 4W 12V DC	8/1	



COD DABLEROM	COD PRODUCATOR	DENUMIRE	PAC.	PRET €
corp "stainless steel 316" (8211) rotund aparent cu 120 leduri D:270mm h:41mm				
00-957/120	3-82116601	lumina alba rece 12W 12V AC/DC	8/1	
00-957/rgb/2	3-8211669	lumina R.G.B. cu 2 cabluri 7W 12V AC	8/1	
00-957/rgb/4	3-82116699	lumina R.G.B. cu 4 cabluri 7W 12V DC	8/1	



COD DABLEROM	COD PRODUCATOR	DENUMIRE	PAC.	PRET €
corp "stainless steel 316" rotund aparent cu 9 power led si transformator 230V D:270mm h:45mm				
00-959	3-108290	lumina alba rece 9W 230V AC	8/1	



COD DABLEROM	COD PRODUCATOR	DENUMIRE		PAC.	PRET €
corp de iluminat rotund aluminiu (9732) aparent cu 5 leduri 0.3W					
D:71mm h:19mm					
00-018/gri	3-9732600	gri	lumina alba calda	40/1	
00-018/satinat	3-97326600	satinat	lumina alba calda	40/1	
00-018/antic	3-9732700	auriu antic	lumina alba calda	40/1	
00-018/rustic	3-97327100	auriu rustic	lumina alba calda	40/1	
00-018/ruginiu	3-97328100	ruginiu	lumina alba calda	40/1	
00-019/gri	3-973260	gri	lumina alba rece	40/1	
00-019/satinat	3-9732660	satinat	lumina alba rece	40/1	
00-019/antic	3-973270	auriu antic	lumina alba rece	40/1	
00-019/rustic	3-9732710	auriu rustic	lumina alba rece	40/1	
00-019/ruginiu	3-9732810	ruginiu	lumina alba rece	40/1	
00-020/gri	3-973264	gri	lumina albastra	40/1	
00-020/satinat	3-9732664	satinat	lumina albastra	40/1	



corp de iluminat patrat aluminiu (9734) aparent cu 9 leduri 0.6W					
L:71x71mm h:25mm					
00-021/gri	3-9734600	gri	lumina alba calda	40/1	
00-021/satinat	3-97346600	satinat	lumina alba calda	40/1	
00-021/antic	3-9734700	auriu antic	lumina alba calda	40/1	
00-021/rustic	3-97347100	auriu rustic	lumina alba calda	40/1	
00-021/ruginiu	3-97348100	ruginiu	lumina alba calda	40/1	
00-022/gri	3-973460	gri	lumina alba rece	40/1	
00-022/satinat	3-9734660	satinat	lumina alba rece	40/1	
00-022/antic	3-973470	auriu antic	lumina alba rece	40/1	
00-022/rustic	3-9734710	auriu rustic	lumina alba rece	40/1	
00-022/ruginiu	3-9734810	ruginiu	lumina alba rece	40/1	
00-023/gri	3-973464	gri	lumina albastra	40/1	
00-023/satinat	3-9734664	satinat	lumina albastra	40/1	

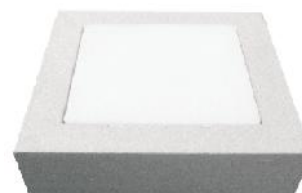

corp de iluminat dreptunghiular aluminiu (9736) aparent cu 10 leduri 0.6W					
L:121mm W:51mm h:25mm					
00-024/gri	3-9736600	gri	lumina alba calda	40/1	
00-024/satinat	3-97366600	satinat	lumina alba calda	40/1	
00-024/antic	3-9736700	auriu antic	lumina alba calda	40/1	
00-024/rustic	3-97367100	auriu rustic	lumina alba calda	40/1	
00-024/ruginiu	3-97368100	ruginiu	lumina alba calda	40/1	
00-025/gri	3-973660	gri	lumina alba rece	40/1	
00-025/satinat	3-9736660	satinat	lumina alba rece	40/1	
00-025/antic	3-973670	auriu antic	lumina alba rece	40/1	
00-025/rustic	3-9736710	auriu rustic	lumina alba rece	40/1	
00-025/ruginiu	3-9736810	ruginiu	lumina alba rece	40/1	
00-026/gri	3-973664	gri	lumina albastra	40/1	
00-026/satinat	3-9736664	satinat	lumina albastra	40/1	



CULORI DISPONIBILE:



GRI SATINAT ANTIC RUSTIC RUGINIU

COD DABLEROM	COD PRODUCATOR	DENUMIRE		PAC.	PRET €
corp de iluminat rotund aluminiu (9091) aparent cu 36 leduri 2.4W					
D:140mm h:55mm					
00-077/gri	3-909160	gri	lumina alba calda	30/1	
00-077/satinat	3-9091660	satinat	lumina alba calda	30/1	
00-077/antic	3-909170	auriu antic	lumina alba calda	30/1	
00-077/rustic	3-9091710	auriu rustic	lumina alba calda	30/1	
00-077/ruginiu	3-90917810	ruginiu	lumina alba calda	30/1	
00-078/gri	3-9091600	gri	lumina alba rece	30/1	
00-078/satinat	3-90916600	satinat	lumina alba rece	30/1	
00-078/antic	3-9091700	auriu antic	lumina alba rece	30/1	
00-078/rustic	3-90917100	auriu rustic	lumina alba rece	30/1	
00-078/ruginiu	3-909178100	ruginiu	lumina alba rece	30/1	
00-079/gri	3-909164	gri	lumina albastra	30/1	
00-079/satinat	3-9091664	satinat	lumina albastra	30/1	

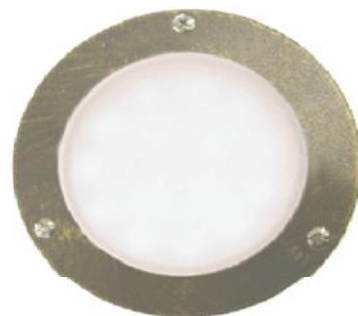

corp de iluminat rotund aluminiu (9092) aparent cu 15 leduri 1W					
D:140mm h:55mm					
00-100/gri	3-909260	gri	lumina alba calda	30/1	
00-100/satinat	3-9092660	satinat	lumina alba calda	30/1	
00-100/antic	3-909270	auriu antic	lumina alba calda	30/1	
00-100/rustic	3-9092710	auriu rustic	lumina alba calda	30/1	
00-100/ruginiu	3-90927810	ruginiu	lumina alba calda	30/1	
00-101/satinat	3-90926600	satinat	lumina alba rece	30/1	
00-101/antic	3-9092700	auriu antic	lumina alba rece	30/1	
00-101/rustic	3-90927100	auriu rustic	lumina alba rece	30/1	
00-101/ruginiu	3-909278100	ruginiu	lumina alba rece	30/1	
00-102/gri	3-909264	gri	lumina albastra	30/1	
00-102/satinat	3-9092664	satinat	lumina albastra	30/1	



corp de iluminat rotund aluminiu (9094) aparent cu 36 leduri 2.4W					
D:140mm h:55mm					
00-105/gri	3-909460	gri	lumina alba calda	30/1	
00-105/satinat	3-9094660	satinat	lumina alba calda	30/1	
00-105/antic	3-909470	auriu antic	lumina alba calda	30/1	
00-105/rustic	3-9094710	auriu rustic	lumina alba calda	30/1	
00-105/ruginiu	3-90947810	ruginiu	lumina alba calda	30/1	
00-106/gri	3-9094600	gri	lumina alba rece	30/1	
00-106/satinat	3-90946600	satinat	lumina alba rece	30/1	
00-106/antic	3-9094700	auriu antic	lumina alba rece	30/1	
00-106/rustic	3-90947100	auriu rustic	lumina alba rece	30/1	
00-106/ruginiu	3-909478100	ruginiu	lumina alba rece	30/1	
00-107/gri	3-909464	gri	lumina albastra	30/1	
00-107/satinat	3-9094664	satinat	lumina albastra	30/1	



CULORI DISPONIBILE:



GRI SATINAT ANTIC RUSTIC RUGINIU



COD DABLEROM	COD PRODUCATOR	DENUMIRE	PAC.	PRET €
corp de iluminat rotund aluminiu (9721) aparent G9 D:150mm h:60mm				
00-080/alb	3-97210	alb	30/1	
00-080/negru	3-97211	negru	30/1	
00-080/gri	3-97216	gri	30/1	
00-080/satinat	3-972166	satinat	30/1	
00-080/antic	3-97217	auriu antic	30/1	
00-080/rustic	3-972171	auriu rustic	30/1	
00-080/ruginiu	3-972181	ruginiu	30/1	



corp de iluminat rotund aluminiu (9722) aparent G9 D:150mm h:60mm				
00-103/alb	3-97220	alb	30/1	
00-103/negru	3-97221	negru	30/1	
00-103/gri	3-97226	gri	30/1	
00-103/satinat	3-972266	satinat	30/1	
00-103/antic	3-97227	auriu antic	30/1	
00-103/rustic	3-972271	auriu rustic	30/1	
00-103/ruginiu	3-972281	ruginiu	30/1	

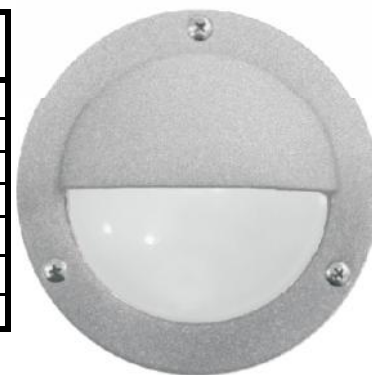

corp de iluminat rotund aluminiu (9723) aparent G9 D:150mm h:60mm				
00-108/alb	3-97230	alb	30/1	
00-108/negru	3-97231	negru	30/1	
00-108/gri	3-97236	gri	30/1	
00-108/satinat	3-972366	satinat	30/1	
00-108/antic	3-97237	auriu antic	30/1	
00-108/rustic	3-972371	auriu rustic	30/1	
00-108/ruginiu	3-972381	ruginiu	30/1	



CULORI DISPONIBILE:





COD DABLEROM	COD PRODUCATOR	DENUMIRE	PAC.	PRET €
corp de iluminat rotund aluminiu (9724) aparent GX53 D:150mm h:60mm				
00-081/alb	3-97240	alb	30/1	
00-081/negru	3-97241	negru	30/1	
00-081/gri	3-97246	gri	30/1	
00-081/satinat	3-972466	satinat	30/1	
00-081/antic	3-97247	auriu antic	30/1	
00-081/rustic	3-972471	auriu rustic	30/1	
00-081/ruginiu	3-972481	ruginiu	30/1	



corp de iluminat rotund aluminiu (90925) aparent GX53 max 7W D:150mm h:60mm				
00-104/alb	3-9092530	alb	30/1	
00-104/negru	3-9092531	negru	30/1	
00-104/gri	3-9092536	gri	30/1	
00-104/satinat	3-90925366	satinat	30/1	
00-104/antic	3-9092537	auriu antic	30/1	
00-104/rustic	3-90925371	auriu rustic	30/1	
00-104/ruginiu	3-90925378	ruginiu	30/1	



corp de iluminat rotund aluminiu (9726) aparent GX53 D:150mm h:60mm				
00-109/alb	3-97260	alb	30/1	
00-109/negru	3-97261	negru	30/1	
00-109/gri	3-97266	gri	30/1	
00-109/satinat	3-972666	satinat	30/1	
00-109/antic	3-97267	auriu antic	30/1	
00-109/rustic	3-972671	auriu rustic	30/1	
00-109/ruginiu	3-972681	ruginiu	30/1	



CULORI DISPONIBILE:



COD DABLEROM	COD PRODUCATOR	DENUMIRE		PAC.	PRET €
corp de iluminat aluminiu (9095) aparent cu 12 leduri 1W					
L:90mm W:60mm h:48mm					
00-945/cald	3-9095660	satinat	lumina alba calda	40/1	
00-946/cald	3-9095710	auriu rustic	lumina alba calda	40/1	
00-947/cald	3-90957810	ruginiu	lumina alba calda	40/1	
00-944/rece	3-9095600	gri	lumina alba rece	40/1	
00-945/rece	3-90956600	satinat	lumina alba rece	40/1	
00-946/rece	3-90957100	auriu rustic	lumina alba rece	40/1	
00-947/rece	3-909578100	ruginiu	lumina alba rece	40/1	
00-944/albastru	3-909564	gri	lumina albastra	40/1	
00-945/albastru	3-9095664	satinat	lumina albastra	40/1	

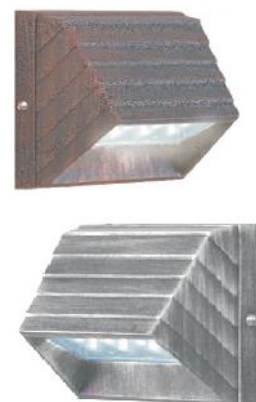

corp de iluminat aluminiu (90950) aparent cu 10 leduri 2W					
L:90mm W:60mm h:38mm					
00-9410/gri	3-9095060	gri	lumina alba calda	40/1	
00-9410/antic	3-9095070	auriu antic	lumina alba calda	40/1	
00-9410/rustic	3-90950710	auriu rustic	lumina alba calda	40/1	
00-9410/ruginiu	3-90950810	ruginiu	lumina alba calda	40/1	
00-9420/gri	3-90950600	gri	lumina alba rece	40/1	
00-9420/satinat	3-909506600	satinat	lumina alba rece	40/1	
00-9420/antic	3-90950700	auriu antic	lumina alba rece	40/1	
00-9420/rustic	3-909507100	auriu rustic	lumina alba rece	40/1	
00-9420/ruginiu	3-909508100	ruginiu	lumina alba rece	40/1	



corp de iluminat aluminiu (9772) aparent cu 4 leduri (lumina in patru sensuri)					
D:45mm h:16mm					
00-822/cald	3-97726600	satinat	lumina alba calda	60/1	
00-822/rece	3-9772660	satinat	lumina alba rece	60/1	
00-822/rosu	3-9772662	satinat	lumina rosie	60/1	
00-822/portocaliu	3-9772663	satinat	lumina portocalie	60/1	
00-822/albastru	3-9772664	satinat	lumina albastra	60/1	
00-822/verde	3-9772665	satinat	lumina verde	60/1	
00-8227/cald	3-9772700	auriu antic	lumina alba calda	60/1	
00-8227/rece	3-977270	auriu antic	lumina alba rece	60/1	



CORPURI DE ILUMINAT "PT" PENTRU BEC G9 IP54

COD DABLEROM	COD PRODUCATOR	DENUMIRE		PAC.	PRET €
corp de iluminat aluminiu (7225) aparent pentru bec G9 (lumina in opt sensuri)					
D:120mm h:120mm					
00-835/gri	9-72256	gri		1	

CULORI DISPONIBILE:



COD DABLEROM	COD PRODUCATOR	DENUMIRE		PAC.	PRET €
corp de iluminat aluminiu (7015) aparent cu 20 leduri 1.6W (lumina intr-un singur sens) L:220mm W:90mm h:60mm					
00-154/negru	9-70156100	negru	lumina alba calda	12/1	
00-154/gri	9-70156600	gri	lumina alba calda	12/1	
00-154/satinat	9-701566600	satinat	lumina alba calda	12/1	
00-154/rustic	9-701567100	auriu rustic	lumina alba calda	12/1	
00-154/ruginiu	9-7015678100	ruginiu	lumina alba calda	12/1	
00-155/negru	9-7015610	negru	lumina alba rece	12/1	
00-155/gri	9-7015660	gri	lumina alba rece	12/1	
00-155/satinat	9-70156660	satinat	lumina alba rece	12/1	
00-155/rustic	9-70156710	auriu rustic	lumina alba rece	12/1	
00-155/ruginiu	9-701567810	ruginiu	lumina alba rece	12/1	
00-156/gri	9-7015664	gri	lumina albastra	12/1	
00-156/satinat	9-70156664	satinat	lumina albastra	12/1	



COD DABLEROM	COD PRODUCATOR	DENUMIRE		PAC.	PRET €
corp de iluminat aluminiu (70056) aparent cu 40 leduri 3.3W (lumina in ambele sensuri) L:220mm W:90mm h:60mm					
00-157/negru	9-70056100	negru	lumina alba calda	12/1	
00-157/gri	9-70056600	gri	lumina alba calda	12/1	
00-157/satinat	9-700566600	satinat	lumina alba calda	12/1	
00-157/rustic	9-700567100	auriu rustic	lumina alba calda	12/1	
00-157/ruginiu	9-7005678100	ruginiu	lumina alba calda	12/1	
00-158/negru	9-7005610	negru	lumina alba rece	12/1	
00-158/gri	9-7005660	gri	lumina alba rece	12/1	
00-158/satinat	9-70056660	satinat	lumina alba rece	12/1	
00-158/rustic	9-70056710	auriu rustic	lumina alba rece	12/1	
00-158/ruginiu	9-700567810	ruginiu	lumina alba rece	12/1	
00-159/gri	9-7005664	gri	lumina albastra	12/1	
00-159/satinat	9-70056664	satinat	lumina albastra	12/1	



CULORI DISPONIBILE:



COD DABLEROM	COD PRODUCATOR	DENUMIRE		PAC.	PRET €
corp de iluminat aluminiu (7059) aparent cu 24 leduri 1.6W (lumina intr-un singur sens)					
L:180mm W:80mm h:60mm					
00-206/gri	9-7059600	gri	lumina alba calda	12/1	
00-206/satinat	9-70596600	satinat	lumina alba calda	12/1	
00-206/rustic	9-70597100	auriu rustic	lumina alba calda	12/1	
00-206/ruginiu	9-705978100	ruginiu	lumina alba calda	12/1	
00-207/negru	9-705910	negru	lumina alba rece	12/1	
00-207/gri	9-705960	gri	lumina alba rece	12/1	
00-207/satinat	9-7059660	satinat	lumina alba rece	12/1	
00-207/rustic	9-7059710	auriu rustic	lumina alba rece	12/1	
00-207/ruginiu	9-70597810	ruginiu	lumina alba rece	12/1	
00-208/gri	9-705964	gri	lumina albastra	12/1	
00-208/satinat	9-7059664	satinat	lumina albastra	12/1	



corp de iluminat aluminiu (7060B) aparent cu 40 leduri 3.3W (lumina in ambele sensuri)					
L:180mm W:80mm h:60mm					
00-209/negru	9-7060100	negru	lumina alba calda	12/1	
00-209/gri	9-7060600	gri	lumina alba calda	12/1	
00-209/satinat	9-70606600	satinat	lumina alba calda	12/1	
00-209/rustic	9-70607100	auriu rustic	lumina alba calda	12/1	
00-209/ruginiu	9-706078100	ruginiu	lumina alba calda	12/1	
00-210/negru	9-706010	negru	lumina alba rece	12/1	
00-210/gri	9-706060	gri	lumina alba rece	12/1	
00-210/satinat	9-7060660	satinat	lumina alba rece	12/1	
00-210/rustic	9-7060710	auriu rustic	lumina alba rece	12/1	
00-210/ruginiu	9-70607810	ruginiu	lumina alba rece	12/1	
00-211/gri	9-706064	gri	lumina albastra	12/1	
00-211/satinat	9-7060664	satinat	lumina albastra	12/1	

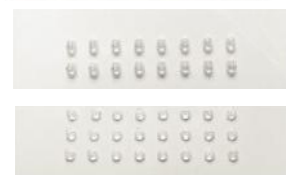

CULORI DISPONIBILE:



NEGRU GRI SATINAT RUSTIC RUGINIU

CORPURI DE ILUMINAT "PT" PENTRU BEC G9 230V IP54

30



COD DABLEROM	COD PRODUCATOR	DENUMIRE	PAC.	PRET €
corp de iluminat aluminiu (9098) aparent pentru bec G9 (lumina intr-un singur sens) L:120mm D:110mm				
00-925	3-90986	gri	18/1	
00-926	3-909866	satinat	18/1	
00-9261	3-909871	auriu rustic	18/1	
00-9268	3-9098781	ruginiu	18/1	

corp de iluminat aluminiu (9101) aparent pentru bec G9 (lumina intr-un singur sens) L:145mm W:45mm h:120mm				
00-927	3-91016	gri	18/1	
00-9287	3-91017	auriu antic	18/1	
00-928	3-910166	satinat	18/1	
00-9288	3-9101781	ruginiu	18/1	



corp de iluminat aluminiu (9102) aparent pentru bec G9 (lumina in ambele sensuri) L:145mm W:45mm h:120mm				
00-927/2	3-91026	gri	18/1	
00-9287/2	3-91027	auriu antic	18/1	
00-928/2	3-910266	satinat	18/1	
00-9288/2	3-9102781	ruginiu	18/1	



CULORI DISPONIBILE:



GRI SATINAT ANTIC RUGINIU



CORPURI DE ILUMINAT "PT" CU POWER LED 230V IP54

COD DABLEROM	COD PRODUCATOR	DENUMIRE	PAC.	PRET €
corp de iluminat aluminiu (9222) aparent cu 1 power led 1W (lumina intr-un singur sens) L:62mm W:46mm h:35mm				
00-832/cald	3-92226600	argintiu lumina alba calda	30/1	
00-832/rece	3-9222660	argintiu lumina alba rece	30/1	
00-832/albastru	3-9222664	argintiu lumina albastra	30/1	
00-8327/cald	3-9222700	auriu antic lumina alba calda	30/1	
00-8327/rece	3-922270	auriu antic lumina alba rece	30/1	



CULORI DISPONIBILE:



ARGINTIU ANTIC

corp de iluminat aluminiu (9221) aparent cu 2 power leduri 2W (lumina in ambele sensuri) L:85mm W:46mm h:35mm				
00-833/cald	3-92216600	argintiu lumina alba calda	30/1	
00-833/rece	3-9221660	argintiu lumina alba rece	30/1	
00-833/albastru	3-9221664	argintiu lumina albastra	30/1	
00-8337/cald	3-9221700	auriu antic lumina alba calda	30/1	
00-8337/rece	3-922170	auriu antic lumina alba rece	30/1	



februarie 2012

CORPURI DE ILUMINAT "PT" PENTRU BEC GU10 230V IP44

31

COD DABLEROM	COD PRODUCATOR	DENUMIRE	PAC.	PRET €
corp de iluminat aluminiu (9041) aparent pentru bec GU10 (lumina intr-un singur sens) L:180mm D:90mm				
00-212/gri	9-90416	gri	12/1	
00-212/satinat	9-904166	satinat	12/1	
00-212/antic	9-90417	auriu antic	12/1	
00-212/rustic	9-904171	auriu rustic	12/1	
00-212/ruginiu	9-9041781	ruginiu	12/1	



corp de iluminat aluminiu (9042) aparent pentru becuri GU10 (lumina in ambele sensuri) L:300mm D:90mm				
00-213/gri	9-90426	gri	12/1	
00-213/satinat	9-904266	satinat	12/1	
00-213/antic	9-90427	auriu antic	12/1	
00-213/rustic	9-904271	auriu rustic	12/1	
00-213/ruginiu	9-9042781	ruginiu	12/1	



CORPURI DE ILUMINAT "PT" PENTRU BEC E27(D:90mm) 230V IP44

COD DABLEROM	COD PRODUCATOR	DENUMIRE	PAC.	PRET €
corp de iluminat aluminiu (9043) aparent pentru bec E27-R63 (lumina intr-un singur sens) L:180mm D:90mm				
00-921	9-90436	gri	12/1	
00-922	9-904366	satinat	12/1	
00-9227	9-90437	auriu antic	12/1	
00-9221	9-904371	auriu rustic	12/1	
00-9228	9-9043781	ruginiu	12/1	



corp de iluminat aluminiu (9046) aparent pentru becuri E27-R63 (lumina in ambele sensuri) L:300mm D:90mm				
00-921/2	9-90466	gri	12/1	
00-922/2	9-904666	satinat	12/1	
00-9227/2	9-90467	auriu antic	12/1	
00-9221/2	9-904671	auriu rustic	12/1	
00-9228/2	9-9046781	ruginiu	12/1	

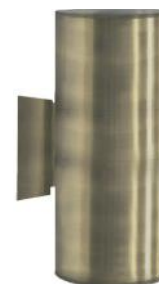

CORPURI DE ILUMINAT "PT" PENTRU BEC E27(D:108mm) 230V IP44

COD DABLEROM	COD PRODUCATOR	DENUMIRE	PAC.	PRET €
corp de iluminat aluminiu (9044) aparent pentru bec E27-R80 (lumina intr-un singur sens) L:200mm D:108mm				
00-923	9-90446	gri	12/1	
00-924	9-904466	satinat	12/1	
00-9247	9-90447	auriu antic	12/1	
00-9241	9-904471	auriu rustic	12/1	
00-9248	9-9044781	ruginiu	12/1	



corp de iluminat aluminiu (9047) aparent pentru becuri E27-R80 (lumina in ambele sensuri) L:300mm D:108mm				
00-923/2	9-90476	gri	12/1	
00-924/2	9-904766	satinat	12/1	
00-9247/2	9-90477	auriu antic	12/1	
00-9241/2	9-904771	auriu rustic	12/1	
00-9248/2	9-9047781	ruginiu	12/1	



CULORI DISPONIBILE:



GRI SATINAT ANTIC RUSTIC RUGINIU

februarie 2012

COD DABLEROM	COD PRODUCATOR	DENUMIRE	PAC.	PRET €
corp de iluminat patrat aluminiu (9161) aparent pentru bec GU10 (lumina intr-un singur sens)				
L:180mm D:63x63mm h:88mm				
00-931/alb	3-916110	alb	18/1	
00-931/negru	3-916111	negru	18/1	
00-931/gri	3-916116	gri	18/1	
00-931/satinat	3-9161166	satinat	18/1	
00-931/antic	3-916117	auriu antic	18/1	
00-931/rustic	3-9161171	auriu rustic	18/1	
00-931/ruginiu	3-9161181	ruginiu	18/1	



COD DABLEROM	COD PRODUCATOR	DENUMIRE	PAC.	PRET €
corp de iluminat patrat aluminiu (9061) aparent pentru bec GU10 (lumina in ambele sensuri)				
L:195mm D:63x63mm h:85mm				
00-932/alb	3-906120	alb	18/1	
00-932/negru	3-906121	negru	18/1	
00-932/gri	3-906126	gri	18/1	
00-932/satinat	3-9061266	satinat	18/1	
00-932/antic	3-906127	auriu antic	18/1	
00-932/rustic	3-9061271	auriu rustic	18/1	
00-932/ruginiu	3-9061281	ruginiu	18/1	



CORPURI DE ILUMINAT "PT" PENTRU BEC E27 230V IP44

COD DABLEROM	COD PRODUCATOR	DENUMIRE	PAC.	PRET €
corp de iluminat patrat aluminiu (7163) aparent pentru bec E27-R80 (lumina intr-un singur sens)				
L:200mm W:175mm D:108x108mm				
00-933/gri	9-71636	gri	12/1	
00-933/satinat	9-716366	satinat	12/1	
00-933/antic	9-71637	auriu antic	12/1	
00-933/rustic	9-716371	auriu rustic	12/1	
00-933/ruginiu	9-716381	ruginiu	12/1	



COD DABLEROM	COD PRODUCATOR	DENUMIRE	PAC.	PRET €
corp de iluminat patrat aluminiu (7164) aparent pentru bec E27-R80 (lumina in ambele sensuri)				
L:300mm W:175mm D:108x108mm				
00-934/gri	9-71646	gri	12/1	
00-934/antic	9-71647	auriu antic	12/1	
00-934/rustic	9-716471	auriu rustic	12/1	
00-934/ruginiu	9-716481	ruginiu	12/1	



CULORI DISPONIBILE:



CORPURI DE ILUMINAT "PT" PENTRU BEC GU10 230V IP54

33

COD DABLEROM	COD PRODUCATOR	DENUMIRE	PAC.	PRET €
corp de iluminat aluminiu (1011) aparent pentru bec GU10 (lumina intr-un singur sens) L:168mm D:63mm				
00-950	3-101100	alb	20/1	
00-951	3-101101	negru	20/1	
00-952	3-101106	gri	20/1	
00-953	3-1011066	satinat	20/1	
00-9547	3-101107	auriu antic	20/1	
00-954	3-1011071	auriu rustic	20/1	
00-955	3-10110781	ruginiu	20/1	



corp de iluminat aluminiu (1111) aparent pentru bec GU10 (lumina intr-un singur sens) L:106mm D:60mm h:90mm				
00-950/1	3-111100	alb	20/1	
00-951/1	3-111101	negru	20/1	
00-952/1	3-111106	gri	20/1	
00-953/1	3-1111066	satinat	20/1	
00-9547/1	3-111107	auriu antic	20/1	
00-954/1	3-1111071	auriu rustic	20/1	
00-955/1	3-11110781	ruginiu	20/1	



corp de iluminat aluminiu (1121) aparent pentru bec GU10 (lumina in ambele sensuri) L:187mm D:60mm h:90mm				
00-950/2	3-112100	alb	20/1	
00-951/2	3-112101	negru	20/1	
00-952/2	3-112106	gri	20/1	
00-953/2	3-1121066	satinat	20/1	
00-9547/2	3-112107	auriu antic	20/1	
00-954/2	3-1121071	auriu rustic	20/1	
00-955/2	3-11210781	ruginiu	20/1	



CULORI DISPONIBILE:



CORPURI DE ILUMINAT "ST" PENTRU PARDOSEALA IP65

COD DABLEROM	COD PRODUCATOR	DENUMIRE	PAC.	PRET €
corp de iluminat INOX 316 incastrat (lumina in ambele sensuri) D:88mm h:110mm Ø70mm				
00-990/GU10	4-9042202	crom pentu bec GU10	18/1	
00-990/MR16	4-904122	crom pentu bec MR16	18/1	



corp de iluminat INOX 316 incastrat (lumina in patru sensuri) D:88mm h:110mm Ø70mm				
00-991/GU10	4-9042204	crom pentu bec GU10	18/1	
00-991/MR16	4-904124	crom pentu bec MR16	18/1	



februarie 2012

COD DABLEROM	COD PRODUCATOR	DENUMIRE	PAC.	PRET €
corp de iluminat aluminiu (9041) aparent pentru bec MR16/50mm IP65 L:103mm D:98mm				
00-982	4-904120	alb	40/1	
00-983	4-904121	negru	40/1	
00-984	4-904126	gri	40/1	
00-985	4-904123	satinat	40/1	
00-986	4-9041271	auriu rustic	40/1	
00-987	4-90412781	ruginiu	40/1	
00-988	4-904125	verde	40/1	



corp de iluminat aluminiu (9042) aparent pentru bec GU10 IP65 L:103mm D:98mm				
00-982/GU10	4-9042200	alb	40/1	
00-983/GU10	4-9042201	negru	40/1	
00-984/GU10	4-9042206	gri	40/1	
00-985/GU10	4-9042203	satinat	40/1	
00-986/GU10	4-90422071	auriu rustic	40/1	
00-987/GU10	4-904220781	ruginiu	40/1	
00-988/GU10	4-9042205	verde	40/1	



grilaj pentru 9041 & 9042 D:98mm				
00-982/1	4-9040	alb	1	
00-983/1	4-9041	negru	1	
00-984/1	4-9046	gri	1	
00-985/1	4-9043	satinat	1	
00-986/1	4-90471	auriu rustic	1	
00-987/1	4-904781	ruginiu	1	
00-988/1	4-9045	verde	1	



guler pentru 9041 & 9042 D:98mm				
00-982/2	4-90500	alb	1	
00-983/2	4-90510	negru	1	
00-984/2	4-90560	gri	1	
00-985/2	4-90530	satinat	1	
00-986/2	4-905710	auriu rustic	1	
00-987/2	4-90578100	ruginiu	1	
00-988/2	4-90550	verde	1	



tarus pentru 9041 & 9042 L:170mm				
00-989	4-904	negru	1	



CULORI DISPONIBILE:



CORPURI DE ILUMINAT DE GRADINA PENTRU BEC GU10 IP54

35



COD DABLEROM	COD PRODUCATOR	DENUMIRE	PAC.	PRET €
aplica aluminiu (9106) pentru bec GU10 (lumina indirecta) h:14cm D:150mm W:110mm h:140mm				
00-484	9-91066	gri	18/1	
00-4846	9-910666	satinat	18/1	
00-4841	9-910671	auriu rustic	18/1	
00-4848	9-910681	ruginiu	18/1	

stalp aluminiu (91072) pentru bec GU10 (lumina indirecta) h:20cm D1:65mm D2:120mm h:200mm				
00-484/20	9-9107206	gri	18/1	
00-4846/20	9-91072066	satinat	18/1	
00-4841/20	9-91072071	auriu rustic	18/1	
00-4848/20	9-91072081	ruginiu	18/1	



stalp aluminiu (91076) pentru bec GU10 (lumina indirecta) h:65cm D1:65mm D2:120mm h:650mm				
00-484/65	9-9107656	gri	6/1	
00-4846/65	9-91076566	satinat	6/1	
00-4841/65	9-91076571	auriu rustic	6/1	
00-4848/65	9-910765781	ruginiu	6/1	

CORPURI DE ILUMINAT DE GRADINA PENTRU BEC E27 IP44

COD DABLEROM	COD PRODUCATOR	DENUMIRE	PAC.	PRET €
aplica aluminiu oval (9022) pentru bec E27 - h:26cm D:125mm W:145mm h:260mm				
00-910	9-9022310	alb	8/1	
00-911	9-9022316	gri	8/1	
00-912	9-90223166	satinat	8/1	
00-913	9-90223171	auriu rustic	8/1	
00-914	9-902231781	ruginiu	8/1	



stalp aluminiu oval (9023) pentru bec E27 - h:30cm D:162mm W:145mm h:300mm				
00-912/30	9-90233066	satinat	4/1	
00-913/30	9-90233071	auriu rustic	4/1	
00-914/30	9-90233081	ruginiu	4/1	

stalp aluminiu oval (9023) pentru bec E27 - h:65cm D:162mm W:145mm h:650mm				
00-910/65	9-9023650	alb	4/1	
00-911/65	9-9023656	gri	4/1	
00-912/65	9-90236566	satinat	4/1	
00-913/65	9-90236571	auriu rustic	4/1	
00-914/65	9-90236581	ruginiu	4/1	



CULORI DISPONIBILE:



ALB GRI SATINAT RUSTIC RUGINIU

februarie 2012



COD DABLEROM	COD PRODUCATOR	DENUMIRE	PAC.	PRET €
aplica aluminiu (9013) pentru bec E27 - h:22cm D:65mm W:110mm h:220mm				
00-902	9-90130	alb	18/1	
00-903	9-90136	gri	18/1	
00-904	9-901371	auriu rustic	18/1	
00-905	9-9013781	ruginiu	18/1	



aplica aluminiu (9113) pentru bec E27 - h:37cm D:65mm h:370mm				
00-902/1	9-91130	alb	18/1	
00-903/1	9-91136	gri	18/1	
00-904/1	9-911371	auriu rustic	18/1	
00-905/1	9-9113781	ruginiu	18/1	



stalp aluminiu (90144) pentru bec E27 - h:45cm D1:65mm D2:120mm h:450mm				
00-902/45	9-9014450	alb	6/1	
00-903/45	9-9014456	gri	6/1	
00-904/45	9-90144571	auriu rustic	6/1	
00-905/45	9-901445781	ruginiu	6/1	



stalp aluminiu (90146) pentru bec E27 - h:65cm D1:65mm D2:120mm h:650mm				
00-902/65	9-9014650	alb	6/1	
00-903/65	9-9014656	gri	6/1	
00-904/65	9-90146571	auriu rustic	6/1	
00-905/65	9-90146581	ruginiu	6/1	

stalp aluminiu (90263) pentru bec E27 - h:37cm D1:65mm D2:110mm h:370mm				
00-906/37	9-9026370	alb	9/1	
00-907/37	9-9026376	gri	9/1	
00-908/37	9-90263771	auriu rustic	9/1	
00-909/37	9-90263781	ruginiu	9/1	



stalp aluminiu (90266) pentru bec E27 - h:65cm D1:65mm D2:110mm h:650mm				
00-906/65	9-9026650	alb	4/1	
00-907/65	9-9026656	gri	4/1	
00-908/65	9-90266571	auriu rustic	4/1	
00-909/65	9-90266581	ruginiu	4/1	

CULORI DISPONIBILE:



ALB GRI RUSTIC RUGINIU



COD DABLEROM	COD PRODUCATOR	DENUMIRE	PAC.	PRET €
aplica aluminiu (7111) pentru bec E27 - h:24cm D:90mm W:155mm h:240mm				
00-418	9-71116	gri	12/1	
00-4181	9-711171	auriu rustic	12/1	
00-4188	9-711181	ruginiu	12/1	



stalp aluminiu (7114) pentru bec E27 - h:30cm D1:90mm D2:140mm h:300mm				
00-418/30	9-71146	gri	8/1	
00-4181/30	9-711471	auriu rustic	8/1	
00-4188/30	9-711481	ruginiu	8/1	



stalp aluminiu (7113) pentru bec E27 - h:65cm D1:90mm D2:140mm h:650mm				
00-418/65	9-71136	gri	4/1	
00-4181/65	9-711371	auriu rustic	4/1	
00-4188/65	9-711381	ruginiu	4/1	

stalp aluminiu (7113) pentru bec E27 - h:100cm D1:90mm D2:140mm h:1000mm				
00-418/100	9-711336	gri	4/1	
00-4181/100	9-7113371	auriu rustic	4/1	
00-4188/100	9-71133781	ruginiu	4/1	

aplica aluminiu (9034) pentru bec E27 - h:21cm D:90mm W:155mm h:210mm				
00-919	9-90346	gri	12/1	
00-920	9-903466	satinat	12/1	
00-9201	9-903471	auriu rustic	12/1	
00-9208	9-903481	ruginiu	12/1	



stalp aluminiu (9040) pentru bec E27 - h:65cm D1:90mm D2:140mm h:650mm				
00-919/65	9-90406	gri	6/1	
00-920/65	9-904066	satinat	6/1	
00-9201/65	9-904071	auriu rustic	6/1	
00-9208/65	9-904081	ruginiu	6/1	



CULORI DISPONIBILE:



GRI SATINAT RUSTIC RUGINIU



COD DABLEROM	COD PRODUCATOR	DENUMIRE	PAC.	PRET €
aplica aluminiu (7212) pentru bec E27 - h:26cm D:70x70mm h:260mm				
00-425/gri	9-72126	gri	18/1	
00-425/rustic	9-721271	auriu rustic	18/1	
00-425/ruginiu	9-721281	ruginiu	18/1	



aplica aluminiu (7211) pentru bec E27 - h:22cm D:70x70mm W:122mm h:220mm				
00-426/gri	9-72116	gri	18/1	
00-426/rustic	9-721171	auriu rustic	18/1	
00-426/ruginiu	9-721181	ruginiu	18/1	

stalp aluminiu (7213-23) pentru bec E27 - h:23cm D1:70x70mm D2:120x120mm h:230mm				
00-427/23	9-7213236	gri	8/1	
00-4271/23	9-72132371	auriu rustic	8/1	
00-4278/23	9-72132381	ruginiu	8/1	



stalp aluminiu (7213-65) pentru bec E27 - h:65cm D1:70x70mm D2:120x120mm h:650mm				
00-427/65	9-7213656	gri	6/1	
00-4271/65	9-72136571	auriu rustic	6/1	
00-4278/65	9-72136581	ruginiu	6/1	



stalp aluminiu (7213-100) pentru bec E27 - h:100cm D1:70x70mm D2:120x120mm h:1000mm				
00-427/100	9-72131006	gri	4/1	
00-4271/100	9-721310071	auriu rustic	4/1	
00-4278/100	9-721310081	ruginiu	4/1	



stalp aluminiu (7214) pentru bec E27 - h:37cm D:70x70mm h:370mm				
00-428/37	9-72146	gri	4/1	
00-4281/37	9-721471	auriu rustic	4/1	
00-4288/37	9-721481	ruginiu	4/1	



CULORI DISPONIBILE:



GRI RUSTIC RUGINIU

COD DABLEROM	COD PRODUCATOR	DENUMIRE	PAC.	PRET €
aplica aluminiu (7232) pentru bec E14 - h:13cm D:110x110mm h:130mm				
00-466/gri	9-7232136	gri	18/1	
00-466/satinat	9-72321366	satinat	18/1	
00-466/antic	9-7232137	auriu antic	18/1	
00-466/rustic	9-72321371	auriu rustic	18/1	
00-466/ruginiu	9-72321381	ruginiu	18/1	



aplica aluminiu (7234) pentru bec E27 - h:22cm D:110x110mm W:122mm h:220mm				
00-467/gri	9-72346	gri	12/1	
00-467/satinat	9-723466	satinat	12/1	
00-467/antic	9-72347	auriu antic	12/1	
00-467/rustic	9-723471	auriu rustic	12/1	
00-467/ruginiu	9-723481	ruginiu	12/1	



stalp aluminiu (7233-20) pentru bec E27 - h:20cm D:110x110mm h:200mm				
00-468/20	9-7233206	gri	12/1	
00-4686/20	9-72332066	satinat	12/1	
00-4687/20	9-7233207	auriu antic	12/1	
00-4681/20	9-72332071	auriu rustic	12/1	
00-4688/20	9-72332081	ruginiu	12/1	

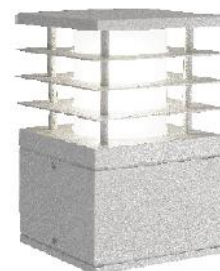

stalp aluminiu (7233-65) pentru bec E27 - h:65cm D:110x110mm h:650mm				
00-468/65	9-7233656	gri	4/1	
00-4686/65	9-72336566	satinat	4/1	
00-4687/65	9-7233657	auriu antic	4/1	
00-4681/65	9-72336571	auriu rustic	4/1	
00-4688/65	9-72336581	ruginiu	4/1	



stalp aluminiu (7233-100) pentru bec E27 - h:100cm D:110x110mm h:1000mm				
00-468/100	9-72336	gri	4/1	
00-4686/100	9-723366	satinat	4/1	
00-4681/100	9-723371	auriu rustic	4/1	
00-4688/100	9-723381	ruginiu	4/1	

CULORI DISPONIBILE:



GRI SATINAT ANTIC RUSTIC RUGINIU



COD DABLEROM	COD PRODUCATOR	DENUMIRE	PAC.	PRET €
aplica aluminiu dreptunghiulara (7271) pentru bec E27 (lumina in ambele sensuri) L:280mm W:70mm h:120mm				
00-433/negru	9-72711	negru	12/1	
00-433/gri	9-72716	gri	12/1	
00-433/rustic	9-727171	auriu rustic	12/1	
00-433/ruginiu	9-717281	ruginiu	12/1	



aplica aluminiu dreptunghiulara (7271-A) pentru bec E27 (lumina in ambele sensuri cu fanta) L:280mm W:70mm h:120mm				
00-434/negru	9-727111	negru	12/1	
00-434/gri	9-727116	gri	12/1	
00-434/rustic	9-7271171	auriu rustic	12/1	
00-434/ruginiu	9-7271181	ruginiu	12/1	

COD DABLEROM	COD PRODUCATOR	DENUMIRE	PAC.	PRET €
stalp aluminiu patrat (7273) pentru bec E27 - h:22cm L:150x150mm h:220mm				
00-435	9-7273201	negru	8/1	
00-4356	9-7273206	gri	8/1	
00-4351	9-72732071	auriu rustic	8/1	
00-4358	9-72732081	ruginiu	8/1	



stalp aluminiu patrat (7275-65) pentru bec E27 - h:65cm L:150x150mm h:650mm				
00-435/65	9-7275651	negru	2/1	
00-4356/65	9-7275656	gri	2/1	
00-4351/65	9-72756571	auriu rustic	2/1	
00-4358/65	9-72756581	ruginiu	2/1	



stalp aluminiu patrat (7275-90) pentru bec E27 - h:90cm L:150x150mm h:900mm				
00-435/90	9-7275901	negru	2/1	
00-4356/90	9-7275906	gri	2/1	
00-4351/90	9-72759071	auriu rustic	2/1	
00-4358/90	9-72759081	ruginiu	2/1	

CULORI DISPONIBILE:

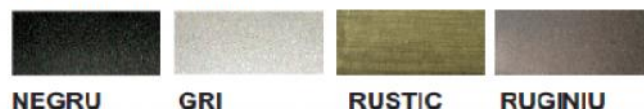

NEGRU GRI RUSTIC RUGINIU

CORPURI DE ILUMINAT DE GRADINA IP44

41

COD DABLEROM	COD PRODUCATOR	DENUMIRE	PAC.	PRET €
aplica aluminiu hexagonala (7292) pentru bec E14 - h:10.5cm D1:125mm D2:108mm h:105mm				
00-436	9-72926	gri	18/1	
00-4361	9-729271	auriu rustic	18/1	
00-4368	9-729281	ruginiu	18/1	



COD DABLEROM	COD PRODUCATOR	DENUMIRE	PAC.	PRET €
aplica aluminiu hexagonala (7294) pentru bec E27 - h:20cm D:125mm W:180mm h:200mm				
00-437	9-72946	gri	12/1	
00-4371	9-729471	auriu rustic	12/1	
00-4378	9-729481	ruginiu	12/1	



COD DABLEROM	COD PRODUCATOR	DENUMIRE	PAC.	PRET €
stalp aluminiu hexagonal (7293-20) pentru bec E27 - h:20cm D:125mm h:200mm				
00-436/20	9-7293200	gri	12/1	
00-4361/20	9-72932071	auriu rustic	12/1	
00-4368/20	9-72932081	ruginiu	12/1	



COD DABLEROM	COD PRODUCATOR	DENUMIRE	PAC.	PRET €
stalp aluminiu hexagonal (7293-65) pentru bec E27 - h:65cm D:125mm h:650mm				
00-436/65	9-7293656	gri	4/1	
00-4361/65	9-72936571	auriu rustic	4/1	
00-4368/65	9-72936581	ruginiu	4/1	

COD DABLEROM	COD PRODUCATOR	DENUMIRE	PAC.	PRET €
APLICA-STALP DIN ALUMINIU IP44				
aplica-stalp aluminiu rotund (7042) pentru bec E14 IP44 D:110mm W:130mm				
00-417/gri	9-70426	gri	18/1	
00-417/satinat	9-704266	satinat	18/1	
00-417/antic	9-70427	auriu antic	18/1	
00-417/rustic	9-704271	auriu rustic	18/1	
00-417/ruginiu	9-7042781	ruginiu	18/1	



COD DABLEROM	COD PRODUCATOR	DENUMIRE	PAC.	PRET €
APLICA DIN ALUMINIU IP54				
aplica aluminiu rotunda (7151) pentru bec E27 IP54 D:195mm h:130mm				
00-940/alb	3-71510	alb	8/1	
00-940/negru	3-71511	negru	8/1	
00-940/gri	3-71516	gri	8/1	
00-940/satinat	3-715166	satinat	8/1	
00-940/antic	3-71517	auriu antic	8/1	
00-940/rustic	3-715171	auriu rustic	8/1	
00-940/ruginiu	3-7151781	ruginiu	8/1	



CULORI DISPONIBILE:



ALB NEGRU GRI SATINAT ANTIC RUSTIC RUGINIU

februarie 2012



COD DABLEROM	COD PRODUCATOR	DENUMIRE	PAC.	PRET €
aplica INOX dreptunghiulara pentru bec E27 L:300mm W:225mm h:90mm				
00-900	4-922	INOX fara grilaj	12/1	
00-901	4-923	INOX cu grilaj	12/1	

aplica INOX cilindru pentru bec E27				
00-915/1	4-930	INOX D:75mm h:400mm	20/1	
00-915/2	4-9300	INOX D:75mm W:160mm h:380mm	12/1	



stalp INOX cilindru pentru bec E27				
00-915/30	4-921	INOX D1:75mm h:300mm	12/1	
00-915/45	4-931	INOX D1:75mm h:450mm	12/1	
00-915/65	4-932	INOX D1:75mm h:650mm	12/1	
00-915/100	4-933	INOX D1:75mm h:1100mm	6/1	



aplica INOX cilindru cu grilaj pentru bec E27				
00-916/1	4-935	INOX D1:120mm h:400mm	12/1	
00-916/2	4-934	INOX D1:120mm W:150mm h:380mm	12/1	



stalp INOX cilindru cu grilaj pentru bec E27				
00-916/30	4-926	INOX D1:120mm h:300mm	12/1	
00-916/45	4-936	INOX D1:120mm h:450mm	12/1	
00-916/65	4-937	INOX D1:120mm h:650mm	12/1	
00-916/110	4-938	INOX D1:120mm h:1100mm	6/1	



COD DABLEROM	COD PRODUCATOR	DENUMIRE	PAC.	PRET €
aplica INOX patrata pentru bec E27				
00-929	4-8021	INOX D:80x80mm h:380mm	20/1	
00-929/2	4-8022	INOX D:80x80mm W:145mm h:380mm	12/1	

stalp INOX patrata pentru bec E27				
00-929/30	4-802330	INOX D:80x80mm h:300mm	12/1	
00-929/65	4-802365	INOX D:80x80mm h:650mm	6/1	
00-926/110	4-8023110	INOX D:80x80mm h:1100mm	4/1	

aplica INOX cilindrica verticala pentru bec E27				
00-917/1	4-943	INOX D:75mm W:100mm h:375mm	12/1	
00-917/2	4-940	INOX D:75mm W:120mm h:480mm	12/1	

stalp INOX cilindru vertical pentru bec E27				
00-917/65	4-944	INOX D1:131mm h:650mm	12/1	
00-917/110	4-941	INOX D1:131mm h:1100mm	6/1	
00-917/140	4-942	INOX D1:131mm h:1400mm	4/1	

aplica INOX tip felinar pentru bec E27				
00-918/1	4-9440	INOX D:120mm W:220mm h:350mm	6/1	

stalp INOX tip felinar pentru bec E27				
00-918/50	4-945	INOX D1:75mm h:500mm	4/1	
00-918/105	4-946	INOX D1:75mm h:1050mm	4/1	



COD DABLEROM	COD PRODUCATOR	DENUMIRE	PAC.	PRET €
stalp tip felinar cu 2 LED (2 baterii de 1.2V 1200mAh) timp de incarcare 10 ore / timp de functionare 8 ore				
00-9940	5-105	negru - 2 LED lumina alba calda	12	

stalp - aplica tip felinar cu 3 LED (2 baterii de 1.5V 1500mAh) timp de incarcare 10 ore / timp de functionare 8 ore				
00-992	5-05	negru - 3 LED lumina alba calda	12	

stalp - aplica rotunda cu 3 LED (2 baterii de 1.5V 1500mAh) timp de incarcare 10 ore / timp de functionare 8 ore				
00-993	5-09	negru - 3 LED lumina alba calda	12	

stalp INOX rotund cu 3 LED (2 baterii de 1.2V 1500mAh) timp de incarcare 10 ore / timp de functionare 8 ore				
00-994	5-016	INOX - 3 LED lumina alba	12	

stalp INOX tip felinar cu 3 LED (2 baterii de 1.5V 1500mAh) timp de incarcare 10 ore / timp de functionare 8 ore				
00-995	5-019	INOX - 3 LED lumina alba	12	

stalp INOX rotund cu 4 LED (3 baterii de 1.5V 1500mAh) timp de incarcare 10 ore / timp de functionare 8 ore				
00-996	5-013	INOX - 4 LED lumina alba	6	

stalp glob D:100mm cu 4 LED RGB (2 baterii de 1.5V 1500mAh) - IP68 timp de incarcare 10 ore / timp de functionare 10 ore				
00-997	5-04	glob - 4 LED lumina RGB	12	



COD DABLEROM	COD PRODUCATOR	DENUMIRE	PAC.	PRET €
glob laptos cu soclu (dulie E27)				
37-001	37001L	laptos Ø20 - E27	4	
37-003	37003L	laptos Ø25 - E27	5	
37-005	37005L	laptos Ø30 - E27	5	
37-007	37007L	laptos Ø40 - E27	1	



glob transparent cu soclu (dulie E27)				
37-000/T	37000T	transparent Ø20 - E27	4	
37-002/T	37002T	transparent Ø25 - E27	5	
37-004/T	37004T	transparent Ø30 - E27	5	
37-006/T	37006T	transparent Ø40 - E27	1	



glob transparent cu soclu (dulie E27)				
37-000/F	37000F	fumuriu Ø20 - E27	4	
37-002/F	37002F	fumuriu Ø25 - E27	5	
37-004/F	37004F	fumuriu Ø30 - E27	5	
37-006/F	37006F	fumuriu Ø40 - E27	1	



COD DABLEROM	COD PRODUCATOR	DENUMIRE	PAC.	PRET €
soclu din bachelita cu dulie E27				
00-880	00880	alb - pozitie dreapta	20	
00-881	00881	alb - pozitie oblica	20	



glob din plastic antivandal pentru 00-880 & 00-881				
00-885	00885	laptos	50/1	



COD DABLEROM	COD PRODUCATOR	DENUMIRE	PAC.	PRET €
aplica pentru tablou (XFWL43) cu transformator pentru becuri JC 2x50W 12V				
00-195/KG	3-02509	auriu	8/1	



COD DABLEROM	COD PRODUCATOR	DENUMIRE	PAC.	PRET €
aplica - spot aluminiu (9242) cu 1 power LED 1W 45° 230V				
00-198/cald	3-924200	satinat - lumina alba calda	12/1	
00-198/rece	3-92420	satinat - lumina alba rece	12/1	



aplica - portativ aluminiu cu dulie E27 max60W				
00-192	0-2006	chrom	10/1	



corp de iluminat "cuier" din aluminiu cu tub T5 (4200k) - culoare:argintiu				
19-027	3-40846	8W L:580mm W:135mm h:85mm	12/1	



corp de iluminat cu leduri si intrerupator interconectabil - culoare:alb				
W:35mm h:35mm				
19-000/cald	3-46500	65LED 3.6W L:320mm lumina alba calda	50/1	
19-000/rece	3-4650	65LED 3.6W L:320mm lumina alba rece	50/1	
19-001/cald	3-412100	121LED 6.8W L:540mm lumina alba calda	25/1	
19-001/rece	3-41210	121LED 6.8W L:540mm lumina alba rece	25/1	

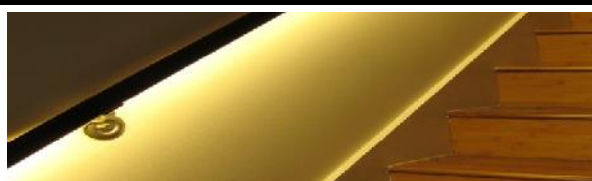

COD DABLEROM	COD PRODUCATOR	DENUMIRE	PAC.	PRET €
corp de iluminat cu tub T5(6400k) si intrerupator interconectabil - culoare:alb				
19-010	3-4061	6W L:270mm W:22mm h:44mm	30/1	
19-011	3-4081	8W L:345mm W:22mm h:44mm	50/1	
19-012	3-4131	13W L:570mm W:22mm h:44mm	30/1	
19-013	3-4211	21W L:910mm W:22mm h:44mm	20/1	
19-014	3-4281	28W L:1210mm W:22mm h:44mm	20/1	



corp de iluminat cu tub T5(6400k) si intrerupator interconectabil - culoare:argintiu				
19-015	3-40816	8W L:345mm W:22mm h:44mm	50/1	
19-016	3-41316	13W L:570mm W:22mm h:44mm	30/1	
19-017	3-42116	21W L:910mm W:22mm h:44mm	20/1	

corp de iluminat "plat" cu tub T5(4200k) si intrerupator interconectabil - culoare:alb				
19-020	3-4082	8W L:340mm W:70mm h:20mm	20/1	
19-021	3-4132	13W L:560mm W:70mm h:20mm	20/1	



corp de iluminat "plat" cu tub T5(4200k) si intrerupator interconectabil - culoare:argintiu				
19-022	3-40826	8W L:340mm W:70mm h:20mm	20/1	
19-023	3-41326	13W L:560mm W:70mm h:20mm	20/1	

corp de iluminat cu tub T5(4200k) , intrerupator si priza suko - culoare:argintiu				
19-009/8	3-408169	8W L:449mm W:87mm h:49mm	20/1	
19-009/13	3-413169	13W L:667mm W:87mm h:49mm	20/1	
19-009/21	3-421169	21W L:1007mm W:87mm h:49mm	12/1	



corp de iluminat mobil din aluminiu cu tub T5 (6400k) - culoare:argintiu				
19-028	3-40836	8W L:350mm W:84mm h:28mm	12/1	
19-029	3-41336	13W L:580mm W:84mm h:28mm	12/1	
19-030	3-42136	21W L:910mm W:84mm h:28mm	12/1	
19-031	3-42836	28W L:1210mm W:84mm h:28mm	12/1	



CORPURI DE ILUMINAT

48

COD DABLEROM	COD PRODUCATOR	DENUMIRE	PAC.	PRET €
corp de iluminat aluminiu cu dulie E27				
XF8				
00-183	3-010806	max 60W - D:80mm h:285mm	20/1	



corp de iluminat aluminiu cu dulie E27				
XF15B				
00-184	3-011306	max 75W - D:135mm h:300mm	9/1	



corp de iluminat aluminiu cu dulie E27				
XF23A				
00-185	3-011656	max 75W - D:165mm h:210mm	3/1	



corp de iluminat aluminiu cu dulie E27				
XF26				
00-187	3-012606	max 75W - D:260mm h:160mm	20/1	



corp de iluminat aluminiu cu dulie E27				
XF37				
00-188	3-013706	max 75W - D:370mm h:240mm	10/1	



corp de iluminat aluminiu cu dulie E27				
XF43				
00-190	3-014506	max 75W - D:450mm h:200mm	20/1	



corp de iluminat aluminiu cu dulie E27				
XF45A				
00-191	3-0145006	max 75W - D:450mm h:190mm	10/1	



CORPURI DE ILUMINAT - ACCESORII

COD DABLEROM	COD PRODUCATOR	DENUMIRE	PAC.	PRET €
farfurie din aluminiu cu fixare pe dulie				
55-150	2-523	∅:23mm	1	
55-151	2-533	∅:33mm	1	



februarie 2012

CORPURI DE ILUMINAT - EMERGENȚA CU LEDURI

49

COD DABLEROM	COD PRODUCATOR	DENUMIRE	PAC.	PREȚ €
corp de iluminat emergenta cu 30 LED - bateria:Ni-MH 3.6V (3x1.2V 1500mA) L:235mm W:65mm h:45mm				
19-915/N	4-68024	20LED autonomia 8 ore	12	
		30LED autonomia 6 ore		

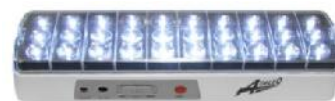

COD DABLEROM	COD PRODUCATOR	DENUMIRE	PAC.	PREȚ €
corp de iluminat emergenta cu 60 LED - bateria:Ni-MH 3.6V (6x1.2V 1500mA) L:550mm W:65mm h:45mm				
19-916/N	4-68020	40LED autonomia 12 ore	10	
		60LED autonomia 10 ore		



COD DABLEROM	COD PRODUCATOR	DENUMIRE	PAC.	PREȚ €
corp de iluminat emergenta mobil cu 60 LED - bateria:Ni-MH 3.6V (6x1.2V 1500mA) L:470mm W:70mm h:58mm				
19-9162/N	4-68029	40LED autonomia 12 ore	8	
		60LED autonomia 10 ore		



CORPURI DE ILUMINAT - EMERGENȚA CU TUB

COD DABLEROM	COD PRODUCATOR	DENUMIRE	PAC.	PREȚ €
corp de iluminat emergenta 1x8W - bateria:Ni-CD 2.4V 4Ah - IP65 L:370mm W:120mm h:85mm				
19-900	4-618502	autonomia 6 ore	12	



COD DABLEROM	COD PRODUCATOR	DENUMIRE	PAC.	PREȚ €
corp de iluminat emergenta 2x20W - bateria:Pb 6V 4Ah L:695mm W:77mm h:105mm				
19-904	4-622000	1 tub autonomia 3 ore	6	
		2 tuburi autonomia 1.5 ore		



BATERII

COD DABLEROM	COD PRODUCATOR	DENUMIRE	PAC.	PREȚ €
baterii pentru corpuri de emergenta				
19-907	4-60002	Pb 6V 1.3Ah	1	
19-909	4-60000	Pb 6V 4Ah	1	
19-911	4-60001	Ni-MH 3.6V 4000mA	1	



februarie 2012

COD DABLEROM	COD PRODUCATOR	DENUMIRE	PAC.	PRET €
corp de iluminat fluorescent T8 - balast electronic - IP65 baza ABS - dispersor acrilic - clipsuri policarbonat				
19-210	3-81183	1x18W L:660mm W:86mm h:90mm	10	
19-213	3-82183	2x18W L:660mm W:136mm h:90mm	8	
19-211	3-81363	1x36W L:1270mm W:86mm h:90mm	6	
19-214	3-82363	2x36W L:1270mm W:136mm h:90mm	4	
19-212	3-81583	1x58W L:1570mm W:86mm h:90mm	6	
19-215	3-82583	2x58W L:1570mm W:136mm h:90mm	4	



corp de iluminat fluorescent T8 - balast electromagnetice - IP65 baza policarbonat - dispersor policarbonat - clipsuri metalice inoxidabile - oglinda in interior				
19-200	3-81181	1x18W L:660mm W:86mm h:90mm	10	
19-203	3-82181	2x18W L:660mm W:136mm h:90mm	8	
19-201	3-81361	1x36W L:1270mm W:86mm h:90mm	6	
19-204	3-82361	2x36W L:1270mm W:136mm h:90mm	4	
19-202	3-81581	1x58W L:1570mm W:86mm h:90mm	6	
19-205	3-82581	2x58W L:1570mm W:136mm h:90mm	4	



corp de iluminat fluorescent T8 - balast electronic - IP65 baza policarbonat - dispersor policarbonat - clipsuri metalice inoxidabile - oglinda in interior				
19-220	3-81182	1x18W L:660mm W:86mm h:90mm	10	
19-223	3-82182	2x18W L:660mm W:136mm h:90mm	8	
19-221	3-81362	1x36W L:1270mm W:86mm h:90mm	6	
19-224	3-82362	2x36W L:1270mm W:136mm h:90mm	4	
19-222	3-81582	1x58W L:1570mm W:86mm h:90mm	6	
19-225	3-82582	2x58W L:1570mm W:136mm h:90mm	4	



corp de iluminat fluorescent T5 - balast electronic - IP65 baza policarbonat - dispersor policarbonat - clipsuri metalice inoxidabile - oglinda in interior				
19-233	3-82245	2x24W L:610mm W:100mm h:75mm	15	
19-231	3-81545	1x54W L:1210mm W:60mm h:75mm	12	
19-234	3-82545	2x54W L:1210mm W:100mm h:75mm	10	
19-232	3-81805	1x80W L:1510mm W:60mm h:75mm	10	
19-235	3-82805	2x80W L:1510mm W:100mm h:75mm	10	



LAMPI PORTABILE

51

COD DABLEROM	COD PRODUCATOR	DENUMIRE	PAC.	PRET €
lampa portabila cu cablu si intrerupator dulie E27 - max 60W - IP20				
00-570/5	4-011225	portocalie - cablu 5m	30	
00-570	4-011220	portocalie - cablu 10m	25	



lampa portabila cu intrerupator si lupa dulie E27 - max 100W - IP20				
00-567	050/13	galbena - fara cablu	12	
00-568	050/12B	galbena - cu cablu 10m	10	



lampa portabila cu 60LED - cu acumulator (autonomie 4 ore) cu incarcator la 220V si 12V(auto) - IP20				
00-498	4-011260	neagra - 60LED lumina alba	20	



lampa portabila cu 60LED - cu acumulator (autonomie 4 ore) cu incarcator la 220V si 12V(auto) - IP20				
00-499	4-0112601	antracit - 60LED lumina alba	10	



LAMPI DE VEGHE

COD DABLEROM	COD PRODUCATOR	DENUMIRE	PAC.	PRET €
lampa de veghe cu bec si intrerupator - (blister) dreapta - PL 1W				
00-581	13-12013	lumina galbena	10	
00-583	13-12015	lumina verde	10	



lampa de veghe cu bec si intrerupator - (blister) inclinata - PL 1W				
00-584	13-12110	lumina alba	10	
00-585	13-12113	lumina galbena	10	
00-586	13-12114	lumina albastru	10	
00-587	13-12115	lumina verde	10	



lampa de veghe cu bec si fotocelula inclinata - 5W				
00-578	13-12210	lumina alba	10	



lampa de veghe cu 5LED si intrerupator - (blister) inclinata - 5LED 0.7W				
00-5771/cald	13-122200	lumina alba calda	10	
00-5771/rece	13-122200	lumina alba rece	10	
00-5771/galben	13-122203	lumina galbena	10	
00-5771/albastru	13-122204	lumina albastru	10	
00-5771/verde	13-122205	lumina verde	10	



lampa de veghe cu 5LED si fotocelula - (blister) inclinata - 5LED 0.7W				
00-577/alb	13-12220	lumina alba	10	
00-577/galben	13-12223	lumina galbena	10	
00-577/albastru	13-12224	lumina albastru	10	
00-577/verde	13-12225	lumina verde	10	



februarie 2012

COD DABLEROM	COD PRODUCATOR	DENUMIRE	PAC.	PRET €
proiector patrat halogen IP54 pentru 2 becuri G5.3 12/24/230V (max 150W)				
00-500/2	4-101	negru	12	

proiector patrat halogen IP54				
00-501	4-150	alb 150W	20	
00-502	4-151	negru 150W	20	
00-503	4-500	alb 500W	12	
00-504	4-501	negru 500W	12	
00-505	4-1000	alb 1000W	6	
00-506	4-1001	negru 1000W	6	

proiector oval halogen IP54				
00-508	4-1503	alb 150W	20	
00-509	4-1513	negru 150W	20	
00-510	4-5003	alb 500W	12	
00-511	4-5013	negru 500W	12	

proiector oval halogen IP54 cu sensor de miscare 180°				
00-516	4-3150	alb 150W	12	
00-517	4-3151	negru 150W	12	
00-518	4-3500	alb 500W	10	
00-519	4-3501	negru 500W	10	

proiectoare / proiector patrat halogen IP54 cu suport (h:1.7m) si cablu 3m				
00-523	4-2503	negru/galben 500W	3	
00-523/2	4-2504	negru/galben 2x500W	3	

proiector patrat halogen IP54 cu suport (clesti) si cablu 1.5m				
00-524	4-2502	galben 150W	8	

proiector patrat halogen IP54 cu suport (baza) si cablu 1.5m				
00-525	4-2501	negru 500W	8	



PROIETTOARE PENTRU BECURI ECONOMICE - IP54

COD DABLEROM	COD PRODUCATOR	DENUMIRE	PAC.	PRET €
proiector CU bec economic 20W - E27 - IP54				
00-597/alb	4-500055	alb 20W	10	
00-597/negru	4-50055	negru 20W	10	



proiector CU bec economic 40W - E27 - IP54				
00-598/alb	4-100055	alb 40W	3	
00-598/negru	4-100155	negru 40W	3	



proiector CU bec economic 65W - E40 - IP54				
00-599/alb	4-1500065	alb 65W	3	
00-599/negru	4-150065	negru 65W	3	



proiector CU bec economic 105W - E40 - IP54				
00-599/105	4-1500105	negru 105W	1	



proiector CU bec economic 120W - E40 - IP54				
00-599/120	4-10025	negru 120W	1	

PROIETTOARE PENTRU BECURI PLC

COD DABLEROM	COD PRODUCATOR	DENUMIRE	PAC.	PRET €
proiector pentru becuri PLC 2x26W - IP54 cu balast electromagnetic				
00-528	4-1520	alb	6	



proiector CU becuri PLC 2x42W - IP54 cu balast electronic				
00-5290	4-15420	alb 2x42W	6	
00-5291	4-15421	negru 2x42W	6	



proiector din POLICARBONAT CU becuri PLC - IP65 cu balast electronic				
00-5302	4-15841	negru 2x42W (4000k)	3/1	
00-5304	4-151681	negru 4x42W (4000k)	2/1	



COD DABLEROM	COD PRODUCATOR	DENUMIRE	PAC.	PRET €
proiector pentru bec HQI - IP65 - simetric				
00-5367	3-000070	alb 70W	4/1	
00-5365/alb	3-000150	alb 150W	4/1	
00-5365/negru	3-000151	negru 150W	4/1	



proiector pentru bec HQI - IP55 - asimetric				
00-5310	3-0070	alb 70W	4/1	
00-5311	3-0071	negru 70W	4/1	
00-5316	3-0076	gri 70W	4/1	
00-533	3-0150	alb 150W	4/1	
00-534	3-0151	negru 150W	4/1	
00-535	3-0156	gri 150W	4/1	



proiector pentru bec HQI - IP55 - simetric				
00-539	3-4250	alb 250W	1	
00-540	3-4251	negru 250W	1	
00-541	3-4256	gri 250W	1	
00-542	3-4400	alb 400W	1	
00-543	3-4401	negru 400W	1	
00-544	3-4406	gri 400W	1	



COD DABLEROM	COD PRODUCATOR	DENUMIRE	PAC.	PRET €
proiector pentru bec HQI - IP65 - asimetric - tip greu				
00-533/2	3-15060	alb 150W	1	
00-534/2	3-15061	negru 150W	1	
00-535/2	3-1506	gri 150W	1	



proiector pentru bec HQI - IP65 - simetric - tip greu				
00-541/2	3-40256	gri 250W	1	
00-542/2	3-40400	alb 400W	1	
00-543/2	3-40401	negru 400W	1	
00-544/2	3-40406	gri 400W	1	



proiector pentru bec HQI - IP65 - asimetric - tip greu				
00-546	3-1006	gri 1000W	1	

CULORI DISPONIBILE:



COD DABLEROM	COD PRODUCATOR	DENUMIRE	PAC.	PRET €
proiector cu 1 POWER LED la 100° - IP65 - 220V - culoare:gri - 10W L:115mm W:105mm h:85mm				
00-50010/cald	3-1010000	1LEDx10W lumina calda (3200k) - 600Lm	1	
00-50010/rece	3-101000	1LEDx10W lumina rece (6500k) - 700Lm	1	
00-50010/verde	3-101005	1LEDx10W lumina verde	1	
00-50010/rgb	3-101009	1LEDx10W lumina RGB	1	



proiector cu 1 POWER LED la 100° - IP65 - 220V - culoare:gri - 20W L:230mm W:200mm h:135mm				
00-50020/cald	3-2010000	1LEDx20W lumina calda (3200k)- 1200Lm	1	
00-50020/rece	3-201000	1LEDx20W lumina rece (6500k) - 1400Lm	1	
00-50020/verde	3-201005	1LEDx20W lumina verde	1	
00-50020/rgb	3-201009	1LEDx20W lumina RGB	1	



proiector cu 1 POWER LED la 100° - IP65 - 220V - culoare:gri - 30W L:230mm W:200mm h:135mm				
00-50030/cald	3-3010000	1LEDx30W lumina calda (3200k)- 1800Lm	1	
00-50030/rece	3-301000	1LEDx30W lumina rece (6500k) - 2100Lm	1	
00-50030/portoc.	3-301003	1LEDx30W lumina portocalie	1	
00-50030/albastru	3-301004	1LEDx30W lumina albastru	1	
00-50030/verde	3-301005	1LEDx30W lumina verde	1	
00-50030/rgb	3-301009	1LEDx30W lumina RGB	1	



proiector cu 1 POWER LED la 100° - IP65 - 220V - culoare:gri - 50W L:285mm W:235mm h:150mm				
00-50050/cald	3-5010000	1LEDx50W lumina calda (3200k)- 2100Lm	1	
00-50050/rece	3-501000	1LEDx50W lumina rece (6500k) - 2400Lm	1	
00-50050/portoc.	3-501003	1LEDx50W lumina portocalie	1	
00-50050/rgb	3-501009	1LEDx50W lumina RGB	1	



proiector cu 1 POWER LED la 100° - IP65 - 220V - culoare:gri - 70W L:320mm W:395mm h:110mm				
00-50070/cald	3-7010000	1LEDx70W lumina calda (3200k)- ...Lm	1	
00-50070/rece	3-701000	1LEDx70W lumina rece (6500k) - ...Lm	1	
00-50070/portoc.	3-701003	1LEDx70W lumina portocalie	1	
00-50070/rgb	3-701009	1LEDx70W lumina RGB	1	



proiector cu 2 POWER LED la 100° - IP65 - 220V - culoare:gri - 100W L:430mm W:390mm h:125mm				
00-50100/cald	3-10010000	2LEDx50W lumina calda (3200k)- 6000Lm	1	
00-50100/rece	3-1001000	2LEDx50W lumina rece (6500k) - 7000Lm	1	
00-50100/portoc.	3-1001003	2LEDx50W lumina portocalie	1	



proiector cu 2 POWER LED la 100° - IP65 - 220V - culoare:gri - 140W L:430mm W:390mm h:125mm				
00-50140/cald	3-14010000	2LEDx70W lumina calda (3200k)- ...Lm	1	
00-50140/rece	3-1401000	2LEDx70W lumina rece (6500k) - ...Lm	1	
00-50140/portoc.	3-1401003	2LEDx70W lumina portocalie	1	

CORPURI DE ILUMINAT - BARA CU POWER LED 220V - IP65

COD DABLEROM	COD PRODUCATOR	DENUMIRE	PAC.	PRET €
proiector - bara din INOX cu 9 POWER LED - IP65 - 220V - culoare:gri - 9W L:50cm				
06-7910/cald	3-7910000	9LED lumina calda (3200k)- 558Lm	1	
06-7910/rece	3-791000	9LED lumina rece (6500k) - 675Lm	1	
06-7910/portoc.	3-791003	9LED lumina portocalie	1	
06-7910/albastru	3-791004	9LED lumina albastru	1	
06-7910/rgb	3-791009	9LED lumina RGB	1	



proiector - bara din INOX cu 24 POWER LED - IP65 - 220V - culoare:gri - 24W L:100cm				
06-7241/cald	3-72410000	24LED lumina calda (3200k)- 1488Lm	1	
06-7241/rece	3-7241000	24LED lumina rece (6500k) - 1800Lm	1	
06-7241/portoc.	3-7241003	24LED lumina portocalie	1	
06-7241/albastru	3-7241004	24LED lumina albastru	1	
06-7241/rgb	3-7241009	24LED lumina RGB	1	

**CORPURI DE ILUMINAT STRADALE CU POWER LED 220V - IP65**

COD DABLEROM	COD PRODUCATOR	DENUMIRE	PAC.	PRET €
corp de iluminat stradal cu POWER LED la 70° - IP65 - 220V - culoare:gri L:520mm W:150mm h:65mm				
55-70201	3-70201	1LEDx20W lumina alba(4000k) - 1400Lm	1	
55-70301	3-70301	1LEDx30W lumina alba(4000k) - 2100Lm	1	



55-70501	3-70501	1LEDx50W lumina alba(4000k) - 3750Lm	1	
55-70701	3-70701	1LEDx70W lumina alba(4000k) - ... Lm	1	



corp de iluminat stradal cu POWER LED la 70° - IP65 - 220V - culoare:gri L:520mm W:150mm h:65mm				
55-70401	3-70401	4LED=40W lumina alba(4000k) - 2800Lm	1	

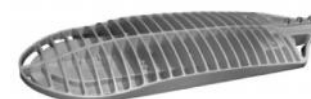

55-70801	3-70801	4LED=80W lumina alba(4000k) - 5600Lm	1	
----------	---------	--------------------------------------	---	--

**CORPURI DE ILUMINAT STRADALE**

COD DABLEROM	COD PRODUCATOR	DENUMIRE	PAC.	PRET €
corp de iluminat stradal din metal/policarbonat/aluminiu				
55-000	DF160	160W autoaprindere - dulie E27	1	36
55-001	DF250	250W autoaprindere - dulie E40	1	48
55-002	DY080	80W mercur - dulie E27	1	40
55-003	DY125	125W mercur - dulie E27	1	42
55-004	DY250	250W mercur - dulie E40	1	66
55-005	DY400	400W mercur - dulie E40	1	120
55-006	DN070	80W sodiu - dulie E27	1	42
55-007	DN150	150W sodiu - dulie E27	1	48
55-008	DN250	250W sodiu - dulie E40	1	83
55-009	DN400	400W sodiu - dulie E40	1	145



CORPURI DE ILUMINAT "VARF"

57

COD DABLEROM	COD PRODUCATOR	DENUMIRE	PAC.	PRET €
corp de iluminat "varf" din metal/plastic/aluminiu				
55-118	KF160	160W autoaprinde - dulia E27	1	
55-119	KF250	250W autoaprinde - dulia E40	1	
55-120	KY080	80W mercur - dulia E27	1	
55-121	KY125	125W mercur - dulia E27	1	
55-122	KY250	250W mercur - dulia E40	1	
55-123	KN070	80W sodiu - dulia E27	1	
55-124	KN150	150W sodiu - dulia E27	1	
55-125	KN250	250W sodiu - dulia E40	1	

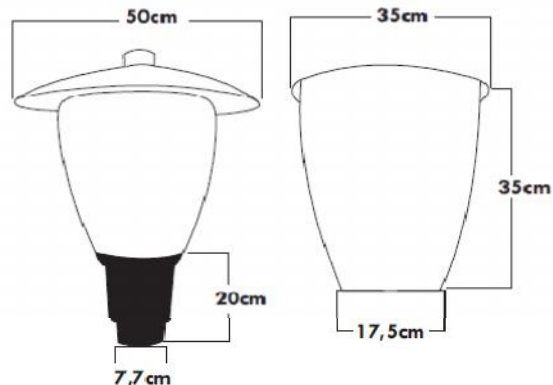

CORPURI DE ILUMINAT "CLOPOT"

COD DABLEROM	COD PRODUCATOR	DENUMIRE	PAC.	PRET €
corp de iluminat "clopot" din aluminiu/metal				
55-010	KA160	160W autoaprinde - dulia E27	1	
55-011	KA250	250W autoaprinde - dulia E40	1	
55-012	KD125	125W mercur - dulia E27	1	
55-013	KD250	250W mercur - dulia E40	1	
55-014	KD400	400W mercur - dulia E40	1	
55-015	KE150	150W sodiu - dulia E27	1	
55-016	KE250	250W sodiu - dulia E40	1	
55-017	KE400	400W sodiu - dulia E40	1	

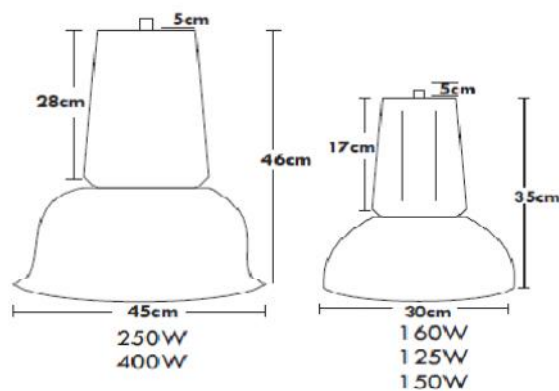

februarie 2012

CORPURI DE ILUMINAT & ACCESORII KALFEX - SOLINA



COD DABLEROM	COD PRODUCATOR	DENUMIRE	PAC.	PRET €
corp de iluminat SOLINA pentru tub T8 - IP20 - 230V culori: alb/negru/rosu/galben/gri/verde/albastru				
45-900/18	90018	1x18W - 60x1108mm	2	
45-900/23	90023	1x23W - 60x1458mm	2	
45-900/36	90036	1x36W - 60x1677mm	2	
45-900/58	90058	1x58W - 60x1963mm	2	



grilaj din PMMA pentru corp SOLINA necesita : 18W/2buc , 23W/3buc , 36W/4buc , 58W/5buc				
45-906/T	906	transparent	4/1	
45-911/L	911	laptos	4/1	



capac terminal din ABS pentru corp SOLINA				
45-902/W	902W	alb	2/1	
45-902/B	902B	negru	2/1	



imbinare liniara din ABS pentru corp SOLINA				
45-909/W	909W	alb	2/1	
45-909/B	909B	negru	2/1	



imbinare fixa 90° din ABS pentru corp SOLINA				
45-901/W	901W	alb	2/1	
45-901/B	901B	negru	2/1	



imbinare flexibila din ABS pentru corp SOLINA				
45-903/W	903W	alb	2/1	
45-903/B	903B	negru	2/1	



imbinare din ABS pentru corp SOLINA				
45-905/W	905W	alb - T	2/1	
45-905/B	905B	negru - T	2/1	
45-908/W	908W	alb - cruce (+)	2/1	
45-908/B	908B	negru - cruce (+)	2/1	
45-910/W	910W	alb - la 90° cu terminatie	2/1	
45-910/B	910B	negru - la 90° cu terminatie	2/1	



set suspendare (posibilitate de reglare) pentru corp SOLINA				
45-907	9071	cu cablu de 1m	2/1	
45-9072	9072	cu cablu de 2m	2/1	
45-9073	9073	cu cablu de 3m	2/1	



set prindere pentru corp SOLINA				
45-1039	1039	set prindere	2/1	



CORPURI DE ILUMINAT & ACCESORII KALFEX - OMEGA

59



COD DABLEROM	COD PRODUCATOR	DENUMIRE	PAC.	PRET €
corp de iluminat OMEGA pentru tub T8 - IP20 - 230V				
culori: alb/negru/rosu/galben/gri/verde/albastru - aluminiu				
45-3000/18	300018	1x18W - 170x47x1100mm - culori	2	
45-3000/36	300036	1x36W - 170x47x1700mm - culori	2	
45-3000/58	300058	1x58W - 170x47x2000mm - culori	2	
45-3000/18/A	300018A	1x18W - 170x47x1100mm - aluminiu	2	
45-3000/36/A	300036A	1x36W - 170x47x1700mm - aluminiu	2	
45-3000/58/A	300058A	1x58W - 170x47x2000mm - aluminiu	2	



grilaj pentru corp OMEGA				
necesita : 18W/2buc , 36W/4buc , 58W/5buc				
45-3003/T	3003	transparent	4/1	
45-3002/L	3002	laptos	4/1	
45-3015/A	3015	aluminiu	4/1	



capac terminal pentru corp OMEGA				
45-3001/W	3001W	alb	2/1	
45-3001/B	3001B	negru	2/1	
45-3001/A	3001A	aluminiu	2/1	



imbinare liniara pentru corp OMEGA				
45-3004/W	3004W	alb	2/1	
45-3004/B	3004B	negru	2/1	
45-3004/A	3004A	aluminiu	2/1	



imbinare pentru corp OMEGA				
45-3009/W	3009W	alb - 90°	2/1	
45-3009/B	3009B	negru - 90°	2/1	
45-3009/A	3009A	aluminiu - 90°	2/1	
45-3007/W	3007W	alb - T	2/1	
45-3007/B	3007B	negru - T	2/1	
45-3007/A	3007A	aluminiu - T	2/1	
45-3008/W	3008W	alb - cruce (+)	2/1	
45-3008/B	3008B	negru - cruce (+)	2/1	
45-3008/A	3008A	aluminiu - cruce (+)	2/1	
45-3011/W	3011W	alb - pentru 5 corpuri	2/1	
45-3011/B	3011B	negru - pentru 5 corpuri	2/1	
45-3011/A	3011A	aluminiu - pentru 5 corpuri	2/1	
45-3012/W	3012W	alb - pentru 6 corpuri	2/1	
45-3012/B	3012B	negru - pentru 6 corpuri	2/1	
45-3012/A	3012A	aluminiu - pentru 6 corpuri	2/1	



set suspendare/prindere pentru corp OMEGA				
45-1040/W	1040W	set suspendare cu cablu de 1m - alb	2/1	
45-1040/B	1040B	set suspendare cu cablu de 1m - negru	2/1	
45-1040/A	1040A	set suspendare cu cablu de 1m - aluminiu	2/1	
45-1039	1039	set prindere	2/1	



februarie 2012

CORPURI DE ILUMINAT & ACCESORII KALFEX - OVAL



COD DABLEROM	COD PRODUCATOR	DENUMIRE	PAC.	PRET €
corp de iluminat OVAL pentru tub T8 - IP20 - 230V				
culori: alb/negru/rosu/galben/gri/verde/albastru - aluminiu				
45-4000/18	400018	2x18W - 170x60x1100mm - culori	2	
45-4000/36	400036	2x36W - 170x60x1700mm - culori	2	
45-4000/58	400058	2x58W - 170x60x2000mm - culori	2	
45-4000/18/A	400018A	2x18W - 170x60x1100mm - aluminiu	2	
45-4000/36/A	400036A	2x36W - 170x60x1700mm - aluminiu	2	
45-4000/58/A	400058A	2x58W - 170x60x2000mm - aluminiu	2	

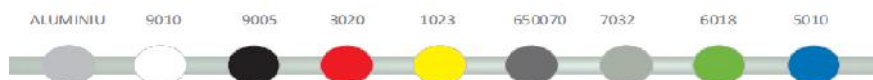

grilaj pentru corp OVAL				
necesita : 18W/2buc , 36W/4buc , 58W/5buc				
45-4003/T	4003	transparent	4/1	
45-4002/L	4002	laptos	4/1	
45-4015/A	4015	aluminiu	4/1	



capac terminal pentru corp OVAL				
45-4001/W	4001W	alb	2/1	
45-4001/B	4001B	negru	2/1	
45-4001/A	4001A	aluminiu	2/1	



imbinare liniara pentru corp OVAL				
45-4004/W	4004W	alb	2/1	
45-4004/B	4004B	negru	2/1	
45-4004/A	4004A	aluminiu	2/1	

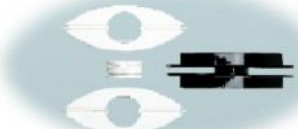

imbinare pentru corp OVAL				
45-4009/W	4009W	alb - 90°	2/1	
45-4009/B	4009B	negru - 90°	2/1	
45-4009/A	4009A	aluminiu - 90°	2/1	
45-4007/W	4007W	alb - T	2/1	
45-4007/B	4007B	negru - T	2/1	
45-4007/A	4007A	aluminiu - T	2/1	
45-4008/W	4008W	alb - cruce (+)	2/1	
45-4008/B	4008B	negru - cruce (+)	2/1	
45-4008/A	4008A	aluminiu - cruce (+)	2/1	
45-4011/W	4011W	alb - pentru 5 corpuri	2/1	
45-4011/B	4011B	negru - pentru 5 corpuri	2/1	
45-4011/A	4011A	aluminiu - pentru 5 corpuri	2/1	



set suspendare/prindere pentru corp OVAL				
45-1040/W	1040W	set suspendare cu cablu de 1m - alb	2/1	
45-1040/B	1040B	set suspendare cu cablu de 1m - negru	2/1	
45-1040/A	1040A	set suspendare cu cablu de 1m - aluminiu	2/1	
45-1039	1039	set prindere	2/1	



CORPURI DE ILUMINAT & ACCESORII KALFEX - MICRO

kalfex
LIGHTING

61

COD DABLEROM	COD PRODUCATOR	DENUMIRE	PAC.	PRET €
corp de iluminat MICRO pentru tub T8 - IP20 - 230V cu dispersor si capac terminal				
45-1200/18	120018	2x18W - 615x57x140mm	2	
45-1200/36	120036	2x36W - 1225x57x140mm	2	
45-1200/58	120058	2x58W - 1525x57x140mm	2	

MICRO 12000



set suspendare (posibilitate de reglare) pentru corp MICRO				
45-12011	12011	cu cablu de 1m	2/1	



CORPURI DE ILUMINAT & ACCESORII KALFEX - KIMA

kalfex
LIGHTING

COD DABLEROM	COD PRODUCATOR	DENUMIRE	PAC.	PRET €
corp de iluminat KIMA cu tub T5 - IP20 - 230V - complet echipat culori: alb/negru - aluminiu				
45-8214	8214	2x14W - 590X265mm - culori	2	
45-8214/A	8214A	2x14W - 590X265mm - aluminiu	2	
45-8221	8221	2x21W - 900X265mm - culori	2	
45-8221/A	8221A	2x21W - 900X265mm - aluminiu	2	
45-8228	8228	2x28W - 1200X265mm - culori	2	
45-8228/A	8228A	2x28W - 1200X265mm - aluminiu	2	
45-8328	8328	3x28W - 1200X380mm - culori	2	
45-8328/A	8328A	3x28W - 1200X380mm - aluminiu	2	
45-8235	8235	2x35W - 1500X265mm - culori	2	
45-8235/A	8235A	2x35W - 1500X265mm - aluminiu	2	
45-8335	8335	3x35W - 1500X380mm - culori	2	
45-8335/A	8335A	3x35W - 1500X380mm - aluminiu	2	



KIMA 8000



ALB ALUMINIU



februarie 2012

CORPURI DE ILUMINAT & ACCESORII KALFEX - AVANT

62



COD DABLEROM	COD PRODUCATOR	DENUMIRE	PAC.	PRET €
corp de iluminat AVANT pentru tub T8 - IP20 - 230V				
culori: alb/negru - aluminiu				
45-14218	14218	2x18W - 175x40x744mm - culori	2	
45-14236	14236	2x36W - 175x40x1353mm - culori	2	
45-14258	14258	2x58W - 175x40x1657mm - culori	2	
45-14218/A	14218A	2x18W - 175x40x744mm - aluminiu	2	
45-14236/A	14236A	2x36W - 175x40x1353mm - aluminiu	2	
45-14258/A	14258A	2x58W - 175x40x1657mm - aluminiu	2	



corp de iluminat AVANT cu tub T5 - IP20 - 230V				
culori: alb/negru - aluminiu				
45-14214	14214	2x14W - 175x40x694mm - culori	2	
45-14224	14224	2x24W - 175x40x694mm - culori	2	
45-14228	14228	2x28W - 175x40x1303mm - culori	2	
45-14254	14254	2x54W - 175x40x1303mm - culori	2	
45-14235	14235	2x35W - 175x40x1607mm - culori	2	
45-14280	14280	2x80W - 175x40x1607mm - culori	2	
45-14214/A	14214A	2x14W - 175x40x694mm - aluminiu	2	
45-14224/A	14224A	2x24W - 175x40x694mm - aluminiu	2	
45-14228/A	14228A	2x28W - 175x40x1303mm - aluminiu	2	
45-14254/A	14254A	2x54W - 175x40x1303mm - aluminiu	2	
45-14235/A	14235A	2x35W - 175x40x1607mm - aluminiu	2	
45-14280/A	14280A	2x80W - 175x40x1607mm - aluminiu	2	

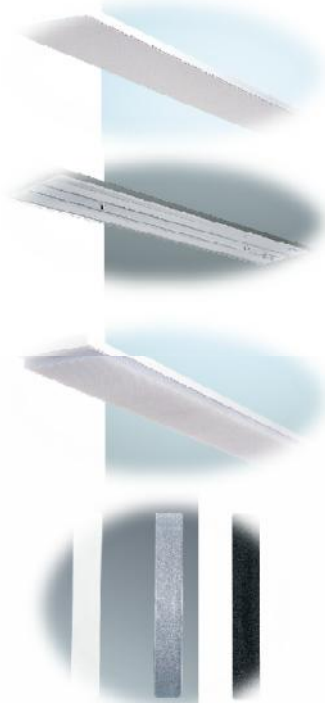

capac terminal pentru corp AVANT				
45-14001/W	14001W	alb	2/1	
45-14001/B	14001B	negru	2/1	
45-14001/A	14001A	aluminiu	2/1	

imbinare liniara pentru corp AVANT				
45-14004	14004	universala pentru toate AVANT	2/1	

imbinare pentru corp AVANT				
45-14009/W	14009W	alb - 90°	2/1	
45-14009/B	14009B	negru - 90°	2/1	
45-14009/A	14009A	aluminiu - 90°	2/1	
45-14007/W	14007W	alb - T	2/1	
45-14007/B	14007B	negru - T	2/1	
45-14007/A	14007A	aluminiu - T	2/1	
45-14008/W	14008W	alb - cruce (+)	2/1	
45-14008/B	14008B	negru - cruce (+)	2/1	
45-14008/A	14008A	aluminiu - cruce (+)	2/1	

set suspendare/prindere pentru corp AVANT				
45-14011/W	14011W	set suspendare cu cablu de 1m - alb	2/1	
45-14011/B	14011B	set suspendare cu cablu de 1m - negru	2/1	
45-14011/A	14011A	set suspendare cu cablu de 1m - aluminiu	2/1	
45-14018	14018	set prindere	2/1	



februarie 2012

ACCESORII KALFEX - AVANT



COD DABLEROM	COD PRODUCATOR	DENUMIRE	PAC.	PRET €
SET grilaj transparent pentru corp de iluminat AVANT				
fiecare corp necesita un SET				
45-1403218/L	1400318	pentru corp 2x18W	2	
45-1400336/L	1400336	pentru corp 2x36W	2	
45-1400358/L	1400358	pentru corp 2x58W	2	
45-1400314/L	1400314	pentru corp 2x14W	2	
45-1400324/L	1400324	pentru corp 2x24W	2	
45-1400328/L	1400328	pentru corp 2x28W	2	
45-1400358/L	1400358	pentru corp 2x54W	2	
45-1400335/L	1400335	pentru corp 2x35W	2	
45-1400380/L	1400380	pentru corp 2x80W	2	

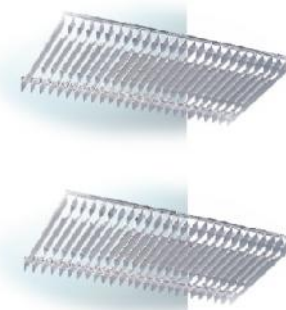

SET grilaj laptos pentru corp de iluminat AVANT				
fiecare corp necesita un SET				
45-1400218/L	1400218	pentru corp 2x18W	2	
45-1400236/L	1400236	pentru corp 2x36W	2	
45-1400258/L	1400258	pentru corp 2x58W	2	
45-1400214/L	1400214	pentru corp 2x14W	2	
45-1400224/L	1400224	pentru corp 2x24W	2	
45-1400228/L	1400228	pentru corp 2x28W	2	
45-1400258/L	1400258	pentru corp 2x54W	2	
45-1400235/L	1400235	pentru corp 2x35W	2	
45-1400280/L	1400280	pentru corp 2x80W	2	

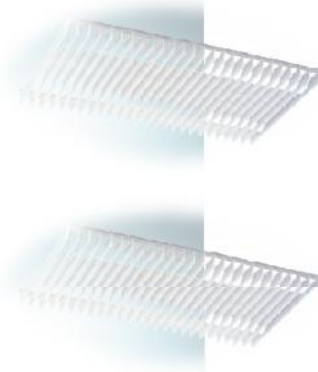

capac frontal transparent pentru corp de iluminat AVANT numai cu tub T5				
fiecare corp necesita un capac				
45-1401314	1401314	pentru corp 2x14W	2	
45-1401324	1401324	pentru corp 2x24W	2	
45-1401328	1401328	pentru corp 2x28W	2	
45-1401354	1401354	pentru corp 2x54W	2	
45-1401335	1401335	pentru corp 2x35W	2	
45-1401380	1401380	pentru corp 2x80W	2	



reflector aluminiu dublu parabolic pentru corp de iluminat AVANT numai cu tub T5				
fiecare corp necesita un capac				
45-1401514	1401514	pentru corp 2x14W	2	
45-1401524	1401524	pentru corp 2x24W	2	
45-1401528	1401528	pentru corp 2x28W	2	
45-1401554	1401554	pentru corp 2x54W	2	
45-1401535	1401535	pentru corp 2x35W	2	
45-1401580	1401580	pentru corp 2x80W	2	





COD DABLEROM	COD PRODUCATOR	DENUMIRE	PAC.	PRET €
corp de iluminat SFERA cu tub T5 - IP20 - 230V				
45-20214	20214	2x14W - 120x130x690mm	2	
45-20224	20224	2x24W - 120x130x690mm	2	
45-20239	20239	2x39W - 120x130x990mm	2	
45-20228	20228	2x28W - 120x130x1290mm	2	
45-20254	20254	2x54W - 120x130x1290mm	2	
45-20235	20235	2x35W - 120x130x1590mm	2	
45-20280	20280	2x80W - 120x130x1590mm	2	



SFERA 20000



capac terminal pentru corp SFERA				
45-20001	20001	aluminiu	2/1	



imbinare liniara pentru corp SFERA				
45-20004	20004	aluminiu	2/1	



cot pentru corp SFERA				
45-20009	20009	aluminiu - 90°	2/1	



set suspendare/prindere pentru corp SFERA				
45-20011	20011	set suspendare cu cablu de 1m - alb	2/1	
45-20011A	20011A	set suspendare cu cablu de 1m - aluminiu	2/1	
45-20011-2	20011-2	set suspendare cu cablu de 2m - alb	2/1	
45-20011A-2	20011A-2	set suspendare cu cablu de 2m - aluminiu	2/1	
45-20011-3	20011-3	set suspendare cu cablu de 3m - alb	2/1	
45-20011A-3	20011A-3	set suspendare cu cablu de 3m - aluminiu	2/1	
45-20018	20018	set prindere	2/1	
45-20012	20012	set dija (30cm)	2/1	



aplica SFERA cu tub T5 - IP20 - 230V				
45-2020214	2020214	2x14W - 120x130x690mm	2	
45-2020224	2020224	2x24W - 120x130x690mm	2	
45-2020239	2020239	2x39W - 120x130x990mm	2	
45-2020228	2020228	2x28W - 120x130x1290mm	2	
45-2020254	2020254	2x54W - 120x130x1290mm	2	
45-2020235	2020235	2x35W - 120x130x1590mm	2	
45-2020280	2020280	2x80W - 120x130x1590mm	2	



COD DABLEROM	COD PRODUCATOR	DENUMIRE	PAC.	PRET €
corp de iluminat KYBOS cu tub T5 - IP20 - 230V				
45-25214	25214	2x14W - 120x130x690mm	2	
45-25224	25224	2x24W - 120x130x690mm	2	
45-25239	25239	2x39W - 120x130x990mm	2	
45-25228	25228	2x28W - 120x130x1290mm	2	
45-25254	25254	2x54W - 120x130x1290mm	2	
45-25235	25235	2x35W - 120x130x1590mm	2	
45-25249	25249	2x49W - 120x130x1590mm	2	
45-25280	25280	2x80W - 120x130x1590mm	2	



capac terminal pentru corp KYBOS				
45-25001	25001	aluminiu	2/1	

imbinare liniara pentru corp KYBOS				
45-25004	25004	aluminiu	2/1	

cot pentru corp KYBOS				
45-25009	25009	aluminiu - 90°	2/1	

set suspendare/prindere pentru corp KYBOS				
45-25011	25011	set suspendare cu cablu de 1m - alb	2/1	
45-25011A	25011A	set suspendare cu cablu de 1m - aluminiu	2/1	
45-25011-2	25011-2	set suspendare cu cablu de 2m - alb	2/1	
45-25011A-2	25011A-2	set suspendare cu cablu de 2m - aluminiu	2/1	
45-25011-3	25011-3	set suspendare cu cablu de 3m - alb	2/1	
45-25011A-3	25011A-3	set suspendare cu cablu de 3m - aluminiu	2/1	
45-25018	25018	set prindere	2/1	
45-25012	25012	set dija (30cm)	2/1	



aplica KYBOS cu tub T5 - IP20 - 230V				
45-2525214	2525214	2x14W - 120x130x690mm	2	
45-2525224	2525224	2x24W - 120x130x690mm	2	
45-2525239	2525239	2x39W - 120x130x990mm	2	
45-2525228	2525228	2x28W - 120x130x1290mm	2	
45-2525254	2525254	2x54W - 120x130x1290mm	2	
45-2525235	2525235	2x35W - 120x130x1590mm	2	
45-2525249	2525249	2x49W - 120x130x1590mm	2	
45-2525280	2525280	2x80W - 120x130x1590mm	2	

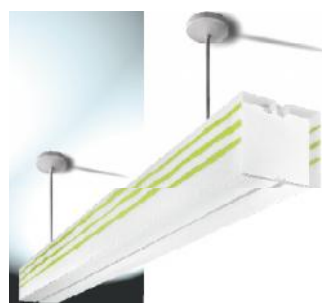

CORPURI DE ILUMINAT & ACCESORII KALFEX - FOS 17000



COD DABLEROM	COD PRODUCATOR	DENUMIRE	PAC.	PRET €
corp de iluminat FOS 17000 cu tub T5 - IP20 - 230V				
45-17114	17114	1x14W - 56X60X578mm	2	
45-17124	17124	1x24W - 56X60X578mm	2	
45-17128	17128	1x28W - 56X60X1178mm	2	
45-17139	17139	1x39W - 56X60X878mm	2	
45-17154	17154	1x54W - 56X60X1178mm	2	
45-17135	17135	1x35W - 56X60X1478mm	2	
45-17180	17180	1x80W - 56X60X1478mm	2	

FOS 17000



capac frontal mat pentru corp de iluminat FOS 17000 fiecare corp necesita un capac

45-1701314	1701314	pentru corp 1x14W	2	
45-1701324	1701324	pentru corp 1x24W	2	
45-1701328	1701328	pentru corp 1x28W	2	
45-1701339	1701339	pentru corp 1x39W	2	
45-1701354	1701354	pentru corp 1x54W	2	
45-1701335	1701335	pentru corp 1x35W	2	
45-1701380	1701380	pentru corp 1x80W	2	

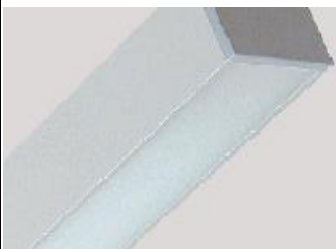

SET grilaj aluminiu pentru corp de iluminat FOS 17000 fiecare corp necesita un SET

45-1701614	1701614	pentru corp 1x14W	2	
45-1701624	1701624	pentru corp 1x24W	2	
45-1701628	1701628	pentru corp 1x28W	2	
45-1701639	1701639	pentru corp 1x39W	2	
45-1701654	1701654	pentru corp 1x54W	2	
45-1701635	1701635	pentru corp 1x35W	2	
45-1701680	1701680	pentru corp 1x80W	2	



reflector aluminiu dublu parabolic pentru corp de iluminat FOS 17000 fiecare corp necesita un capac

45-1701514	1701514	pentru corp 1x14W	2	
45-1701524	1701524	pentru corp 1x24W	2	
45-1701528	1701528	pentru corp 1x28W	2	
45-1701539	1701539	pentru corp 1x39W	2	
45-1701554	1701554	pentru corp 1x54W	2	
45-1701535	1701535	pentru corp 1x35W	2	
45-1701580	1701580	pentru corp 1x80W	2	



accesorii pentru corp FOS 17000

45-17001	17001	capac terminal	2/1	
45-17001/A	17001A	capac terminal aluminiu	2/1	
45-17004	17004	imbinare liniara universala	2/1	
45-17009	17009	cot la 90°	2/1	
45-17009/A	17009A	cot la 90° aluminiu	2/1	
45-17011	17011	set suspendare cu cablu de 1m	2/1	
45-17011/A	17011/A	set suspendare cu cablu de 1m - aluminiu	2/1	
45-17018	17018	set prindere	2/1	



CORPURI DE ILUMINAT & ACCESORII KALFEX - FOS 18000

67



COD DABLEROM	COD PRODUCATOR	DENUMIRE	PAC.	PRET €
corp de iluminat FOS 18000 cu tub T5 - IP20 - 230V				
45-18214	18214	2x14W - 56X90X578mm	2	
45-18224	18224	2x24W - 56X90X578mm	2	
45-18228	18228	2x28W - 56X90X1178mm	2	
45-18239	18239	2x39W - 56X90X878mm	2	
45-18254	18254	2x54W - 56X90X1178mm	2	
45-18235	18235	2x35W - 56X90X1478mm	2	
45-18280	18280	2x80W - 56X90X1478mm	2	



capac frontal mat pentru corp de iluminat FOS 18000				
fiecare corp necesita un capac				
45-1801314	1801314	pentru corp 2x14W	2	
45-1801324	1801324	pentru corp 2x24W	2	
45-1801328	1801328	pentru corp 2x28W	2	
45-1801339	1801339	pentru corp 2x39W	2	
45-1801354	1801354	pentru corp 2x54W	2	
45-1801335	1801335	pentru corp 2x35W	2	
45-1801380	1801380	pentru corp 2x80W	2	



SET grilaj aluminiu pentru corp de iluminat FOS 18000				
fiecare corp necesita un SET				
45-1801614	1801614	pentru corp 2x14W	2	
45-1801624	1801624	pentru corp 2x24W	2	
45-1801628	1801628	pentru corp 2x28W	2	
45-1801639	1801639	pentru corp 2x39W	2	
45-1801654	1801654	pentru corp 2x54W	2	
45-1801635	1801635	pentru corp 2x35W	2	
45-1801680	1801680	pentru corp 2x80W	2	



reflector aluminiu dublu parabolic pentru corp de iluminat FOS 18000				
fiecare corp necesita un capac				
45-1801514	1801514	pentru corp 2x14W	2	
45-1801524	1801524	pentru corp 2x24W	2	
45-1801528	1801528	pentru corp 2x28W	2	
45-1801539	1801539	pentru corp 2x39W	2	
45-1801554	1801554	pentru corp 2x54W	2	
45-1801535	1801535	pentru corp 2x35W	2	
45-1801580	1801580	pentru corp 2x80W	2	



accesorii pentru corp FOS 18000				
45-18001	18001	capac terminal	2/1	
45-18001/A	18001A	capac terminal aluminiu	2/1	
45-18004	18004	imbinare liniara universala	2/1	
45-18009	18009	cot la 90°	2/1	
45-18009/A	18009A	cot la 90° aluminiu	2/1	
45-18011	18011	set suspendare cu cablu de 1m	2/1	
45-18011/A	18011/A	set suspendare cu cablu de 1m - aluminiu	2/1	
45-18018	18018	set prindere	2/1	

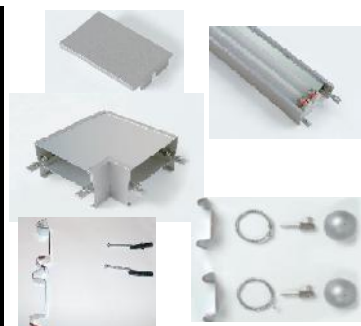

februarie 2012

CORPURI DE ILUMINAT EMERGENTA OLYMPIA-ELECTRONICS

68

olympia-electronics

COD	PUTERE	DENUMIRE	PAC.	PRET €
corpuri de iluminat de siguranta "SLIM LIGHT" IP20 246x76x42mm				
GR-8	6W	nepermanent - 90min.	16/1	
GR-9	6W	nepermanent - 180min.	16/1	
GR-2000	LED / 4W	perm./neperm. (optional) - minim 180min.	10/1	
IRT-200	-	controler pentru GR-2000	2/1	



corpuri de iluminat de siguranta "CLASSIC LIGHT" IP20 260x100x70mm				
GR-108	6W	nepermanent - 90min.	16/1	
GR-105	6W	permanent - 90min.	16/1	
A-1015	-	baza pentru incastrare	2/1	
C-102	-	glij metalic de protectie	2/1	



corpuri de iluminat de siguranta "EASY LIGHT" IP40 350x134x45mm				
GR-310	8W	nepermanent - 90min.	15/1	
GR-310/2	2x8W	nepermanent - 90min.	15/1	
GR-312	8W	nepermanent - 180min.	15/1	
GR-315	8W	permanent - 90min.	15/1	
GR-316	8W	permanent - 180min.	15/1	
A-3016	-	baza pentru incastrare	2/1	
A-3018	-	arcuri pentru tavane suspendate	2/1	
C-101	-	glij metalic de protectie	2/1	
SP-114	-	panou cu marcaj dublu	2/1	



corpuri de iluminat de siguranta "WEATHER LIGHT" IP65 355x160x72mm				
GR-935	8W	nepermanent - 90min.	15/1	
GR-936	8W	nepermanent - 180min.	15/1	
GR-938	8W	permanent - 90min.	15/1	
GR-939	8W	permanent - 180min.	15/1	
C-101	-	glij metalic de protectie	2/1	



corpuri de iluminat de siguranta "ECO LIGHT" IP40 283x130x25mm				
MLD-28S/g/90	12LED / 18lumen	permanent - 90min.	10/1	
MLD-28S/g	12LED / 18lumen	permanent - 180min.	10/1	



convertor cu acumulator				
GR4/UN/A986	-	convertor cu acumulator Ni-Cd 3.6V/1Ah	10/1	
GR-4/UN/65	-	convertor cu acumulator Ni-Cd 3.6V/1,5Ah	10/1	

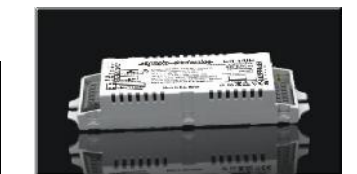

Pentru mai multe informatii si repere ale OLYMPIA ELECTRONICS puteti solicita catalogul complet sau puteti vizita site-ul oficial al producatorului .

www.olympia-electronics.gr

februarie 2012



SISTEME DETECTIE GAZ OLYMPIA-ELECTRONICS



ACCES HOTELIER OLYMPIA-ELECTRONICS



CAPCANE PENTRU INSECTE OLYMPIA-ELECTRONICS



Pentru mai multe informatii si repere ale OLYMPIA ELECTRONICS puteti solicita catalogul complet sau puteti vizita site-ul oficial al producatorului .

www.olympia-electronics.gr

COD DABLEROM	COD PRODUCATOR	DENUMIRE	PAC.	PRET €
banda alba cu autocolant cu 60LED/m (2.5x3mm) - 12VDC - IP20 - 4.8W/m W:6mm h:2.2mm L:5m - posibilitate :taiere min.5cm , :prelungire max.10m				
05-001/cald	30-341000	lumina alba calda - 4Lumen/LED	5	
05-001/rece	30-34100	lumina alba rece - 5Lumen/LED	5	
05-001/rosu	30-34102	lumina rosie	5	
05-001/portocalie	30-34103	lumina portocalie	5	
05-001/albastru	30-34104	lumina albastra	5	
05-001/verde	30-34105	lumina verde	5	
05-008	30-31	conector cu cablu	10	
05-009	30-34	conector fara cablu (mufa)	10	
05-008/2	30-37	conectori cu cablu	10	

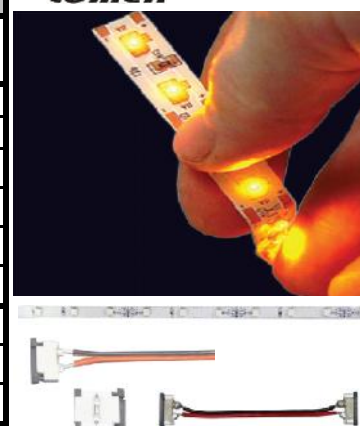

COD DABLEROM	COD PRODUCATOR	DENUMIRE	PAC.	PRET €
banda alba cu autocolant cu 60LED/m (2.5x3mm) - 12VDC - IP54 - 4.8W/m W:8.2mm h:3mm L:5m - posibilitate :taiere min.5cm , :prelungire max.10m				
05-002/cald	30-341100	lumina alba calda - 4Lumen/LED	5	
05-002/rece	30-34110	lumina alba rece - 5Lumen/LED	5	
05-002/rosu	30-34112	lumina rosie	5	
05-002/portocalie	30-34113	lumina portocalie	5	
05-002/albastru	30-34114	lumina albastra	5	
05-002/verde	30-34115	lumina verde	5	
05-008	30-31	conector cu cablu	10	
05-009	30-34	conector fara cablu (mufa)	10	
05-008/2	30-37	conectori cu cablu	10	

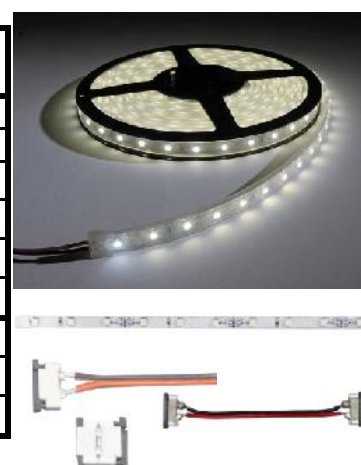

COD DABLEROM	COD PRODUCATOR	DENUMIRE	PAC.	PRET €
banda neagra cu autocolant cu 60LED/m (2.5x3mm) - 12VDC - IP54 - 4.8W/m W:8.2mm h:3mm L:5m - posibilitate :taiere min.5cm , :prelungire max.10m				
05-003/cald	30-3401100	lumina alba calda - 4Lumen/LED	5	
05-003/rece	30-340110	lumina alba rece - 5Lumen/LED	5	
05-003/albastru	30-340114	lumina albastra	5	
05-008	30-31	conector cu cablu	10	
05-009	30-34	conector fara cablu (mufa)	10	
05-008/2	30-37	conectori cu cablu	10	

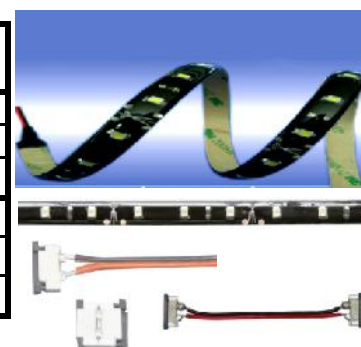

COD DABLEROM	COD PRODUCATOR	DENUMIRE	PAC.	PRET €
banda alba cu autocolant cu 60LED/m (2.5x3mm) - 12VDC - IP67 - 4.8W/m W:10.4mm h:4.5mm L:5m - posibilitate :taiere min.5cm , :prelungire max.10m				
05-004/cald	30-341200	lumina alba calda - 4Lumen/LED	5	
05-004/rece	30-34120	lumina alba rece - 5Lumen/LED	5	
05-004/albastru	30-34124	lumina albastra	5	
05-004/verde	30-34125	lumina verde	5	
05-088	30-32	conector cu cablu	10	
05-089	30-35	conector fara cablu (mufa)	10	
05-088/2	30-38	conectori cu cablu	10	
05-004/00	30-00	sistem de prindere	50	
05-004/01	30-01	capac terminal pentru banda	10	
05-004/02	30-02	capac terminal pentru 05-088	10	

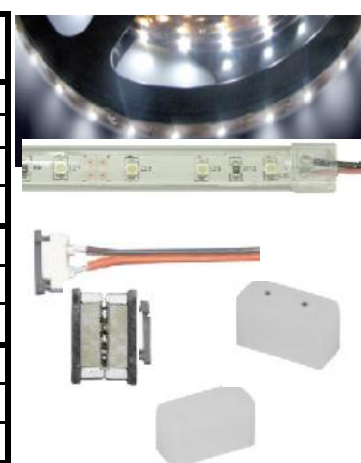



COD DABLEROM	COD PRODUCATOR	DENUMIRE	PAC.	PRET €
banda alba cu autocolant cu 30LED/m (5x5mm) - 12VDC - IP20 - 7.2W/m W:10mm h:2.2mm L:5m - posibilitate :taiere min.10cm , :prelungire max.10m				
05-080/cald	30-342000	lumina alba cald a - 14Lumen/LED	5	
05-080/rece	30-34200	lumina alba rece - 15Lumen/LED	5	
05-080/rosu	30-34202	lumina rosie	5	
05-080/portocalie	30-34203	lumina portocalie	5	
05-080/albastru	30-34204	lumina albastra	5	
05-080/verde	30-34205	lumina verde	5	
05-080/RGB	30-34201	lumina RGB	5	
05-088	30-32	conector cu cablu	10	
05-089	30-35	conector fara cablu (mufa)	10	
05-088/2	30-38	conectori cu cablu	10	
05-088/RGB	30-33	conector cu cablu pentru banda RGB	10	
05-089/RGB	30-36	conector fara cablu (mufa) pentru RGB	10	
05-088/RGB/2	30-39	conectori cu cablu pentru banda RGB	10	

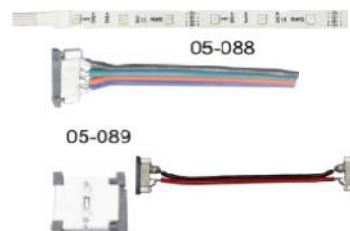

banda alba cu autocolant cu 30LED/m (5x5mm) - 12VDC - IP54 - 7.2W/m W:10mm h:3.2mm L:5m - posibilitate :taiere min.10cm , :prelungire max.10m				
05-081/cald	30-342100	lumina alba cald a - 14Lumen/LED	5	
05-081/rece	30-34210	lumina alba rece - 15Lumen/LED	5	
05-081/rosu	30-34212	lumina rosie	5	
05-081/portocalie	30-34213	lumina portocalie	5	
05-081/albastru	30-34214	lumina albastra	5	
05-081/verde	30-34215	lumina verde	5	
05-081/RGB	30-34211	lumina RGB	5	
05-088	30-32	conector cu cablu	10	
05-089	30-35	conector fara cablu (mufa)	10	
05-088/2	30-38	conectori cu cablu	10	
05-088/RGB	30-33	conector cu cablu pentru banda RGB	10	
05-089/RGB	30-36	conector fara cablu (mufa) pentru RGB	10	
05-088/RGB/2	30-39	conectori cu cablu pentru banda RGB	10	



banda neagra cu autocolant cu 30LED/m (5x5mm) - 12VDC - IP54 - 7.2W/m W:10mm h:3.2mm L:5m - posibilitate :taiere min.10cm , :prelungire max.10m				
05-082/cald	30-3402100	lumina alba cald a - 14Lumen/LED	5	
05-082/rece	30-340210	lumina alba rece - 15Lumen/LED	5	
05-082/albastru	30-340214	lumina albastra	5	
05-082/RGB	30-340211	lumina RGB	5	
05-088	30-32	conector cu cablu	10	
05-089	30-35	conector fara cablu (mufa)	10	
05-088/2	30-38	conectori cu cablu	10	
05-088/RGB	30-33	conector cu cablu pentru banda RGB	10	
05-089/RGB	30-36	conector fara cablu (mufa) pentru RGB	10	
05-088/RGB/2	30-39	conectori cu cablu pentru banda RGB	10	



BENZI CU LED & ACCESORII 12VDC

COD DABLEROM	COD PRODUCATOR	DENUMIRE	PAC.	PRET €
banda alba cu autocolant cu 30LED/m (5x5mm) - 12VDC - IP67 - 7.2W/m W:12mm h:5mm L:5m - posibilitate :taiere min.10cm , :prelungire max.10m				
05-083/cald	30-342200	lumina alba cald a - 14Lumen/LED	5	
05-083/rece	30-34220	lumina alba rece - 15Lumen/LED	5	
05-083/albastru	30-34224	lumina albastru	5	
05-083/RGB	30-34221	lumina RGB	5	
05-090	30-40	conector cu cablu	10	
05-091	30-42	conector fara cablu (mufa)	10	
05-090/2	30-44	conectori cu cablu	10	
05-092/RGB	30-41	conector cu cablu pentru banda RGB	10	
05-093/RGB	30-43	conector fara cablu (mufa) pentru RGB	10	
05-092/RGB/2	30-45	conectori cu cablu pentru banda RGB	10	
05-083/03	30-03	sistem de prindere	25	
05-083/04	30-04	capac terminal pentru banda	10	
05-084/05	30-05	capac terminal pentru 05-090	10	
05-084/06	30-06	capac terminal pentru 05-092/RGB	10	

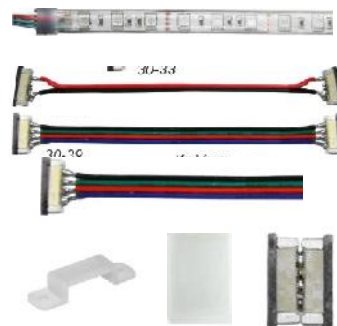
**BENZI CU LED & ACCESORII 220VAC**

COD DABLEROM	COD PRODUCATOR	DENUMIRE	PAC.	PRET €
banda alba cu 60LED/m (5x5mm) - 230VAC - IP67 - 14.4W/m W:12mm h:4.5mm L:10m - posibilitate :taiere min.1m , :prelungire max.50m				
05-000/cald	30-35200	lumina alba cald a - 14Lumen/LED	10	
05-000/rece	30-3520	lumina alba rece - 15Lumen/LED	10	
05-000/albastru	30-3524	lumina albastru	10	
05-000/cab	30-352	cablu de alimentare 230V & capac	50/5	

BENZI CU LED & ACCESORII 24VDC

COD DABLEROM	COD PRODUCATOR	DENUMIRE	PAC.	PRET €
banda alba cu autocolant cu 60LED/m (5x5mm) - 24VDC - IP54 - 14.4W/m W:12mm h:3.2mm L:5m - posibilitate :taiere min.10cm , :prelungire max.10m				
05-084/cald	30-3491100	lumina alba cald a - 14Lumen/LED	5	
05-084/rece	30-349110	lumina alba rece - 15Lumen/LED	5	
05-084/albastru	30-349114	lumina albastru	5	
05-084/RGB	30-349111	lumina RGB	5	
05-090	30-40	conector cu cablu	10	
05-091	30-42	conector fara cablu (mufa)	10	
05-090/2	30-44	conectori cu cablu	10	
05-092/RGB	30-41	conector cu cablu pentru banda RGB	10	
05-093/RGB	30-43	conector fara cablu (mufa) pentru RGB	10	
05-092/RGB/2	30-45	conectori cu cablu pentru banda RGB	10	





BARA MINI DIN ALUMINIU CU LED 12VDC IP65

COD DABLEROM	COD PRODUCATOR	DENUMIRE	PAC.	PRET €
bara mini din aluminiu cu 18LED - 12VDC - IP65 - 1.5W - 120° - L:30cm W:10.5mm h:4mm L:300mm - prelungire max.5m				
05-011/cald	30-3330300	lumina alba cald a - 5.8Lumen/LED	50/1	
05-011/rece	30-333030	lumina alba rece - 6.7Lumen/LED	50/1	

bara mini din aluminiu cu 30LED - 12VDC - IP65 - 2.5W - 120° - L:50cm W:10.5mm h:4mm L:500mm - prelungire max.5m				
05-012/cald	30-3330500	lumina alba cald a - 5.8Lumen/LED	50/1	
05-012/rece	30-333050	lumina alba rece - 6.7Lumen/LED	50/1	

BARA DIN ALUMINIU CU LED & ACCESORII 24VDC IP54

COD DABLEROM	COD PRODUCATOR	DENUMIRE	PAC.	PRET €
bara din aluminiu cu 9LED - 24VDC - IP54 - 3W - 120° - L:20cm W:17mm h:11mm L:200mm - prelungire max.2m				
05-016/cald	30-3342000	lumina alba cald a - 20Lumen/LED	25/1	
05-016/rece	30-334200	lumina alba rece - 25Lumen/LED	25/1	

bara din aluminiu cu 24LED - 24VDC - IP54 - 6W - 120° - L:50cm W:17mm h:11mm L:500mm - prelungire max.2m				
05-017/cald	30-3345000	lumina alba cald a - 20Lumen/LED	25/1	
05-017/rece	30-334500	lumina alba rece - 25Lumen/LED	25/1	

bara din aluminiu cu 48LED - 24VDC - IP54 - 11W - 120° - L:1m W:17mm h:11mm L:1000mm - prelungire max.2m				
05-018/cald	30-334100	lumina alba cald a - 20Lumen/LED	25/1	
05-018/rece	30-33410	lumina alba rece - 25Lumen/LED	25/1	

05-018/traf	30-3362424	transformator pt. bara 24V (max.24W)	1	
05-018/cable	30-3340	cablu de prelungire pt. bara 24V	1	

LANT DIN PLASTIC CU 40LED 12VDC IP44

COD DABLEROM	COD PRODUCATOR	DENUMIRE	PAC.	PRET €
lant din plastic cu 40LED (20bare x 2LED=40LED) - 12VDC - IP44 - 10W/set- L:2m/set bara:W:12mm h:5mm L:45mm - prelungire max.10m (5set)				
05-019/cald	30-332200	lumina alba cald a - 14Lumen/LED	1	
05-019/rece	30-33220	lumina alba rece - 18Lumen/LED	1	

LANT DIN ALUMINIU CU 60LED 12VDC IP65

COD DABLEROM	COD PRODUCATOR	DENUMIRE	PAC.	PRET €
lant din aluminiu cu 60LED (20bare x 3LED=60LED) - 12VDC - IP65 - 14.4W/set- L:2m/set bara:W:12mm h:9mm L:60mm - prelungire max.6m (3set)				
05-020/cald	30-33200	lumina alba cald a - 14Lumen/LED	1	
05-020/rece	30-3320	lumina alba rece - 18Lumen/LED	1	
05-020/rosu	30-3322	lumina rosie	1	
05-020/albastru	30-3324	lumina albastru	1	
05-020/verde	30-3325	lumina verde	1	
05-020/RGB	30-3321	lumina RGB	1	



TRANSFORMATOARE PT. BENZI CU LED 220-240V/12VDC

COD DABLEROM	COD PRODUCATOR	DENUMIRE	PAC.	PRET €
transformatoare 220-240V/12VDC carcasa din plastic				
05-030/6	30-336126	6W - L:57mm W:34mm h:20mm	1	
05-030/15	30-3361215	15W - L:120mm W:45mm h:20mm	1	
05-030/24	30-3361224	24W - L:126mm W:50mm h:31mm	1	
05-030/30	30-3361230	30W - L:150mm W:40mm h:30mm	1	

transformatoare 220-240V/12VDC carcasa din metal				
05-030/50	30-3361240	50W - L:160mm W:100mm h:40mm	1	
03-030/100	30-33612100	100W - L:200mm W:100mm h:40mm	1	
05-030/150	30-33612150	150W - L:200mm W:110mm h:50mm	1	
05-030/200	30-33612200	200W - L:200mm W:110mm h:50mm	1	
05-030/350	30-33612350	350W - L:200mm W:110mm h:50mm	1	

TRANSFORMATOARE PT. BENZI CU LED 220-240V/12VDC IP67

COD DABLEROM	COD PRODUCATOR	DENUMIRE	PAC.	PRET €
transformatoare 220-240V/12VDC IP67 carcasa din aluminiu				
05-0307/60	30-33612401	60W - L:147.5mm W:70mm h:40mm	1	
05-0307/100	30-336121001	100W - L:190.5mm W:70mm h:40mm	1	
05-0307/150	30-336121501	150W - L:190.5mm W:70mm h:40mm	1	
05-0307/200	30-336122001	200W - L:198mm W:98mm h:52mm	1	

TRANSFORMATOARE PT. BENZI CU LED 220-240V/24VDC

COD DABLEROM	COD PRODUCATOR	DENUMIRE	PAC.	PRET €
transformatoare 220-240V/24VDC carcasa din plastic				
05-040/6	30-336247	6W - L:57mm W:34mm h:20mm	1	
05-040/15	30-3362415	15W - L:120mm W:45mm h:20mm	1	
05-040/30	30-3362430	30W - L:150mm W:40mm h:30mm	1	

transformatoare 220-240V/24VDC carcasa din metal				
05-040/50	30-336240	50W - L:160mm W:100mm h:40mm	1	
03-040/100	30-33624100	100W - L:200mm W:100mm h:40mm	1	
05-040/150	30-33624150	150W - L:200mm W:100mm h:40mm	1	
05-040/200	30-33624200	200W - L:200mm W:100mm h:40mm	1	
05-040/350	30-33624350	350W - L:200mm W:100mm h:40mm	1	

TRANSFORMATOARE PT. BENZI CU LED 220-240V/24VDC IP67

COD DABLEROM	COD PRODUCATOR	DENUMIRE	PAC.	PRET €
transformatoare 220-240V/24VDC IP67 carcasa din aluminiu				
05-0407/60	30-33624401	60W - L:147.5mm W:70mm h:40mm	1	
05-0407/150	30-336241501	150W - L:190.5mm W:70mm h:40mm	1	



DIMMERE PT. BENZI CU LED MONOCOLORE

COD DABLEROM	COD PRODUCATOR	DENUMIRE	PAC.	PRET €
dimmer pe tencuiala cu reglaj manual & telecomanda L:87mm W:87mm h:53mm				
05-0500	30-332	12VDC 8A/96W sau 24VDC 8A/192W	1	

dimmer cu telecomanda L:110mm W:56mm h:34mm				
05-0501/12	30-31012	12VDC 8A/96W	1	
05-0501/24	30-31024	24VDC 8A/192W	1	

dimmer pe tencuiala cu reglaj manual L:89mm W:59mm h:35mm				
05-0502	30-331120	12VDC 8A/96W sau 24VDC 8A/192W	1	



75



30-31012V
30-31024V



DIMMERE & CONTROLLERE PT. BENZI CU LED RGB

COD DABLEROM	COD PRODUCATOR	DENUMIRE	PAC.	PRET €
dimmer & controller cu telecomanda L:35mm W:25mm h:20mm				
05-050	30-3200121	12VDC 6A/72W total (2A/24w/culoare)	1	
05-050/24	30-320124	24VDC 6A/144W total (2A/48w/culoare)	1	



dimmer & controller cu reglaj manual & telecomanda L:121mm W:51mm h:26mm				
05-056	30-33368	12VDC 15A/180W total (5A/60w/culoare)	1	
		24VDC 15A/360W total (5A/120w/culoare)		



05-056

dimmer & controller cu telecomanda - se poate conecta cu consola DMX-512 L:175mm W:35mm h:45mm				
05-057	30-305	12VDC 15A/180W total (5A/60w/culoare)	1	
		24VDC 15A/360W total (5A/120w/culoare)		
05-058	30-3051	cablu calculator 2m cu stecker RJ45 8P8C	1	
05-059	30-3052	cablu adaptor 1m pt. consola DMX-512	1	



AMPLIFICATOARE DE PUTERE PT. BENZI CU LED RGB

COD DABLEROM	COD PRODUCATOR	DENUMIRE	PAC.	PRET €
amplificator de putere pentru benzi RGB L:98mm W:45mm h:18mm				
05-049/12	30-32212	12VDC 12A/144W total (4A/48w/culoare)	1	
05-049/24	30-32224	24VDC 12A/288W total (4A/96w/culoare)	1	



februarie 2012

COD DABLEROM	COD PRODUCATOR	DENUMIRE	PAC.	PRET €
tub luminos cu becuri 1 canal (2 fire) - Ø13mm - 230V AC -36bec./metru - 16.4W/m posibilitate :taiere min.1m - fiecare cutie are 5 cablu alimentare,5 mufe & 5 capace				
30-2101	30-2101	alb	100	
30-2111	30-2111	multicolor	100	
30-2121	30-2121	rosu	100	
30-2131	30-2131	galben	100	
30-2141	30-2141	albastru	100	
30-2151	30-2151	verde	100	



accesorii pentru tub luminos cu becuri 1 canal (2 fire) - Ø13mm - 230V AC				
30-5016	30-5016	programator pt. 50m 4A(900W) IP44	80/1	
30-5003	30-5003	set cablu	5	
30-5005	30-5005	mufa de imbinare liniara	10	
30-5013	30-5013	mufa de imbinare "T"	10	
30-50130	30-50130	mufa de imbinare cruce "+"	10	
30-5002	30-5002	capac	50	
30-5000	30-5000	sistem de prindere pe perete	10	



TUB LUMINOS 2 CANALE CU BECURI & ACCESORII

COD DABLEROM	COD PRODUCATOR	DENUMIRE	PAC.	PRET €
tub luminos cu becuri 2 canale (3 fire) - Ø13mm - 230V AC -36bec./metru - 16.4W/m posibilitate :taiere min.2m - fiecare cutie are 5 cablu alimentare,5 mufe & 5 capace				
30-2201	30-2201	alb	100	
30-2211	30-2211	multicolor	100	
30-2221	30-2221	rosu	100	
30-2231	30-2231	galben	100	
30-2241	30-2241	albastru	100	
30-2251	30-2251	verde	100	
30-2271	30-2271	mov	100	



accesorii pentru tub luminos cu becuri 2 canale (3 fire) - Ø13mm - 230V AC				
30-5027	30-5027	programator pt. 25m 2A(450W) IP20	5	
30-5022	30-5022	programator pt. 50m 4A(900W) IP44	80/1	
30-50210	30-50210	programator pt. 140m 10A(2300W) IP20	20/1	
30-5004	30-5004	set cablu	10	
30-5006	30-5006	mufa de imbinare liniara	20	
30-5014	30-5014	mufa de imbinare "T"	10	
30-50140	30-50140	mufa de imbinare cruce "+"	10	
30-5002	30-5002	capac	50	
30-5000	30-5000	sistem de prindere pe perete	10	



TUB LUMINOS 1 CANAL CU LED & ACCESORII

77

COD DABLEROM	COD PRODUCATOR	DENUMIRE	PAC.	PRET €
tub luminos cu LED 1 canal (2 fire) - Ø13mm - 230V AC -36bec./metru - 3W/m posibilitate :taiere min.1m - fiecare cutie are 5 cablu alimentare,5 mufe & 5 capace				
30-250	30-250	alb cald	50	
30-2500	30-2500	alb rece	50	
30-2503	30-2503	galben	50	
30-2504	30-2504	albastru	50	
30-2505	30-2505	verde	50	

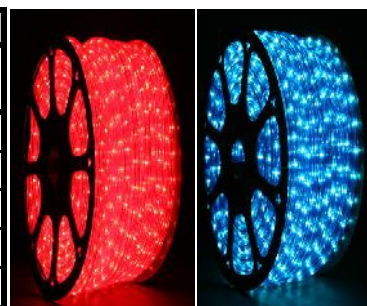

accesorii pentru tub luminos cu LED 1 canal (2 fire) - Ø13mm - 230V AC				
30-50083	30-50083	set cablu	10	
30-5005	30-5005	mufa de imbinare liniara	10	
30-5002	30-5002	capac	50	
30-5000	30-5000	sistem de prindere pe perete	10	



TUB LUMINOS 2 CANALE CU LED & ACCESORII

COD DABLEROM	COD PRODUCATOR	DENUMIRE	PAC.	PRET €
tub luminos cu LED 2 canale (3 fire) - Ø13mm - 230V AC -36bec./metru - 3W/m posibilitate :taiere min.2m - fiecare cutie are 5 cablu alimentare,5 mufe & 5 capace				
30-26000	30-26000	alb cald	50	
30-2600	30-2600	alb rece	50	
30-2610	30-2610	multicolor	50	
30-2602	30-2602	rosu	50	
30-2603	30-2603	galben	50	
30-2604	30-2604	albastru	50	
30-2605	30-2605	verde	50	
30-2607	30-2607	mov	50	

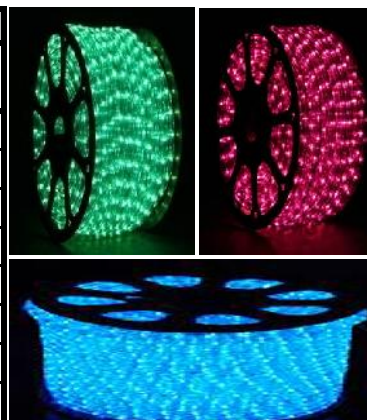

accesorii pentru tub luminos cu LED 2 canale (3 fire) - Ø13mm - 230V AC				
30-50350	30-50350	programator pt. 50m 2A(450W) IP20	5	
30-503100	30-503100	programator pt. 100m 4A(900W) IP20	60/1	
30-50084	30-50084	set cablu 2A (450W) IP44	5	
30-5006	30-5006	mufa de imbinare liniara	20	
30-5002	30-5002	capac	50	
30-5000	30-5000	sistem de prindere pe perete	10	



februarie 2012

BECURI ECONOMICE SPIRAL MINI E14 240V



COD DABLEROM	COD PRODUCATOR	DENUMIRE	lumina	lumen	PAC.	PRET €
bec economic spiral mini E14 240V - lumina calda 2700k - 8000h						
00-764/3	14-501436	3W - L:81mm D:32mm	calda	115	100/10	
00-764/7	14-501476	7W - L:85mm D:32mm	calda	330	100/10	
00-764/9	14-501496	9W - L:95mm D:32mm	calda	420	100/10	
00-764/11	14-5014116	11W - L:102mm D:32mm	calda	560	100/10	
00-764/13	14-5014136	13W - L:106mm D:38mm	calda	680	80/10	
00-764/15	14-5014156	15W - L:108mm D:38mm	calda	820	80/10	
00-764/20	14-5014206	20W - L:115mm D:46mm	calda	1200	100/10	
00-764/23	14-5014236	23W - L:132mm D:46mm	calda	1552	100/10	
00-764/25	14-5014256	25W - L:132mm D:46mm	calda	1600	100/10	
00-764/26	14-5014266	26W - L:122mm D:53mm	calda	1640	60/10	

bec economic spiral mini E14 240V - lumina alba 4000k - 8000h						
00-7651/7	14-501471	7W - L:85mm D:32mm	alba	310	100/10	
00-7651/9	14-501491	9W - L:95mm D:32mm	alba	415	100/10	
00-7651/11	14-5014111	11W - L:102mm D:32mm	alba	550	100/10	
00-7651/13	14-5014131	13W - L:106mm D:38mm	alba	670	80/10	
00-7651/15	14-5014151	15W - L:108mm D:38mm	alba	800	80/10	
00-7651/20	14-5014201	20W - L:115mm D:46mm	alba	1180	100/10	
00-7651/23	14-5014231	23W - L:132mm D:46mm	alba	1508	100/10	
00-7651/26	14-5014261	26W - L:122mm D:53mm	alba	1620	60/10	

bec economic spiral mini E14 240V - lumina rece 6400k - 8000h						
00-765/3	14-501437	3W - L:81mm D:32mm	rece	105	100/10	
00-765/7	14-501477	7W - L:85mm D:32mm	rece	290	100/10	
00-765/9	14-501497	9W - L:95mm D:32mm	rece	410	100/10	
00-765/11	14-5014117	11W - L:102mm D:32mm	rece	535	100/10	
00-765/13	14-5014137	13W - L:106mm D:38mm	rece	660	80/10	
00-765/15	14-5014157	15W - L:108mm D:38mm	rece	780	80/10	
00-765/20	14-5014207	20W - L:115mm D:46mm	rece	1160	100/10	
00-765/23	14-5014237	23W - L:132mm D:46mm	rece	1464	100/10	
00-765/25	14-5014257	25W - L:132mm D:46mm	rece	1520	100/10	
00-765/26	14-5014267	26W - L:122mm D:53mm	rece	1600	60/10	



BECURI ECONOMICE SPIRAL E14 240V CU 100.000 APRINDERI

COD DABLEROM	COD PRODUCATOR	DENUMIRE	lumina	lumen	PAC.	PRET €
bec economic spiral E14 240V cu 100.000 aprinderi (special pt. senzori etc.) - 4000k						
00-76519/11	14-50149111	11W - L:101mm D:42mm	alba	550	100/10	
00-76519/15	14-50149151	15W - L:118mm D:49mm	alba	800	100/10	
00-76519/20	14-50149201	20W - L:128mm D:49mm	alba	1155	100/10	



BECURI ECONOMICE SPIRAL T3 E14 240V DIMABILE

COD DABLEROM	COD PRODUCATOR	DENUMIRE	lumina	lumen	PAC.	PRET €
bec economic spiral E14 240V dimabile - lumina calda 2700k						
00-7648/11	14-50148116	11W - L:119mm D:44mm	calda	567	100/10	
00-7648/15	14-50148156	15W - L:113mm D:48mm	calda	850	100/10	

bec economic spiral E14 240V dimabile - lumina alba 4000k						
00-76518/11	14-50148111	11W - L:119mm D:44mm	alba	551	100/10	
00-76518/15	14-50148151	15W - L:113mm D:48mm	alba	800	100/10	



BECURI ECONOMICE E14 240V 2U

COD DABLEROM	COD PRODUCATOR	DENUMIRE	lumina	lumen	PAC.	PRET €
bec economic E14 240V 2U - lumina calda 2700k - 8000h						
00-720/9	14-514296	9W - L:127mm D:38mm	calda	450	100/10	
00-720/13	14-5142136	13W - L:147mm D:38mm	calda	700	100/10	
00-720/15	14-5142156	15W - L:153mm D:38mm	calda	840	100/10	

bec economic E14 240V 2U- lumina rece 6400k - 8000h						
00-721/7	14-514277	7W - L:118mm D:38mm	rece	300	100/10	
00-721/9	14-514297	9W - L:127mm D:38mm	rece	430	100/10	
00-721/11	14-5142117	11W - L:136mm D:38mm	rece	530	100/10	
00-721/13	14-5142137	13W - L:147mm D:38mm	rece	660	100/10	
00-721/15	14-5142157	15W - L:153mm D:38mm	rece	800	100/10	



BECURI ECONOMICE E14 240V 4U

COD DABLEROM	COD PRODUCATOR	DENUMIRE	lumina	lumen	PAC.	PRET €
bec economic E14 240V 4U - lumina calda 2700k - 8000h						
00-724/9	14-51496	9W - L:97mm D:47mm	calda	420	100/10	
00-724/11	14-514116	11W - L:106mm D:47mm	calda	560	100/10	
00-724/13	14-514136	13W - L:106mm D:47mm	calda	715	100/10	
00-724/15	14-514156	15W - L:111mm D:47mm	calda	850	100/10	
00-724/18	14-514186	18W - L:117mm D:47mm	calda	1050	100/10	

bec economic E14 240V 4U- lumina rece 6400k - 8000h						
00-725/9	14-51497	9W - L:97mm D:47mm	rece	410	100/10	
00-725/11	14-514117	11W - L:106mm D:47mm	rece	550	100/10	
00-725/13	14-514137	13W - L:106mm D:47mm	rece	680	100/10	
00-725/18	14-514187	18W - L:135mm D:47mm	rece	1100	100/10	



BECURI ECONOMICE SPIRAL E14 240V COLORATE

COD DABLEROM	COD PRODUCATOR	DENUMIRE	lumina	PAC.	PRET €
bec economic spiral E14 240V colorate - 8000h					
00-7284/R	14-514152	15W - L:105mm D:44mm	rosie	108/12	
00-7284/G	14-514153	15W - L:105mm D:44mm	galbena	108/12	
00-7284/A	14-514154	15W - L:105mm D:44mm	albastra	108/12	
00-7284/V	14-514155	15W - L:105mm D:44mm	verde	108/12	



BECURI ECONOMICE SPIRAL MINI E27 240V



COD DABLEROM	COD PRODUCATOR	DENUMIRE	lumina	lumen	PAC.	PRET €
bec economic spiral mini E27 240V - lumina calda 2700k - 8000h						
00-766/3	14-502736	3W - L:77mm D:32mm	calda	115	100/10	
00-766/7	14-502776	7W - L:90mm D:32mm	calda	330	100/10	
00-766/9	14-502796	9W - L:92mm D:32mm	calda	420	100/10	
00-766/11	14-5027116	11W - L:100mm D:32mm	calda	560	100/10	
00-766/13	14-5027136	13W - L:104mm D:38mm	calda	750	100/10	
00-766/15	14-5027156	15W - L:105mm D:38mm	calda	820	80/10	
00-7666/15	14-50027156	15W - L:95mm D:46mm	calda	820	100/10	
00-766/20	14-5027206	20W - L:117mm D:49mm	calda	1200	100/10	
00-7666/20	14-50027206	20W - L:94mm D:60mm	calda	1200	100/10	
00-766/23	14-5027236	23W - L:130mm D:45mm	calda	1552	100/10	
00-766/25	14-5027256	25W - L:100mm D:60mm	calda	1600	100/10	
00-766/26	14-5027266	26W - L:122mm D:53mm	calda	1640	60/10	
00-766/30	14-5027306	30W - L:134mm D:65mm	calda	1950	40/10	
00-766/36	14-5027366	36W - L:175mm D:61mm	calda	2560	20/10	
00-766/40	14-5027406	40W - L:145mm D:72mm	calda	2740	40/10	
00-766/65	14-5027656	65W - L:220mm D:75mm	calda	3450	6	
00-766/85	14-527856	85W - L:295mm D:95mm	calda	4400	6	



bec economic spiral mini E27 240V - lumina rece 6400k - 8000h						
00-767/3	14-502737	3W - L:77mm D:32mm	rece	105	100/10	
00-767/7	14-502777	7W - L:90mm D:32mm	rece	290	100/10	
00-767/9	14-502797	9W - L:92mm D:32mm	rece	410	100/10	
00-767/11	14-5027117	11W - L:100mm D:32mm	rece	535	100/10	
00-767/13	14-5027137	13W - L:104mm D:38mm	rece	660	100/10	
00-767/15	14-5027157	15W - L:105mm D:38mm	rece	780	80/10	
00-7677/15	14-50027157	15W - L:95mm D:46mm	rece	780	100/10	
00-767/20	14-5027207	20W - L:117mm D:49mm	rece	1160	100/10	
00-7677/20	14-50027207	20W - L:94mm D:60mm	rece	1160	100/10	
00-767/23	14-5027237	23W - L:130mm D:45mm	rece	1464	100/10	
00-767/25	14-5027257	25W - L:100mm D:60mm	rece	1520	100/10	
00-767/26	14-5027267	26W - L:122mm D:53mm	rece	1600	60/10	
00-767/30	14-5027307	30W - L:134mm D:65mm	rece	1900	40/10	
00-767/36	14-5027367	36W - L:175mm D:61mm	rece	2370	20/10	
00-767/40	14-5027407	40W - L:145mm D:72mm	rece	2670	40/10	
00-727/65	14-5027657	65W - L:220mm D:75mm	rece	3400	6	
00-727/85	14-527857	85W - L:295mm D:95mm	rece	4200	6	

BECURI ECONOMICE SPIRAL MINI E27 240V

COD DABLEROM	COD PRODUCATOR	DENUMIRE	lumina	lumen	PAC.	PRET €
bec economic spiral mini E27 240V - lumina alba 4000k - 8000h						
00-768/7	14-502771	7W - L:90mm D:32mm	alba	310	100/10	
00-768/9	14-502791	9W - L:92mm D:32mm	alba	415	100/10	
00-768/11	14-5027111	11W - L:100mm D:38mm	alba	550	100/10	
00-768/13	14-5027131	13W - L:104mm D:38mm	alba	670	100/10	
00-768/15	14-5027151	15W - L:105mm D:38mm	alba	800	80/10	
00-7688/15	14-50027151	15W - L:95mm D:46mm	alba	800	100/10	
00-768/20	14-5027201	20W - L:117mm D:49mm	alba	1180	100/10	
00-7688/20	14-50027201	20W - L:94mm D:60mm	alba	1180	100/10	
00-768/23	14-5027231	23W - L:130mm D:45mm	alba	1508	100/10	
00-768/25	14-5027251	25W - L:100mm D:60mm	alba	1560	100/10	
00-768/26	14-5027261	26W - L:122mm D:53mm	alba	1620	60/10	
00-768/30	14-5027301	30W - L:134mm D:65mm	alba	1930	40/10	
00-768/36	14-5027361	36W - L:175mm D:61mm	alba	2465	20/10	
00-768/40	14-5027401	40W - L:145mm D:72mm	alba	2700	40/10	
00-768/65	14-5027651	65W - L:220mm D:75mm	alba	3430	6	
00-768/85	14-527851	85W - L:295mm D:95mm	alba	4300	6	



BECURI ECONOMICE SPIRAL E27 240V CU 100.000 APRINDERI

COD DABLEROM	COD PRODUCATOR	DENUMIRE	lumina	lumen	PAC.	PRET €
bec economic spiral E27 240V cu 100.000 aprinderi (special pt. senzori etc.) - 4000k						
00-7689/11	14-50279111	11W - L:101mm D:42mm	alba	550	100/10	
00-7689/15	14-50279151	15W - L:118mm D:49mm	alba	800	100/10	
00-7689/20	14-50279201	20W - L:128mm D:49mm	alba	1155	100/10	



BECURI ECONOMICE SPIRAL T3 E27 240V DIMABILE

COD DABLEROM	COD PRODUCATOR	DENUMIRE	lumina	lumen	PAC.	PRET €
bec economic spiral E27 240V dimabile - lumina calda 2700k						
00-71968/11	14-50278116	11W - L:120mm D:44mm	calda	567	100/10	
00-71968/15	14-50278156	15W - L:112mm D:48mm	calda	848	100/10	
00-71968/20	14-50278206	20W - L:121mm D:48mm	calda	1224	100/10	
00-71968/23	14-50278236	23W - L:125mm D:48mm	calda	1452	100/10	



bec economic spiral E27 240V dimabile - lumina alba 4000k

00-719618/11	14-50278111	11W - L:120mm D:44mm	alba	551	100/10	
00-719618/15	14-50278151	15W - L:112mm D:48mm	alba	824	100/10	
00-719618/20	14-50278201	20W - L:121mm D:48mm	alba	1190	100/10	
00-719616/23	14-50278231	23W - L:125mm D:48mm	alba	1411	100/10	

bec economic spiral E27 240V dimabile - lumina rece 6400k

00-7197/23	14-50278237	23W - L:136mm D:55mm	rece	1468	100/10	
------------	-------------	----------------------	------	------	--------	--

BECURI ECONOMICE E27 240V 2U/3U

COD DABLEROM	COD PRODUCATOR	DENUMIRE	lumina	lumen	PAC.	PRET €
bec economic E27 240V 2U/3U - lumina calda 2700k - 8000h						
00-722/7	14-527276 - 2U	7W - L:114mm D:38mm	calda	350	100/10	
00-722/9	14-527296 - 2U	9W - L:124mm D:38mm	calda	450	100/10	
00-722/11	14-5272116 - 2U	11W - L:133mm D:38mm	calda	560	100/10	
00-722/13	14-5272136 - 2U	13W - L:143mm D:38mm	calda	700	100/10	
00-722/15	14-5272156 - 2U	15W - L:149mm D:38mm	calda	840	100/10	
00-722/20	14-52733206- 3U	20W - L:145mm D:38mm	calda	1200	100/10	

bec economic E27 240V 2U/3U- lumina rece 6400k - 8000h						
00-723/7	14-527277 - 2U	7W - L:114mm D:38mm	rece	300	100/10	
00-723/9	14-527297 - 2U	9W - L:124mm D:38mm	rece	430	100/10	
00-723/11	14-5272117 - 2U	11W - L:133mm D:38mm	rece	530	100/10	
00-723/13	14-5272137 - 2U	13W - L:143mm D:38mm	rece	660	100/10	
00-723/15	14-5272157 - 2U	15W - L:149mm D:38mm	rece	800	100/10	
00-723/20	14-52733207- 3U	20W - L:145mm D:38mm	rece	1155	100/10	



82

BECURI ECONOMICE E27 240V 4U

COD DABLEROM	COD PRODUCATOR	DENUMIRE	lumina	lumen	PAC.	PRET €
bec economic E27 240V 4U - lumina calda 2700k - 8000h						
00-726/9	14-52796	9W - L:95mm D:47mm	calda	420	100/10	
00-726/11	14-527116	11W - L:105mm D:47mm	calda	560	100/10	
00-726/13	14-527136	13W - L:116mm D:47mm	calda	715	100/10	
00-726/15	14-527156	15W - L:124mm D:47mm	calda	850	100/10	
00-726/18	14-527186	18W - L:135mm D:47mm	calda	1050	100/10	
00-726/20	14-527206	20W - L:146mm D:47mm	calda	1250	100/10	

COD DABLEROM	COD PRODUCATOR	DENUMIRE	lumina	lumen	PAC.	PRET €
bec economic E27 240V 4U - lumina rece 6400k - 8000h						
00-727/9	14-52797	9W - L:95mm D:47mm	rece	410	100/10	
00-727/11	14-527117	11W - L:105mm D:47mm	rece	520	100/10	
00-727/13	14-527137	13W - L:116mm D:47mm	rece	680	100/10	
00-727/15	14-527157	15W - L:124mm D:47mm	rece	800	100/10	
00-727/18	14-527187	18W - L:135mm D:47mm	rece	1010	100/10	
00-727/20	14-527207	20W - L:146mm D:47mm	rece	1150	100/10	



BECURI ECONOMICE E27 240V 6U

COD DABLEROM	COD PRODUCATOR	DENUMIRE	lumina	lumen	PAC.	PRET €
bec economic E27 240V 6U - lumina calda 2700k - 8000h						
00-7266/11	14-52761166	11W - L:95mm D:44mm	calda	580	100/10	
00-7266/15	14-52761566	15W - L:102mm D:44mm	calda	840	100/10	
00-7266/20	14-52762066	20W - L:116mm D:44mm	calda	1200	100/10	
00-7266/25	14-52762566	25W - L:125mm D:44mm	calda	1580	60/12	
00-7266/85	14-50276856	85W - L:270mm D:106mm	calda	4450	6	
00-7266/105	14-502761056	105W-L:285mm D:111mm	calda	5400	6	
00-7266/120	14-502761206	120W-L:300mm D:105mm	calda	6500	6	
00-7266/150	14-502761506	150W-L:335mm D:105mm	calda	7800	6	



bec economic E27 240V 6U - lumina rece 6400k - 8000h						
00-7267/11	14-52761167	11W - L:95mm D:44mm	rece	560	100/10	
00-7267/15	14-52761567	15W - L:102mm D:44mm	rece	800	100/10	
00-7267/20	14-52762067	20W - L:116mm D:44mm	rece	1155	100/10	
00-7267/25	14-52762567	25W - L:125mm D:44mm	rece	1520	60/12	
00-7267/85	14-50276857	85W - L:270mm D:106mm	rece	4250	10	
00-7267/105	14-502761057	105W-L:285mm D:111mm	rece	5150	10	
00-7267/120	14-502761207	120W-L:300mm D:105mm	rece	6250	10	
00-7267/150	14-502761507	150W-L:335mm D:105mm	rece	7400	6	



BECURI ECONOMICE SPIRAL E27 T3 12VDC

COD DABLEROM	COD PRODUCATOR	DENUMIRE	lumina	lumen	PAC.	PRET €
bec economic spiral E27 T3 12VDC - lumina calda 2700k - 8000h						
00-72212/11	14-50274116	11W - L:122mm D:40mm	calda	631	100/10	
00-72212/15	14-50274156	15W - L:133mm D:40mm	calda	848	100/10	
00-72212/20	14-50274206	20W - L:141mm D:40mm	calda	1224	100/10	

bec economic spiral E27 T3 12VDC - lumina rece 6400k - 8000h						
00-72312/11	14-50274117	11W - L:122mm D:40mm	rece	595	100/10	
00-72312/15	14-50274157	15W - L:133mm D:40mm	rece	800	100/10	
00-72312/20	14-50274207	20W - L:141mm D:40mm	rece	1155	100/10	



BECURI ECONOMICE SPIRAL E27 T3 24VDC

COD DABLEROM	COD PRODUCATOR	DENUMIRE	lumina	lumen	PAC.	PRET €
bec economic spiral E27 T3 24VDC - lumina rece 6400k - 8000h						
00-72324/11	14-50276117	11W - L:122mm D:40mm	rece	595	100/10	
00-72324/15	14-50276157	15W - L:133mm D:40mm	rece	800	100/10	
00-72324/20	14-50276207	20W - L:141mm D:40mm	rece	1155	100/10	



BECURI ECONOMICE SPIRAL E27 240V COLORATE

COD DABLEROM	COD PRODUCATOR	DENUMIRE	lumina	PAC.	PRET €
bec economic spiral E27 240V colorate - 8000h					
00-728/B	14-5271511	15W - L:105mm D:44mm	black light	80/10	
00-728/R	14-527152	15W - L:105mm D:44mm	rosie	80/10	
00-728/G	14-527153	15W - L:105mm D:44mm	galbena	80/10	
00-728/A	14-527154	15W - L:105mm D:44mm	albastra	80/10	
00-728/V	14-527155	15W - L:105mm D:44mm	verde	80/10	

**BECURI ECONOMICE SPIRAL E27 240V ANTIINSECTE**

COD DABLEROM	COD PRODUCATOR	DENUMIRE	lumina	PAC.	PRET €
bec economic spiral E27 240V antiinsecte - 10000h					
00-731	14-5271838	18W - L:155mm D:57mm	galbena	100/10	

**BECURI ECONOMICE E27 240V TIP "SL" PENTRU EXTERIOR**

COD DABLEROM	COD PRODUCATOR	DENUMIRE	lumina	lumen	PAC.	PRET €
bec economic E27 240V tip "SL" pentru exterior - 8000h						
00-719/cald	14-2256	25W - L:170mm D:63mm	calda	1643	40/10	
00-719/rece	14-2251	25W - L:170mm D:63mm	rece	1550	40/10	

**BECURI ECONOMICE E27 240V 3U CU FOTOCELULA**

COD DABLEROM	COD PRODUCATOR	DENUMIRE	lumina	lumen	PAC.	PRET €
bec economic E27 240V 3U cu fotocelula - 10000h						
00-7306/15	14-5273156	15W - L:140mm D:58mm	calda	850	100/10	
00-7306/20	14-5273206	20W - L:155mm D:58mm	calda	1230	100/10	

**BECURI ECONOMICE E27 240V 3U CU FOTOCELULA & REGLAJ LUX**

COD DABLEROM	COD PRODUCATOR	DENUMIRE	lumina	lumen	PAC.	PRET €
bec economic E27 240V 3U cu fotocelula si reglaj pentru lux - 10000h						
00-73066/15	14-52730156	15W - L:140mm D:58mm	calda	848	100/10	
00-73066/20	14-52730206	20W - L:155mm D:58mm	calda	1224	100/10	
00-73077/15	14-52730157	15W - L:140mm D:58mm	rece	824	100/10	
00-73077/20	14-52730207	20W - L:155mm D:58mm	rece	1190	100/10	



BECURI ECONOMICE SPIRAL E40 240V

COD DABLEROM	COD PRODUCATOR	DENUMIRE	lumina	lumen	PAC.	PRET €
bec economic spiral E40 240V - lumina calda 2700k - 8000h						
00-7296/65	14-5040656	65W - L:235mm D:75mm	calda	3450	6	
00-7296/85	14-540856	85W - L:305mm D:95mm	calda	4400	6	
00-7296/105	14-5401056	105W -L:335mm D:95mm	calda	5500	6	

bec economic spiral E40 240V - lumina rece 6400k - 8000h

00-7297/65	14-5040657	65W - L:235mm D:75mm	rece	3400	6	
00-7297/105	14-5401057	105W -L:335mm D:95mm	rece	5300	6	
00-7297/120	14-5401207	120W -L:355mm D:95mm	rece	6200	6	

BECURI ECONOMICE E40 240V 6U

COD DABLEROM	COD PRODUCATOR	DENUMIRE	lumina	lumen	PAC.	PRET €
bec economic 6U E40 240V - lumina calda 2700k - 8000h						
00-7276/85	14-5406856	85W - L:275mm D:106mm	calda	4450	6	
00-7276/105	14-54061056	105W -L:300mm D:111mm	calda	5400	6	
00-7276/120	14-54061206	120W -L:320mm D:111mm	calda	6500	6	
00-7276/150	14-54061506	150W -L:355mm D:105mm	calda	7800	6	

bec economic 6U E40 240V - lumina alba 4000k - 8000h

00-7271/85	14-5406851	85W - L:275mm D:106mm	alba	4350	10	
00-7271/105	14-54061051	105W -L:300mm D:111mm	alba	5250	10	
00-7271/120	14-54061201	120W -L:320mm D:111mm	alba	6350	10	
00-7271/150	14-54061501	150W -L:355mm D:105mm	alba	7600	6	

bec economic 6U E40 240V - lumina rece 6400k - 8000h

00-7277/85	14-5406857	85W - L:275mm D:106mm	rece	4250	6	
00-7277/105	14-54061057	105W -L:300mm D:111mm	rece	5150	6	
00-7277/120	14-54061207	120W -L:320mm D:111mm	rece	6250	10	
00-7277/150	14-54061507	150W -L:355mm D:105mm	rece	7400	6	

BECURI ECONOMICE E40 240V 8U

COD DABLEROM	COD PRODUCATOR	DENUMIRE	lumina	lumen	PAC.	PRET €
bec economic 8U E40 240V - lumina calda 2700k - 8000h						
00-7316/150	14-54081506	150W -L:330mm D:125mm	calda	7650	6	
00-7316/200	14-54082006	200W -L:345mm D:125mm	calda	9800	6	

bec economic 8U E40 240V - lumina rece 6400k - 8000h

00-7317/200	14-54082007	200W -L:345mm D:125mm	rece	9600	6	
-------------	-------------	-----------------------	------	------	---	--



BECURI HALOGENE "ECO" LUMANARE E14 230V

COD DABLEROM	COD PRODUCATOR	DENUMIRE	STICLA	PAC.	PRET €
bec halogen ECO lumanare E14 230V - L:100mm D:35mm					
00-60018/T	14-7018	18W (echivalent 25W)	transparent	100/10	
00-60028/T	14-7028	28W (echivalent 40W)	transparent	100/10	
00-60042/T	14-7042	42W (echivalent 60W)	transparent	100/10	

00-60018/M	14-70181	18W (echivalent 25W)	mat	100/10	
00-60028/M	14-70281	28W (echivalent 40W)	mat	100/10	
00-60042/M	14-70421	42W (echivalent 60W)	mat	100/10	

00-60028/L	14-702800	28W (echivalent 40W)	laptos	100/10	
00-60042/L	14-704200	42W (echivalent 60W)	laptos	100/10	

**BECURI ECONOMICE LUMANARE E14 240V**

COD DABLEROM	COD PRODUCATOR	DENUMIRE	lumina	lumen	PAC.	PRET €
bec economic lumanare E14 240V - lumina calda 2700k - 8000h						
00-732/cald	14-5140056	5W - L:104mm D:38mm	calda	190	120/10	
00-733/cald	14-5140076	7W - L:104mm D:38mm	calda	300	100/10	
00-7326/11	14-5140116	11W- L:108mm D:38mm	calda	545	120/10	
00-7326/13	14-51400136	13W- L:121mm D:42mm	calda	685	100/10	

bec economic lumanare E14 240V - lumina alba 4000k - 8000h						
00-732/alb	14-5140051	5W - L:104mm D:38mm	alba	180	120/10	
00-733/alb	14-5140071	7W - L:104mm D:38mm	alba	295	100/10	
00-7321/11	14-5140111	11W- L:108mm D:38mm	alba	540	120/10	
00-7321/13	14-51400131	13W- L:121mm D:42mm	alba	675	100/10	

bec economic lumanare E14 240V - lumina rece 6400k - 8000h						
00-732/rece	14-5140057	5W - L:104mm D:38mm	rece	176	120/10	
00-733/rece	14-5140077	7W - L:104mm D:38mm	rece	290	100/10	
00-734/rece	14-514107	10W- L:107mm D:38mm	rece	470	100/10	
00-7327/11	14-5140117	11W- L:108mm D:38mm	rece	535	120/10	
00-7327/13	14-51400137	13W- L:121mm D:42mm	rece	665	100/10	

BECURI LUMANARE CU POWER LED "MULTI CHIP" E14 230V

COD DABLEROM	COD PRODUCATOR	DENUMIRE	lumina	lumen	PAC.	PRET €
bec lumanare cu power led "multi chip" E14 230V						
06-732/cald	13-1400300	3W - L:102mm D:38mm	calda	190	50/10	
06-732/rece	13-140030	3W - L:102mm D:38mm	rece	210	50/10	

BECURI ECONOMICE DIMABILE LUMANARE E14 240V

COD DABLEROM	COD PRODUCATOR	DENUMIRE	lumina	lumen	PAC.	PRET €
bec economic lumanare dimabil E14 230V						
00-73268/11	14-5148116	11W - L:121mm D:42mm	calda	567	100/10	
00-73218/11	14-5148111	11W - L:121mm D:42mm	alba	551	100/10	



BECURI INCANDESCENTE ORNAMENT LUMANARE E14 230V

COD DABLEROM	COD PRODUCATOR	DENUMIRE	STICLA	PAC.	PRET €
bec incandescent ornament lumanare E14 230V					
00-600	13-1040	40W	transparent	100/25	
00-601	13-1060	60W	transparent	100/25	

00-602	13-1140	40W	mat	100/25	
00-603	13-1160	60W	mat	100/25	

BECURI ECONOMICE ORNAMENT LUMANARE E14 240V

COD DABLEROM	COD PRODUCATOR	DENUMIRE	lumina	lumen	PAC.	PRET €
bec economic ornament lumanare E14 240V - 8000h						
00-737/cald	14-5141069	10W - L:140mm D:38mm	caldă	495	120/10	
00-737/alb	14-5141019	10W - L:140mm D:38mm	alba	488	100/10	
00-737/rece	14-5141079	10W - L:140mm D:38mm	rece	470	100/10	

BECURI ECONOMICE TIP PLAFONIERA GX 53 240V

COD DABLEROM	COD PRODUCATOR	DENUMIRE	lumina	lumen	PAC.	PRET €
bec economic tip plafoniera GX 53 240V - lumina caldă 2700k - 8000h						
00-7587/cald	14-41776	7W - h:24mm Ø:75mm	caldă	280	100/10	
00-7589/cald	14-41796	9W - h:28mm Ø:75mm	caldă	400	80/10	
00-75811/cald	14-417116	11W - h:29mm Ø:75mm	caldă	520	80/10	

bec economic tip plafoniera GX 53 240V - lumina alba 4000k - 8000h

00-7587/alb	14-41771	7W - h:24mm Ø:75mm	alba	275	100/10	
00-7589/alb	14-41791	9W - h:28mm Ø:75mm	alba	390	80/10	
00-75811/alb	14-417111	11W - h:29mm Ø:75mm	alba	510	80/10	

bec economic tip plafoniera GX 53 240V - lumina rece 6400k - 8000h

00-7587/rece	14-41777	7W - h:24mm Ø:75mm	rece	270	100/10	
00-7589/rece	14-41797	9W - h:28mm Ø:75mm	rece	380	200/20	
00-75811/rece	14-417117	11W - h:29mm Ø:75mm	rece	500	100/10	

soclu pentru bec GX 53

00-759	14-41770	soclu pentru bec GX53	100/10		
--------	----------	-----------------------	--------	--	--

BECURI TIP PLAFONIERA GX 53 CU 60LED 230V

COD DABLEROM	COD PRODUCATOR	DENUMIRE	lumina	lumen	PAC.	PRET €
bec tip plafoniera GX 53 CU 60LED 230V - 8000h						
00-762/cald	14-4176000	2.8W - h:24mm Ø:75mm	caldă	150	100/10	
00-762/rece	14-417600	2.8W - h:24mm Ø:75mm	rece	170	100/10	
00-762/albastru	14-41764	2.8W - h:24mm Ø:75mm	albastru		100/10	

soclu pentru bec GX 53

00-759	14-41770	soclu pentru bec GX53	100/10		
--------	----------	-----------------------	--------	--	--

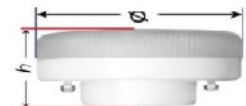

BECURI HALOGENE "ECO" PARA E27 230V

COD DABLEROM	COD PRODUCATOR	DENUMIRE	STICLA	PAC.	PRET €
bec halogen ECO para E27 230V - L:95mm D:55mm					
00-60518/T	14-7218	18W (echivalent 25W)	transparent	100/10	
00-60528/T	14-7228	28W (echivalent 40W)	transparent	100/10	
00-60542/T	14-7242	42W (echivalent 60W)	transparent	100/10	
00-60552/T	14-7252	52W (echivalent 75W)	transparent	100/10	
00-60570/T	14-7270	70W (echivalent 100W)	transparent	100/10	

00-60528/M	14-72281	28W (echivalent 40W)	mat	100/10	
00-60542/M	14-72421	42W (echivalent 60W)	mat	100/10	
00-60552/M	14-72521	52W (echivalent 75W)	mat	100/10	
00-60570/M	14-72701	70W (echivalent 100W)	mat	100/10	

00-60542/L	14-72420	42W (echivalent 60W)	laptos	100/10	
00-60552/L	14-72520	52W (echivalent 75W)	laptos	100/10	
00-60570/L	14-72700	70W (echivalent 100W)	laptos	100/10	



BECURI ECONOMICE PARA E27 240V

COD DABLEROM	COD PRODUCATOR	DENUMIRE	lumina	lumen	PAC.	PRET €
bec economic para E27 240V - lumina calda 2700k - 8000h						
00-735/11	14-5271116	11W- L:112mm D:55mm	calda	580	100/10	
00-735/15	14-5271156	15W- L:112mm D:55mm	calda	810	100/10	
00-735/20	14-5272206	20W- L:130mm D:65mm	calda	1170	80/10	

bec economic para E27 240V - lumina alba 4000k - 8000h						
00-736/11	14-5271111	11W- L:112mm D:55mm	alba	560	100/10	
00-736/15	14-5271151	15W- L:112mm D:55mm	alba	800	100/10	
00-736/20	14-5272201	20W- L:130mm D:65mm	alba	1155	80/10	



BECURI PARA CU POWER LED "MULTI CHIP" E27 230V

COD DABLEROM	COD PRODUCATOR	DENUMIRE	lumina	lumen	PAC.	PRET €
bec para cu power led "multi chip" E27 230V - lumina calda 3000k						
06-735/6	13-272600	6W - L:110mm D:60mm	calda	370	50/10	
06-735/8	13-272800	8W - L:110mm D:60mm	calda	560	50/10	

bec para cu power led "multi chip" E27 230V - lumina rece 5500k						
06-736/6	13-27260	6W - L:110mm D:60mm	rece	410	50/10	
06-736/8	13-27280	8W - L:110mm D:60mm	rece	620	50/10	



BECURI HALOGENE "ECO" R50 / R63 / R80 230V

COD DABLEROM	COD PRODUCATOR	DENUMIRE	STICLA	PAC.	PRET €
bec halogen ECO R50/R63/R80 230V					
00-60628/M	14-7450281	28W (ech.40W)- R50 -E14	mat	100/10	
00-60742/M	14-7463421	42W (ech.60W)- R63 -E27	mat	100/10	
00-60842/M	14-7480421	42W (ech.60W)- R80 -E27	mat	100/10	

**BECURI ECONOMICE R50 E14 240V**

COD DABLEROM	COD PRODUCATOR	DENUMIRE	lumina	lumen	PAC.	PRET €
bec economic R50 E14 240V - lumina calda 2700k - 8000h						
00-7506/7	14-5145076	7w - R50 L:85mm	calda	280	100/10	
00-750/cald	14-51450106	10w- R50 L:85mm	calda	450	100/10	

**bec economic R50 E14 240V - lumina rece 6400K - 8000h**

00-7501/7	14-5145071	7w - R50 L:85mm	rece	270	100/10	
00-750/rece	14-51450100	10w- R50 L:85mm	rece	440	100/10	

BECURI ECONOMICE R63 E27 240V

COD DABLEROM	COD PRODUCATOR	DENUMIRE	lumina	lumen	PAC.	PRET €
bec economic R63 E27 240V - lumina calda 2700k - 8000h						
00-7516/11	14-527630116	11w - R63 L:105mm	calda	520	100/10	
00-751/cald	14-52763136	13w - R63 L:105mm	calda	640	100/10	

**bec economic R63 E27 240V - lumina alba - 8000h**

00-7511/11	14-527630111	11w - R63 L:105mm	rece	500	100/10	
00-751/rece	14-52763137	13w - R63 L:105mm	alba	620	100/10	

BECURI ECONOMICE R80 E27 240V

COD DABLEROM	COD PRODUCATOR	DENUMIRE	lumina	lumen	PAC.	PRET €
bec economic R80 E27 240V - lumina calda 2700k - 8000h						
00-752/cald	14-52780156	15w - R80 L:116mm	calda	750	40/10	

**bec economic R80 E27 240V - lumina alba - 8000h**

00-752/alb	14-52780150	15w - R80 L:116mm	alba	730	40/10	
------------	-------------	-------------------	------	-----	-------	--

BECURI R50/R63 CU POWER LED "MULTI CHIP" 230V

COD DABLEROM	COD PRODUCATOR	DENUMIRE	lumina	lumen	PAC.	PRET €
bec R50/R63 cu power led "multi chip" 230V						
06-750/cald	13-143300	3W - R50 - L:85mm - E14	calda	190	50/10	
06-750/rece	13-14330	3W - R50 - L:85mm - E14	rece	210	50/10	
06-751/cald	13-274600	6W - R63 - L:105mm - E27	calda	320	50/10	
06-751/rece	13-27460	6W - R63 - L:105mm - E27	rece	350	50/10	

**BECURI ECONOMICE ANTIINSECTE R50 / R63 / R80 240V**

COD DABLEROM	COD PRODUCATOR	DENUMIRE	lumina	PAC.	PRET €
bec economic antiinsecte R50/R63/R80 240V - 8000h					
00-73150	14-51450	10W - R50 - E14 -L:84mm	galbena	100/10	
00-73163	14-52763	13W - R63 - E27 -L:107mm	galbena	100/10	
00-73180	14-52780153	15W - R80 - E27 -L:116mm	galbena	40/10	



februarie 2012

BECURI HALOGENE "ECO" SFERICE E14/E27 230V

COD DABLEROM	COD PRODUCATOR	DENUMIRE	STICLA	PAC.	PRET €
bec halogen ECO sferic E14 230V - L:80mm D:45mm					
00-60118/T	14-7118	18W (echivalent 25W)	transparent	100/10	
00-60128/T	14-7128	28W (echivalent 40W)	transparent	100/10	
00-60142/T	14-7142	42W (echivalent 60W)	transparent	100/10	
00-60118/M	14-71181	18W (echivalent 25W)	mat	100/10	
00-60128/M	14-71281	28W (echivalent 40W)	mat	100/10	
00-60142/M	14-71421	42W (echivalent 60W)	mat	100/10	
00-60128/L	14-712800	28W (echivalent 40W)	laptos	100/10	
00-60142/L	14-714200	42W (echivalent 60W)	laptos	100/10	

bec halogen ECO sferic E27 230V - L:80mm D:45mm					
00-60218/M	14-711181	18W (echivalent 25W)	mat	100/10	
00-60228/M	14-711281	28W (echivalent 40W)	mat	100/10	
00-60242/M	14-711421	42W (echivalent 60W)	mat	100/10	

BECURI ECONOMICE SFERICE E14/E27 240V

COD DABLEROM	COD PRODUCATOR	DENUMIRE	lumina	lumen	PAC.	PRET €
bec economic sferic E14 240V - 8000h						
00-753/cald	14-5144596	9W - L:85mm Ø:45mm	calda	435	100/10	
00-753/alb	14-5144591	9W - L:85mm Ø:45mm	alba	422	100/10	
00-753/rece	14-5144597	9W - L:85mm Ø:45mm	rece	410	100/10	

bec economic sferic E27 240V - 8000h						
00-754/cald	14-5274596	9W - L:85mm Ø:45mm	calda	435	100/10	
00-754/alb	14-5274591	9W - L:85mm Ø:45mm	alba	422	100/10	
00-754/rece	14-5274597	9W - L:85mm Ø:45mm	rece	410	100/10	

BECURI SFERICE CU POWER LED "MULTI CHIP" E14/E27 230V

bec sferic cu power led "multi chip" E14 230V						
06-753/cald	14-141300	3W - L:84mm Ø:45mm	calda	190	50/10	
06-753/rece	14-14130	3W - L:84mm Ø:45mm	rece	210	50/10	
bec sferic cu power led "multi chip" E27 230V						
06-754/cald	13-271400	4W - L:88mm Ø:45mm	calda	230	50/10	
06-754/rece	13-27140	4W - L:88mm Ø:45mm	rece	250	50/10	

BECURI ECONOMICE DIMABILE SFERICE E14 240V

bec economic sferic dimabil E14 230V						
00-753118/cald	14-514508116	11W - L:97mm Ø:45mm	calda	567	100/10	
00-753118/alb	14-514508111	11W - L:97mm Ø:45mm	alba	535	100/10	

BECURI SFERICE E27 CU 21LED 230V

bec sferic E27 cu 21LED 230V						
00-696/cald	14-602100	1.3W - L:110mm Ø:60mm	calda	59	100/10	
00-696/rece	14-60210	1.3W - L:110mm Ø:60mm	rece	63	100/10	
00-696/rosu	14-60212	1.3W - L:110mm Ø:60mm	rosie		100/10	
00-696/galben	14-60213	1.3W - L:110mm Ø:60mm	galbena		100/10	
00-696/albastru	14-60214	1.3W - L:110mm Ø:60mm	albastra		100/10	
00-696/verde	14-60215	1.3W - L:110mm Ø:60mm	verde		100/10	
00-696/RGB	14-60219	0.7W - L:110mm Ø:60mm	RGB (18LED)		100/10	



BECURI HALOGENE "ECO" GLOB E27 230V Ø95mm

COD DABLEROM	COD PRODUCATOR	DENUMIRE	STICLA	PAC.	PRET €
bec halogen ECO glob E27 230V - L:140mm Ø95mm					
00-60370/M	14-7195701	70W (echivalent 100W)	mat	60/6	
00-60370/L	14-7195700	70W (echivalent 100W)	laptos	60/6	

BECURI HALOGENE "ECO" GLOB E27 230V Ø120mm

COD DABLEROM	COD PRODUCATOR	DENUMIRE	STICLA	PAC.	PRET €
bec halogen ECO glob E27 230V - L:174mm Ø120mm					
00-60470/L	14-71105700	70W (echivalent 100W)	laptos	36/6	



BECURI ECONOMICE GLOB E27 240V - Ø95mm

COD DABLEROM	COD PRODUCATOR	DENUMIRE	lumina	lumen	PAC.	PRET €
bec economic glob E27 240V - Ø95mm - 8000h						
00-73823/cald	14-52795236	23W - L:130mm Ø:95mm	calda	1380	40/10	
00-738/cald	14-52795256	25W - L:130mm Ø:95mm	calda	1643	40/10	
00-73823/alb	14-52795231	23W - L:130mm Ø:95mm	alba	1320	40/10	
00-738/alb	14-52795251	25W - L:130mm Ø:95mm	alba	1597	40/10	
00-73823/rece	14-52795237	23W - L:130mm Ø:95mm	rece	1285	40/10	
00-738/rece	14-52795257	25W - L:130mm Ø:95mm	rece	1550	40/10	



BECURI ECONOMICE GLOB E27 240V - Ø105mm

COD DABLEROM	COD PRODUCATOR	DENUMIRE	lumina	lumen	PAC.	PRET €
bec economic glob E27 240V - Ø105mm - 8000h						
00-739/cald	14-52710286	28W - L:140mm Ø:105mm	calda	1855	20/10	
00-739/alb	14-52710281	28W - L:140mm Ø:105mm	alba	1803	20/10	
00-739/rece	14-52710287	28W - L:140mm Ø:105mm	rece	1750	20/10	



BECURI ECONOMICE GLOB E27 240V - Ø120mm

COD DABLEROM	COD PRODUCATOR	DENUMIRE	lumina	lumen	PAC.	PRET €
bec economic glob E27 240V - Ø120mm - 8000h						
00-740/cald	14-52712256	25W - L:165mm Ø:120mm	calda	1643	20/10	
00-741/cald	14-52712306	30W - L:170mm Ø:120mm	calda	2140	20/10	
00-74135/cald	14-52712356	35W - L:180mm Ø:120mm	calda	2390	20/10	



00-740/rece	14-52712257	25W - L:165mm Ø:120mm	rece	1550	20/10	
00-741/rece	14-52712307	30W - L:170mm Ø:120mm	rece	1900	20/10	
00-74135/rece	14-52712357	35W - L:180mm Ø:120mm	rece	2284	20/10	

BECURI ECONOMICE DIMABILE GLOB E27 240V Ø95mm

COD DABLEROM	COD PRODUCATOR	DENUMIRE	lumina	lumen	PAC.	PRET €
bec economic dimabil glob E27 240V - Ø95mm - 8000h						
00-738258/cald	14-5958256	25W - L:130mm Ø:95mm	calda	1643	100/10	
00-738258/alb	14-5958251	25W - L:130mm Ø:95mm	alba	1597	100/10	



BECURI ECONOMICE DIMABILE GLOB E27 240V Ø120mm

COD DABLEROM	COD PRODUCATOR	DENUMIRE	lumina	lumen	PAC.	PRET €
bec economic dimabil glob E27 240V - Ø120mm - 8000h						
00-741308/cald	14-51208306	30W - L:157mm Ø:120mm	calda	2014	100/10	
00-741308/alb	14-51208301	30W - L:157mm Ø:120mm	alba	1957	100/10	



BECURI HALOGENE LINIARE PENTRU PROIECTOARE 240V

COD DABLEROM	COD PRODUCATOR	DENUMIRE	STICLA	PAC.	PRET €
bec halogen liniar pentru proiectoare 240V - 1500h					
00-608	14-0100	100W - L:78mm	transparenta	500/50	
00-609	14-0150	150W - L:78mm	transparenta	500/50	
00-610	14-0200	200W - L:78mm	transparenta	500/50	
00-611	14-1100	100W - L:118mm	transparenta	500/50	
00-612	14-1150	150W - L:118mm	transparenta	500/50	
00-613	14-1200	200W - L:118mm	transparenta	500/50	
00-614	14-1300	300W - L:118mm	transparenta	500/50	
00-615	14-1500	500W - L:118mm	transparenta	500/50	
00-616	14-21000	1000W - L:189mm	transparenta	500/50	

**BECURI ECONOMICE PENTRU PROIECTOARE CU DULIE R7S 240V**

COD DABLEROM	COD PRODUCATOR	DENUMIRE	lumina	lumen	PAC.	PRET €
bec economic pt. proiectoare cu dulie R7S 240V - lumina alba 4100k - 8000h						
00-6071/10	14-78101	10W - L:78mm	alba	468	100/10	

00-6111/20	14-118201	20W - L:118mm	alba	1152	40/10	
------------	-----------	---------------	------	------	-------	--

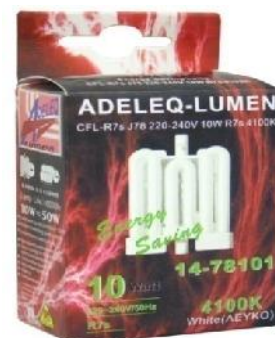
**BECURI ECONOMICE PL**

COD DABLEROM	COD PRODUCATOR	DENUMIRE	lumina	lumen	PAC.	PRET €
bec economic PLC 2pin pentru sistem de pornire electromagnetic - 8000h						
00-7176/26	14-266	26W-L:163mm D:34mm	calda	1800	100/25	
00-7171/13	14-131	13W-L:140mm D:34mm	alba	900	100/25	
00-7171/18	14-181	18W-L:153mm D:34mm	alba	1200	100/25	
00-7171/26	14-261	26W-L:163mm D:34mm	alba	1800	100/25	
00-7177/26	14-267	26W-L:163mm D:34mm	rece	1800	100/25	

bec economic PLC 4pin pentru sistem de pornire electronic - 8000h						
00-7186/26	14-2664	26W-L:163mm D:34mm	calda	1800	100/25	
00-7186/32	14-23264	32W-L:146mm D:48mm	calda	2400	100/25	
00-7181/13	14-1314	13W-L:140mm D:34mm	alba	900	100/25	
00-7181/18	14-1814	18W-L:153mm D:34mm	alba	1200	100/25	
00-7181/26	14-2614	26W-L:163mm D:34mm	alba	1800	100/25	
00-7181/32	14-23214	32W-L:146mm D:48mm	alba	2400	100/25	
00-7181/42	14-4214	42W-L:170mm D:48mm	alba	3200	100/25	
00-7187/26	14-2647	26W-L:163mm D:34mm	rece	1800	100/25	

**BECURI CU LED SMD PENTRU CORPURI E27 SI PL**

COD DABLEROM	COD PRODUCATOR	DENUMIRE	lumina	lumen	PAC.	PRET €
bec cu 60 led SMD 12W pentru corp E27 - 4000k						
00-7171/71	13-12271	E27 - L:168mm D:35mm	alba	900	10	
bec cu 60 led SMD 12W pentru corp PLC 2pini - 4000k						
00-7171/41	13-12241	PLC - L:161mm D:35mm	alba	900	10	

TUBURI FLOURESCENTE CIRCULARE

COD DABLEROM	COD PRODUCATOR	DENUMIRE	lumina	lumen	PAC.	PRET €
tub fluorescent circular - lumina rece 6500k - 8000h						
00-7167/22	14-00227	22W - Ø:210mm	rece	950	10	
00-7167/32	14-00327	32W - Ø:300mm	rece	1700	10	
00-7167/40	14-00407	40W - Ø:400mm	rece	2500	10	

**TUBURI CU LEDURI T8**

COD DABLEROM	COD PRODUCATOR	DENUMIRE	lumina	PAC.	PRET €
tub cu leduri SMD T8 - lumina alba 4000k					
19-0401/9	13-091	9W 144LED - L:600mm	alba	870	35/1
19-0401/18	13-181	18W 276LED - L:1200mm	alba	1660	35/1

**TUBURI DIMABILE CU LEDURI T8**

COD DABLEROM	COD PRODUCATOR	DENUMIRE	lumina	PAC.	PRET €
tub dimabile cu leduri SMD T8 - lumina alba 4000k					
19-04019/9	13-0919	9W 144LED - L:600mm	alba	870	35/1
19-04019/18	13-1819	18W 276LED - L:1200mm	alba	1660	35/1

**TUBURI FLOURESCENTE T5**

COD DABLEROM	COD PRODUCATOR	DENUMIRE	lumina	PAC.	PRET €
tub fluorescent T5 - lumina calda 2700k - 8000h					
19-040/4	14-0406	4W - L:135mm - Ø:16mm	calda	500/10	
19-040/6	14-0606	6W - L:210mm - Ø:16mm	calda	500/10	
19-040/8	14-0806	8W - L:286mm - Ø:16mm	calda	500/10	
19-040/13	14-0136	13W-L:515mm - Ø:16mm	calda	200/10	
19-040/21	14-0216	21W-L:845mm - Ø:16mm	calda	100/10	
19-040/28	14-0286	28W-L:1150mm - Ø:16mm	calda	100/10	
tub fluorescent T5 - lumina rece 6400k - 8000h					
19-041/4	14-0047	4W - L:135mm - Ø:16mm	rece	500/10	
19-041/6	14-0067	6W - L:210mm - Ø:16mm	rece	100/10	
19-041/8	14-0807	8W - L:286mm - Ø:16mm	rece	100/10	
19-041/13	14-0137	13W-L:515mm - Ø:16mm	rece	100/10	
19-041/21	14-0217	21W-L:845mm - Ø:16mm	rece	100/10	
19-041/28	14-0287	28W-L:1150mm - Ø:16mm	rece	100/10	

**TUBURI FLOURESCENTE BLACK LIGHT**

COD DABLEROM	COD PRODUCATOR	DENUMIRE	lumina	PAC.	PRET €
tub fluorescent T5 black light - 8000h					
00-715/4	14-041	4W - L:135mm - Ø:16mm	black light	500/10	
00-715/6	14-061	6W - L:210mm - Ø:16mm	black light	500/10	
00-715/8	14-0810	8W - L:286mm - Ø:16mm	black light	500/10	
00-715/13	14-0131	13W-L:515mm - Ø:16mm	black light	200/10	
00-715/21	14-0211	21W-L:845mm - Ø:16mm	black light	25	
tub fluorescent T8 black light - 8000h					
00-715/18	14-0181	18W-L:600mm - Ø:26mm	black light	25	
00-715/36	14-0361	36W-L:1200mm - Ø:26mm	black light	25	



BECURI DICHROICE GU10 240V

COD DABLEROM	COD PRODUCATOR	DENUMIRE	LUMINA	PAC.	PRET €
bec dichroic GU10 240V Ø35mm - unghi de lumina 38° - fara sticla - 1800h					
00-664	14-4025	25W - Ø:35mm	calda	200/10	
00-665	14-4035	35W - Ø:35mm	calda	200/10	
bec dichroic GU10 240V Ø50mm - unghi de lumina 38° - cu sticla - 1800h					
00-666	14-425	25W - Ø:50mm	calda	200/10	
00-667	14-435	35W - Ø:50mm	calda	200/10	
00-668	14-450	50W - Ø:50mm	calda	200/10	
00-669	14-475	75W - Ø:50mm	calda	200/10	
00-682	14-4503	50W - Ø:50mm	galbena	200/10	
00-683	14-4504	50W - Ø:50mm	albastra	200/10	
00-684	14-4505	50W - Ø:50mm	verde	200/10	



BECURI ECONOMICE GU10 240V

COD DABLEROM	COD PRODUCATOR	DENUMIRE	lumina	lumen	PAC.	PRET €
bec economic GU10 240V - Ø50mm - corp din aluminiu - lumina calda 2700k - 8000h						
00-7557/cald	14-41676	7W - L:51mm Ø:50mm	calda	280	120/10	
00-7569/cald	14-416906	9W - L:64mm Ø:50mm	calda	400	120/10	
00-75611/cald	14-416116	11W - L:75mm Ø:50mm	calda	520	120/10	
00-75613/cald	14-416136	13W - L:80mm Ø:50mm	calda	640	120/10	
bec economic GU10 240V - Ø50mm - corp din aluminiu - lumina alba 4000k - 8000h						
00-7557/alb	14-41671	7W - L:51mm Ø:50mm	alba	275	120/10	
00-7569/alb	14-416901	9W - L:64mm Ø:50mm	alba	390	120/10	
00-75611/alb	14-416111	11W - L:75mm Ø:50mm	alba	510	120/10	
00-75613/alb	14-416131	13W - L:80mm Ø:50mm	alba	630	120/10	
bec economic GU10 240V - Ø50mm - corp din aluminiu - lumina rece 6400k - 8000h						
00-7557/rece	14-41677	7W - L:51mm Ø:50mm	rece	270	120/10	
00-7569/rece	14-416907	9W - L:64mm Ø:50mm	rece	380	120/10	
00-75611/rece	14-416117	11W - L:75mm Ø:50mm	rece	500	120/10	
00-75613/rece	14-416137	13W - L:80mm Ø:50mm	rece	620	120/10	
becuri economice GU10 colorate 240V - Ø50mm - 8000h						
00-7557/rosu	14-41672	7W - L:51mm Ø:50mm	rosie	100/10		
00-7557/galben	14-41673	7W - L:51mm Ø:50mm	galbena	100/10		
00-7557/albastru	14-41674	7W - L:51mm Ø:50mm	albastra	100/10		
00-7557/verde	14-41675	7W - L:51mm Ø:50mm	verde	100/10		



BECURI ECONOMICE GU10 240V DIMABILE

COD DABLEROM	COD PRODUCATOR	DENUMIRE	lumina	lumen	PAC.	PRET €
bec economic GU10 240V - Ø50mm - lumina calda 2700k - 8000h - dimabil						
00-75698/cald	14-416896	9W - L:79mm Ø:50mm	calda	435	100/10	
00-756138/cald	14-4168136	13W - L:87mm Ø:50mm	calda	705	100/10	
bec economic GU10 240V - Ø50mm - lumina alba 4000k - 8000h - dimabil						
00-75698/alb	14-416891	9W - L:79mm Ø:50mm	alba	422	100/10	
00-756138/alb	14-4168131	13W - L:87mm Ø:50mm	alba	685	100/10	



BECURI GU10 CU LED 240V



95



COD DABLEROM	COD PRODUCATOR	DENUMIRE	lumina	lumen	PAC.	PRET €
bec GU10 cu 24LED 240V - Ø50mm - unghi de lumina 30°						
00-790	14-402000	1.4W - Ø:50mm - 24LED	caldă	80	200/10	
00-789	14-40200	1.4W - Ø:50mm - 24LED	rece	83	200/10	
00-791	14-40202	1.4W - Ø:50mm - 24LED	rosie		200/10	
00-792	14-40203	1.4W - Ø:50mm - 24LED	galbena		200/10	
00-793	14-40204	1.4W - Ø:50mm - 24LED	albastra		200/10	
00-794	14-40205	1.4W - Ø:50mm - 24LED	verde		200/10	
00-795	14-40209	0.8W - Ø:50mm - 24LED	RGB		200/10	
bec GU10 cu 36LED 240V - Ø50mm - unghi de lumina 30°						
00-7900	14-403600	1.9W - Ø:50mm - 36LED	caldă	97	200/10	
00-7890	14-40360	1.9W - Ø:50mm - 36LED	rece	103	200/10	



BECURI GU10 CU POWER LED 240V

COD DABLEROM	COD PRODUCATOR	DENUMIRE	lumina	lumen	PAC.	PRET €
bec GU10 cu 1 POWER LED 3W 240V - Ø50mm - unghi de lumina 30°						
06-804/cald	13-10133001	3W- L:55mm - 1LED	caldă	140	100/10	
06-804/rece	13-1013301	3W- L:55mm - 1LED	rece	150	100/10	
lentila pentru bec GU10 cu 1 POWER LED 3W 240V - Ø50mm						
06-800/50	13-501	unghi de deschidere 50°			10	



bec GU10 cu 3 POWER LED 4W 240V - Ø50mm - unghi de lumina 30°

06-814/cald	13-10143001	4W- L:53mm - 3LED	caldă	220	100/10	
06-814/rece	13-1014301	4W- L:53mm - 3LED	rece	250	100/10	
lentila pentru bec GU10 cu 3 POWER LED 4W 240V - Ø50mm						
06-810/15	13-153	unghi de deschidere 15°			200/50	
06-810/40	13-403	unghi de deschidere 40°			200/50	
06-810/50	13-503	unghi de deschidere 50°			200/50	



bec GU10 cu 1 POWER LED "CREE" 3W 240V - Ø50mm - unghi de lumina 30°

06-895/cald	13-10033001	3W- L:54mm - 1LED	caldă	125	100/10	
06-895/rece	13-1003301	3W- L:54mm - 1LED	rece	170	100/10	
06-895/rosu	13-100332	3W- L:67mm - 1LED	rosie		10/1	
06-895/portocaliu	13-100333	3W- L:67mm - 1LED	portocalie		10/1	
06-895/albastru	13-100334	3W- L:67mm - 1LED	albastra		10/1	
06-895/verde	13-100335	3W- L:67mm - 1LED	verde		10/1	



bec GU10 cu 3 POWER LED 6W 240V - Ø50mm - unghi de lumina 30°

06-824/cald	13-10153001	6W- L:71mm - 3LED	caldă	320	100/10	
06-824/rece	13-1015301	6W- L:71mm - 3LED	rece	360	100/10	



bec GU10 cu 3 POWER LED "CREE" 7W 240V - unghi de lumina 30° - dimabil cu dimmer digital

06-834/cald	13-100373009	7W- L:78mm - 3LED	caldă	335	100/10	
06-834/rece	13-10037309	7W- L:78mm - 3LED	rece	430	100/10	
lentila pentru bec GU10 cu 3 POWER LED 7W 240V - Ø50mm						
06-830/45	13-3045	unghi de deschidere 45°			10	
06-830/60	13-3060	unghi de deschidere 60°			10	



februarie 2012

BECURI DICHROICE MR16 12V

COD DABLEROM	COD PRODUCATOR	DENUMIRE	LUMINA	PAC.	PRET €
bec dichroic MR16 12V Ø50mm - unghi de lumina 38° - 2000h					
00-650	14-016201	20W - Ø:50mm	calda	200/10	
00-651	14-016351	35W - Ø:50mm	calda	200/10	
00-652	14-016501	50W - Ø:50mm	calda	200/10	
00-660	14-0165012	50W - Ø:50mm	rosie	200/10	
00-661	14-0165013	50W - Ø:50mm	galbena	200/10	
00-662	14-0165014	50W - Ø:50mm	albastra	200/10	
00-663	14-0165015	50W - Ø:50mm	verde	200/10	

**BECURI DICHROICE MR16 24V**

COD DABLEROM	COD PRODUCATOR	DENUMIRE	LUMINA	PAC.	PRET €
bec dichroic MR16 24V Ø50mm - unghi de lumina 38° - 2000h					
00-651/24	14-16353	35W - Ø:50mm	calda	200/10	
00-652/24	14-16503	50W - Ø:50mm	calda	200/10	

**BECURI DICHROICE MR16 42V**

COD DABLEROM	COD PRODUCATOR	DENUMIRE	LUMINA	PAC.	PRET €
bec dichroic MR16 42V Ø50mm - unghi de lumina 38° - 2000h					
00-650/42	14-16202	20W - Ø:50mm	calda	200/10	
00-651/42	14-16352	35W - Ø:50mm	calda	200/10	
00-652/42	14-16502	50W - Ø:50mm	calda	200/10	

**BECURI DICHROICE MR16 240V**

COD DABLEROM	COD PRODUCATOR	DENUMIRE	LUMINA	PAC.	PRET €
bec dichroic MR16 240V Ø50mm - unghi de lumina 38° - 2000h					
00-672	14-16025	25W - Ø:50mm	calda	200/10	
00-673	14-16035	35W - Ø:50mm	calda	200/10	
00-674	14-16050	50W - Ø:50mm	calda	200/10	
00-675	14-16075	75W - Ø:50mm	calda	200/10	
00-689	14-160502	50W - Ø:50mm	rosie	200/10	
00-690	14-160503	50W - Ø:50mm	galbena	200/10	
00-691	14-160504	50W - Ø:50mm	albastra	200/10	
00-692	14-160505	50W - Ø:50mm	verde	200/10	

**BECURI DICHROICE E27 240V**

COD DABLEROM	COD PRODUCATOR	DENUMIRE	LUMINA	PAC.	PRET €
bec dichroic E27 240V Ø50mm - unghi de lumina 38° - 2000h					
00-699/50	14-42750	50W - Ø:50mm	calda	200/10	

**BECURI E14/E27 CU LED 240V**

COD DABLEROM	COD PRODUCATOR	DENUMIRE	lumina	lumen	PAC.	PRET €
bec E14 cu 24LED 240V - Ø50mm - unghi de lumina 30°						
00-698/cald	14-143600	1.9W - L:76mm - 36LED	calda	85	100/10	
00-698/rece	14-14360	1.9W - L:76mm - 36LED	rece	90	100/10	
00-698/RGB	14-140209	0.8W - L:76mm - 24LED	RGB		200/10	
bec E27 cu 24LED 240V - Ø50mm - unghi de lumina 30°						
00-699/cald	14-273600	1.9W - L:77mm - 36LED	calda	85	100/10	
00-699/rece	14-27360	1.9W - L:77mm - 36LED	rece	90	100/10	
00-699/RGB	14-27279	0.8W - L:77mm - 27LED	RGB		100/10	



BECURI ECONOMICE MR16 240V

COD DABLEROM	COD PRODUCATOR	DENUMIRE	lumina	lumen	PAC.	PRET €
bec economic MR16 240V - Ø50mm - lumina calda 2700k - 8000h						
00-7607/cald	14-416760	7W - L:51mm Ø:50mm	calda	280	120/10	
00-7609/cald	14-4160960	9W - L:55mm Ø:50mm	calda	400	100/10	
bec economic MR16 240V - Ø50mm - lumina rece 6400k - 8000h						
00-7607/rece	14-416770	7W - L:51mm Ø:50mm	rece	270	100/10	
00-7609/rece	14-4160970	9W - L:55mm Ø:50mm	rece	380	100/10	
becuri economice MR16 colorate 240V - Ø50mm - 8000h						
00-7607/rosu	14-416720	7W - L:51mm Ø:50mm	rosie		100/10	
00-7607/galben	14-416730	7W - L:51mm Ø:50mm	galbena		100/10	
00-7607/albastru	14-416740	7W - L:51mm Ø:50mm	albastra		100/10	
00-7607/verde	14-416750	7W - L:51mm Ø:50mm	verde		100/10	



BECURI MR16 CU LED 12V DC

COD DABLEROM	COD PRODUCATOR	DENUMIRE	lumina	lumen	PAC.	PRET €
bec MR16 cu 24LED 12V DC - Ø50mm - unghi de lumina 30°						
00-780/12	14-0162000	1.4W - Ø:50mm - 24LED	calda	65	200/10	
00-779/12	14-016200	1.4W - Ø:50mm - 24LED	rece	70	200/10	
00-781/12	14-016202	1.4W - Ø:50mm - 24LED	rosie		200/10	
00-782/12	14-016203	1.4W - Ø:50mm - 24LED	galbena		200/10	
00-783/12	14-016204	1.4W - Ø:50mm - 24LED	albastra		200/10	
00-784/12	14-016205	1.4W - Ø:50mm - 24LED	verde		200/10	
00-785/12	14-016189	0.7W - Ø:50mm - 18LED	RGB		100/10	
bec MR16 cu 36LED 12V DC - Ø50mm - unghi de lumina 30°						
00-7800/12	14-0163600	1.9W - Ø:50mm - 36LED	calda	85	200/10	
00-7790/12	14-016360	1.9W - Ø:50mm - 36LED	rece	90	200/10	



BECURI MR16 CU LED 240V

COD DABLEROM	COD PRODUCATOR	DENUMIRE	lumina	lumen	PAC.	PRET €
bec MR16 cu 24LED 240V - Ø50mm - unghi de lumina 30°						
00-780/240	14-1602000	1.4W - Ø:50mm - 24LED	calda	80	200/10	
00-779/240	14-160200	1.4W - Ø:50mm - 24LED	rece	83	200/10	
00-781/240	14-160202	1.4W - Ø:50mm - 24LED	rosie		200/10	
00-782/240	14-160203	1.4W - Ø:50mm - 24LED	galbena		200/10	
00-783/240	14-160204	1.4W - Ø:50mm - 24LED	albastra		200/10	
00-784/240	14-160205	1.4W - Ø:50mm - 24LED	verde		200/10	
00-785/240	14-160209	0.8W - Ø:50mm - 24LED	RGB		200/10	
bec MR16 cu 30LED 240V - Ø50mm - unghi de lumina 30°						
00-7800/240	14-1603000	1.7W - Ø:50mm - 30LED	calda	85	200/10	
00-7790/240	14-160300	1.7W - Ø:50mm - 30LED	rece	90	200/10	



BECURI MR16 CU POWER LED 12V AC/DC

COD DABLEROM	COD PRODUCATOR	DENUMIRE	lumina	lumen	PAC.	PRET €
bec MR16 cu 1 POWER LED 3W 12V AC/DC - Ø50mm - unghi de lumina 30°						
06-802/cald	13-16033001	3W- L:42mm - 1LED	cald	150	100/10	
06-802/rece	13-1603301	3W- L:42mm - 1LED	rece	160	100/10	
lentila pentru bec GU10 cu 1 POWER LED 3W 240V - Ø50mm						
06-800/50	13-501	unghi de deschidere 50°			10	



bec MR16 cu 3 POWER LED 4W 12V AC/DC - Ø50mm - unghi de lumina 30°						
06-812/cald	13-16043001	4W- L:42mm - 3LED	cald	220	100/10	
06-812/rece	13-1604301	4W- L:42mm - 3LED	rece	250	100/10	
lentila pentru bec GU10 cu 3 POWER LED 4W 240V - Ø50mm						
06-810/15	13-153	unghi de deschidere 15°			200/50	
06-810/40	13-403	unghi de deschidere 40°			200/50	
06-810/50	13-503	unghi de deschidere 50°			200/50	



bec MR16 cu 1 POWER LED "CREE" 3W 12V AC/DC - Ø50mm - unghi de lumina 30°						
06-891/cald	13-1633009	3W- L:43mm - 1LED	cald	125	100/10	
06-891/rece	13-163309	3W- L:43mm - 1LED	rece	170	100/10	
06-891/rosu	13-16332	3W- L:43mm - 1LED	rosie		10/1	
06-891/portocaliu	13-16333	3W- L:43mm - 1LED	portocalie		10/1	
06-891/albastru	13-16334	3W- L:43mm - 1LED	albastra		10/1	
06-891/verde	13-16335	3W- L:43mm - 1LED	verde		10/1	



bec MR16 cu 3 POWER LED 6W 12V AC/DC - Ø50mm - unghi de lumina 30°						
06-822/cald	13-16063001	6W- L:61mm - 3LED	cald	350	100/10	
06-822/rece	13-1606301	6W- L:61mm - 3LED	rece	360	100/10	



bec MR16 cu 3 POWER LED 5W 12VAC/DC- unghi lumina 25° - dimabil cu dimmer digital						
06-832/cald	13-1652500	5W- L:44mm - 3LED	cald	310	10/1	
06-832/rece	13-165250	5W- L:44mm - 3LED	rece	380	10/1	



BECURI MR16 CU POWER LED 240V

COD DABLEROM	COD PRODUCATOR	DENUMIRE	lumina	lumen	PAC.	PRET €
bec MR16 cu 1 POWER LED "CREE" 3W 240V - Ø50mm - unghi de lumina 30°						
06-893/cald	13-1603300	3W- L:60mm - 1LED	cald	105	10/1	
06-893/rece	13-160330	3W- L:60mm - 1LED	rece	137	10/1	
06-893/rosu	13-160332	3W- L:60mm - 1LED	rosie		10/1	
06-893/portocaliu	13-160333	3W- L:60mm - 1LED	portocalie		10/1	
06-893/albastru	13-160334	3W- L:60mm - 1LED	albastra		10/1	
06-893/verde	13-160335	3W- L:60mm - 1LED	verde		10/1	



BECURI DICHROICE MR11 12V

COD DABLEROM	COD PRODUCATOR	DENUMIRE	LUMINA	PAC.	PRET €
bec dichroic MR11 12V Ø35mm - unghi de lumina 38° - 2000h					
00-645	14-011201	20W - Ø:35mm	calda	200/10	
00-646	14-011351	35W - Ø:35mm	calda	200/10	
00-656	14-0112012	20W - Ø:35mm	rosie	200/10	
00-657	14-0112013	20W - Ø:35mm	galbena	200/10	
00-658	14-0112014	20W - Ø:35mm	albastra	200/10	
00-659	14-0112015	20W - Ø:35mm	verde	200/10	

**BECURI DICHROICE MR11 240V**

COD DABLEROM	COD PRODUCATOR	DENUMIRE	LUMINA	PAC.	PRET €
bec dichroic MR11 240V Ø35mm - unghi de lumina 38° - 2000h					
00-670	14-11025	25W - Ø:35mm	calda	200/10	
00-671	14-11035	35W - Ø:35mm	calda	200/10	

**BECURI MR11 CU LED 12V DC**

COD DABLEROM	COD PRODUCATOR	DENUMIRE	lumina	lumen	PAC.	PRET €
bec MR11 cu 15LED 12V DC - Ø35mm - unghi de lumina 30°						
00-770/12	14-011900	0.8W - Ø:35mm - 15LED	calda	40	200/10	
00-769/12	14-01190	0.8W - Ø:35mm - 15LED	rece	45	200/10	
00-771/12	14-01192	0.8W - Ø:35mm - 15LED	rosie		200/10	
00-772/12	14-01193	0.8W - Ø:35mm - 15LED	galbena		200/10	
00-773/12	14-01194	0.8W - Ø:35mm - 15LED	albastra		200/10	
00-774/12	14-01195	0.8W - Ø:35mm - 15LED	verde		200/10	

**BECURI MR11 CU LED 240V**

COD DABLEROM	COD PRODUCATOR	DENUMIRE	lumina	lumen	PAC.	PRET €
bec MR11 cu 15LED 240V - Ø35mm - unghi de lumina 30°						
00-770/240	14-110900	0.8W - Ø:35mm - 15LED	calda	48	200/10	
00-769/240	14-11090	0.8W - Ø:35mm - 15LED	rece	50	200/10	
00-771/240	14-11092	0.8W - Ø:35mm - 15LED	rosie		200/10	
00-772/240	14-11093	0.8W - Ø:35mm - 15LED	galbena		200/10	
00-773/240	14-11094	0.8W - Ø:35mm - 15LED	albastra		200/10	
00-774/240	14-11095	0.8W - Ø:35mm - 15LED	verde		200/10	

**BECURI MR11 CU POWER LED 12V AC/DC**

COD DABLEROM	COD PRODUCATOR	DENUMIRE	lumina	lumen	PAC.	PRET €
bec MR11 cu 1 POWER LED 1.5W 12V AC/DC - Ø35mm - unghi de lumina 30°						
06-889/cald	13-111200	1.5W- L:30mm - 1LED	calda	100	100/10	
06-889/rece	13-11120	1.5W- L:30mm - 1LED	rece	110	100/10	



bec MR11 cu 1 POWER LED "CREE" 1W 12V AC/DC - Ø35mm - unghi de lumina 30°						
06-889/rosu	13-11312	1W- L:35mm - 1LED	rosie	10/1		
06-889/portocaliu	13-11313	1W- L:35mm - 1LED	portocalie	10/1		
06-889/albastru	13-11314	1W- L:35mm - 1LED	albastra	10/1		
06-889/verde	13-11315	1W- L:35mm - 1LED	verde	10/1		



BECURI BULB HALOGEN 12V JC/G4

COD DABLEROM	COD PRODUCATOR	DENUMIRE	dulie	PAC.	PRET €
bec bulb halogen JC/G4 12V - 2000h					
00-625	14-00005	5W	JC/G4	50	
00-626	14-00010	10W	JC/G4	50	
00-627	14-00020	20W	JC/G4	50	
00-628	14-00035	35W	JC/G4	50	

BECURI BULB HALOGEN 240V JCD/G4

COD DABLEROM	COD PRODUCATOR	DENUMIRE	dulie	PAC.	PRET €
bec bulb halogen JCD/G4 240V - 2000h					
00-639	14-000252	25W	JCD/G4	50	

BECURI BULB HALOGEN 12V JC/G6.35

COD DABLEROM	COD PRODUCATOR	DENUMIRE	dulie	PAC.	PRET €
bec bulb halogen JC/G6.35 12V - 2000h					
00-629	14-0020	20W	JC/G6.35	50	
00-630	14-0035	35W	JC/G6.35	50	
00-631	14-0050	50W	JC/G6.35	50	

BECURI BULB HALOGEN 240V JC/G6.35

COD DABLEROM	COD PRODUCATOR	DENUMIRE	dulie	PAC.	PRET €
bec bulb halogen JC/G6.35 240V - 2000h					
00-640	14-00352	35W	JC/G6.35	50	
00-641	14-00502	50W	JC/G6.35	50	
00-642/100	14-001002	100W	JC/G6.35	50	

BECURI BULB CU LED 12V AC/DC G4

COD DABLEROM	COD PRODUCATOR	DENUMIRE	lumina	lumen	PAC.	PRET €
bec bulb G4 cu LED 12V AC/DC - Ø10mm - unghi de lumina 45°						
00-693/cald	14-1000	0.5W - Ø:10mm - L:23mm	caldă	9	100/10	
00-693/rece	14-100	0.5W - Ø:10mm - L:23mm	rece	10	100/10	
00-693/rosu	14-102	0.5W - Ø:10mm - L:23mm	rosie		100/10	
00-693/galben	14-1033	0.5W - Ø:10mm - L:23mm	galbena		100/10	
00-693/portocaliu	14-103	0.5W - Ø:10mm - L:23mm	portocalie		100/10	
00-693/albastru	14-104	0.5W - Ø:10mm - L:23mm	albastra		100/10	

BECURI CU LED 12V AC/DC G4

COD DABLEROM	COD PRODUCATOR	DENUMIRE	lumina	lumen	PAC.	PRET €
bec bulb G4 cu 9LED SMD 12V AC/DC - Ø29mm h:5mm - unghi de lumina 120°						
00-6930/cald	14-2000	2.5W - Ø:29mm - h:5mm	caldă	81	100/10	
00-6930/rece	14-200	2.5W - Ø:29mm - h:5mm	rece	85	100/10	

BECURI BULB CU LED 240V G4

COD DABLEROM	COD PRODUCATOR	DENUMIRE	lumina	lumen	PAC.	PRET €
bec bulb G4 cu LED 240V - Ø10mm - unghi de lumina 90°						
00-6932/cald	14-12300	0.5W - Ø:10mm - L:23mm	caldă	9	100/10	
00-6932/rece	14-1230	0.5W - Ø:10mm - L:23mm	rece	10	100/10	
00-6932/rosu	14-1232	0.5W - Ø:10mm - L:23mm	rosie		100/10	
00-6932/galben	14-1233	0.5W - Ø:10mm - L:23mm	galbena		100/10	
00-6932/albastru	14-1234	0.5W - Ø:10mm - L:23mm	albastra		100/10	

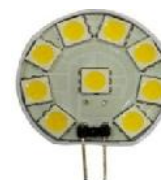

BECURI BULB HALOGEN 240V G9/JCD

COD DABLEROM	COD PRODUCATOR	DENUMIRE	sticla	PAC.	PRET €
bec bulb halogen G9/JCD 240V - 1800h					
00-619	14-00253	25W	transparenta	50	
00-620	14-002531	25W	mat	50	
00-621	14-00403	40W	transparenta	50	
00-622	14-004031	40W	mat	50	
00-623	14-00603	60W	transparenta	50	
00-624	14-006031	60W	mat	50	



BECURI ECONOMICE 240V G9

COD DABLEROM	COD PRODUCATOR	DENUMIRE	lumina	lumen	PAC.	PRET €
bec economic G9 240V - lumina calda 2700k - 8000h						
00-786/7	14-5976	7W - L:70mm D:32mm	calda	310	100/10	
00-786/9	14-5996	9W - L:81mm D:32mm	calda	450	100/10	
00-786/11	14-59116	11W - L:83mm D:32mm	calda	580	100/10	
bec economic G9 240V - lumina alba 4000k - 8000h						
00-7861/7	14-5971	7W - L:70mm D:32mm	alba	305	100/10	
00-7861/9	14-5991	9W - L:81mm D:32mm	alba	430	100/10	
00-7861/11	14-59111	11W - L:83mm D:32mm	alba	550	100/10	
bec economic G9 240V - lumina rece 6400k - 8000h						
00-787/7	14-5977	7W - L:70mm D:32mm	rece	300	100/10	
00-787/9	14-5997	9W - L:81mm D:32mm	rece	410	100/10	
00-787/11	14-59117	11W - L:83mm D:32mm	rece	535	100/10	



BECURI HALOGENE AR111 12V

COD DABLEROM	COD PRODUCATOR	DENUMIRE	PAC.	PRET €
bec halogen AR111 12V - 24° - 2000h				
00-604	14-11150	50W - Ø:110mm	60/10	



BECURI ECONOMICE AR111 CU DULIE GU10 240V

COD DABLEROM	COD PRODUCATOR	DENUMIRE	lumina	lumen	PAC.	PRET €
bec economic AR111 cu dulie GU10 240V - lumina alba 4000k - 8000h						
00-6041/18	14-418181	18W - L:75mm Ø:110mm	alba	720	48/6	



BECURI AR111 CU 6 POWER LED 12V AC

COD DABLEROM	COD PRODUCATOR	DENUMIRE	lumina	lumen	PAC.	PRET €
bec AR111 cu 6 POWER LED 12W - 12V AC - unghi de lumina 30° - dimabil						
00-604112/cald	13-111123008	12W - L:58mm Ø:110mm	calda	620	10/1	
00-604112/rece	13-11112308	12W - L:58mm Ø:110mm	rece	640	10/1	
lentile pentru bec AR111 cu 6 POWER LED						
00-604112/15	13-153	unghi de deschidere 15° - set 3 lentile			50/1	
00-604112/30	13-303	unghi de deschidere 30° - set 3 lentile			50/1	
00-604112/40	13-403	unghi de deschidere 40° - set 3 lentile			50/1	
00-604112/50	13-503	unghi de deschidere 50° - set 3 lentile			50/1	
00-604112/90	13-903	unghi de deschidere 90° - set 3 lentile			50/1	



BECURI PENTRU CUPTOR/FRIGIDER E14

COD DABLEROM	COD PRODUCATOR	DENUMIRE	sticla	PAC.	PRET €
bec pentru cuptor 300° - 15W - E14					
52-070	52-070	15W -E14-pentru cuptor	transparenta	10	

bec pentru frigider - 15W - E14					
52-071	52-071	15W -E14 -pentru frigider	transparenta	10	

**BECURI BULB 230V E14**

COD DABLEROM	COD PRODUCATOR	DENUMIRE	sticla	PAC.	PRET €
bec bulb 3W - E14					
52-050/transp	52-050/t	3W - E14	transparenta	25	
52-050/mat	52-050/m	3W - E14	mat	25	
52-050/rosu	52-050/r	3W - E14	rosie	25	
52-050/galben	52-050/g	3W - E14	galbena	25	
52-050/portocaliu	52-050/p	3W - E14	portocalie	25	
52-050/albastru	52-050/a	3W - E14	albastra	25	
52-050/verde	52-050/v	3W - E14	verde	25	

**BECURI BULB CU LED 230V E14**

COD DABLEROM	COD PRODUCATOR	DENUMIRE	lumina	PAC.	PRET €
bec bulb E14 cu 1LED SMD 230V - Ø15mm L:60mm					
00-694/cald	14-11400	0.5W - Ø:15mm - L:60mm	caldă	200/20	
00-694/rece	14-1140	0.5W - Ø:15mm - L:60mm	rece	200/20	
00-694/rosu	14-1142	0.5W - Ø:15mm - L:60mm	rosie	200/20	
00-694/galben	14-11433	0.5W - Ø:15mm - L:60mm	galbena	200/20	
00-694/portocaliu	14-1143	0.5W - Ø:15mm - L:60mm	portocalie	200/20	
00-694/albastru	14-1144	0.5W - Ø:15mm - L:60mm	albastra	200/20	
00-694/verde	14-1145	0.5W - Ø:15mm - L:60mm	verde	200/20	

**BECURI BULB CU LED 230V E27**

COD DABLEROM	COD PRODUCATOR	DENUMIRE	lumina	PAC.	PRET €
bec bulb E27 cu 1LED SMD 230V - Ø26mm L:60mm					
00-695/cald	14-12700	0.5W - Ø:26mm - L:60mm	caldă	100/10	
00-695/rece	14-1270	0.5W - Ø:26mm - L:60mm	rece	100/10	



BECURI CU IODURA METALICA (HQI) R7S

COD DABLEROM	COD PRODUCATOR	DENUMIRE	lumina	lumen	PAC.	PRET €
bec cu iodura metalica HQI dulie R7S - 8000h						
00-7116	14-60706	70W - R7S	calda	5600	100/10	
00-7117	14-60707	70W - R7S	rece	5200	100/10	

00-7126	14-61506	150W - R7S	calda	12000	100/10	
00-7127	14-61507	150W - R7S	rece	11000	100/10	

BECURI CU IODURA METALICA (HQI) G12

COD DABLEROM	COD PRODUCATOR	DENUMIRE	lumina	lumen	PAC.	PRET €
bec cu iodura metalica HQI dulie G12 - 8000h						
00-7096/70	14-6120706	70W - G12	calda	5600	100/10	
00-7097/70	14-6120707	70W - G12	rece	5200	100/10	

00-7096/150	14-6121506	150W - G12	calda	12000	100/10	
00-7097/150	14-6121507	150W - G12	rece	11000	100/10	

BECURI CU IODURA METALICA (HQI) E40

COD DABLEROM	COD PRODUCATOR	DENUMIRE	lumina	lumen	PAC.	PRET €
bec cu iodura metalica HQI dulie E40 - 10000h						
00-7137	14-62507	250W - E40	rece	20800	50/10	

00-7146	14-64006	400W - E40	alba	36000	50/10	
00-7147	14-64007	400W - E40	rece	28000	50/10	

BECURI CU AUTOAPRINDERE

COD DABLEROM	COD PRODUCATOR	DENUMIRE	dulie	lumen	PAC.	PRET €
bec cu autoaprindere - 6000h						
00-700	14-31600	160W	E27	2600	25	
00-701	14-32501	250W	E27	5000	20	
00-702	14-32500	250W	E40	5000	20	

BECURI CU VAPORI DE MERCUR

COD DABLEROM	COD PRODUCATOR	DENUMIRE	dulie	lumen	PAC.	PRET €
bec cu vapori de mercur - 12000h						
00-704	14-11250	125W	E27	6000	25	
00-705	14-12500	250W	E40	12500	20	
00-706	14-14000	400W	E40	22000	10	

BECURI CU VAPORI DE SODIU

COD DABLEROM	COD PRODUCATOR	DENUMIRE	dulie	lumen	PAC.	PRET €
bec cu vapori de sodiu - 24000h						
00-707	14-21500	150W	E40	14000	12	
00-708	14-22500	250W	E40	25000	12	



DULII E14

COD DABLEROM	COD PRODUCATOR	DENUMIRE	PAC.	PRET €
dulie E14 portelan				
00-854/14	16-09	E14 portelan mini M10 (1/8")	600/20	
00-864	16-42	E14 portelan spot	600/50	
00-865	16-44	E14 portelan cu lama M10 (1/8")	600/20	



dulie E14 bachelita				
00-855/alb	16-1000	E14 termoplastic M10(1/8") - alb	400/20	
00-855/negru	16-101	E14 bachelita M10(1/8") - negru	400/20	
00-862/alb	16-1010	E14 bachelita cu filet M10(1/8") - alb	600/20	
00-852/alb	16-10100	inel bachelita pentru 00-862/alb	40	
00-862/negru	16-1011	E14 bachelita cu filet M10(1/8") - negru	400/20	
00-852/negru	16-1012	inel bachelita pentru 00-862/negru	20	

**DULII E27**

COD DABLEROM	COD PRODUCATOR	DENUMIRE	PAC.	PRET €
dulie E27 portelan				
00-854/27	16-11	E27 portelan mini M10(1/8")	300/30	
00-857/27	16-12	E27 portelan butoi M10(1/8")	200/20	
00-858	16-25	E27 portelan spot	400/50	
00-860	16-27	E27 portelan cu lama la 90° in jos	400/50	
00-861	16-28	E27 portelan cu lama la 90° in sus	400/50	
00-866	16-60	E27 portelan plafon	200/20	



dulie E27 bachelita				
00-856/alb	16-1100	E27 termoplastic M10(1/8") - alb	200/20	
00-856/negru	16-111	E27 bachelita M10(1/8") - negru	200/20	
00-863/alb	16-1110	E27 bachelita cu filet M10(1/8") - alb	400/20	
00-853/alb	16-11100	inel bachelita pentru 00-863/alb	40	
00-863/negru	16-1111	E27 bachelita cu filet M10(1/8") - negru	200/20	
00-853/negru	16-1112	inel bachelita pentru 00-863/negru	20	

**DULII E40**

COD DABLEROM	COD PRODUCATOR	DENUMIRE	PAC.	PRET €
dulie E40 portelan				
00-857/40	16-13	E40 portelan butoi (5/8")	60/10	
00-867	16-61	E40 portelan cu lama	80/10	
00-868	16-62	E40 portelan plafon	90/10	



ADAPTOR DULIE

COD DABLEROM	COD PRODUCATOR	DENUMIRE	PAC.	PRET €
adaptor dulie plastic				
00-850/0914	16-0914	de la G9 la E14	10	
00-850/1014	16-01014	de la GU10 la E14	10	
00-850/1027	16-01027	de la GU10 la E27	10	
00-850/1410	16-01410	de la E14 la GU10	10	
00-850/1427	16-01427	de la E14 la E27	10	
00-850/2710	16-02710	de la E27 la GU10	10	
00-850/2714	16-02714	de la E27 la E14	10	
00-850/4027	16-04027	de la E40 la E27	10	

**DULII DICHROICE**

COD DABLEROM	COD PRODUCATOR	DENUMIRE	PAC.	PRET €
dulie dichroic portelan				
00-869	16-70	portelan cu cablu siliconic 15cm	100/20	
00-872	16-72	portelan cu surub fara cablu	100	

**DULII GU10**

COD DABLEROM	COD PRODUCATOR	DENUMIRE	PAC.	PRET €
dulie GU10 portelan				
00-873	16-73	portelan GU10(tip starter)cu cablu 15cm	500/10	

**DULII G9/JCD**

COD DABLEROM	COD PRODUCATOR	DENUMIRE	PAC.	PRET €
dulie G9 portelan				
00-874	16-74	portelan G9/JCD cu surub - M10(1/8")	100	

**DULII HALOGEN**

COD DABLEROM	COD PRODUCATOR	DENUMIRE	PAC.	PRET €
dulie halogen portelan				
00-824	4-7150	150W - 78mm	10	
00-825	4-7500	500W - 118mm	10	
00-826	4-7750	1000W - 189mm	10	
00-827	4-71000	1000W/1500W - perechi	5	
00-828	4-715001	1500W - 254mm	10	

**DULII HQI**

COD DABLEROM	COD PRODUCATOR	DENUMIRE	PAC.	PRET €
dulie HQI portelan				
00-829	3-70700	70W - R7S	10	
00-830	3-71500	150W - R7S	10	

**DULII NEON & SOCLU STARTER**

COD DABLEROM	COD PRODUCATOR	DENUMIRE	PAC.	PRET €
dulie neon & soclu starter				
48-000	48000	dulie neon simplu	100	
48-001	48001	dulie neon + soclu starter	100	
48-002	48002	soclu starter	100	



SISTEME DE PORNIRE ELECTROMAGNETICE PT. BECURI PL

COD DABLEROM	COD PRODUCATOR	DENUMIRE	PAC.	PRET €
sisteme de pornire electromagnetice cu carcasa din metal pentru becuri PLC				
00-090	3-5013	2x13W - L:157mm W:93mm h:37mm	10	
00-091	3-5018	2x18W - L:157mm W:93mm h:37mm	10	
00-092	3-5026	2x26W - L:178mm W:93mm h:37mm	10	

sisteme de pornire electromagnetice cu carcasa metalica pentru becuri PLC cu condensator 9mf

00-093	3-51130	2x13W - L:157mm W:93mm h:37mm	10	
00-094	3-51180	2x18W - L:157mm W:93mm h:37mm	10	
00-095	3-51260	2x26W - L:178mm W:93mm h:37mm	10	

**SISTEME DE PORNIRE ELECTRONICE PT. BECURI PL**

COD DABLEROM	COD PRODUCATOR	DENUMIRE	PAC.	PRET €
sisteme de pornire electronice pentru becuri PLC - L:93mm W:67mm h:30mm cu protectia la: scoaterea tubului , montarea tubului invers, arderea tubului, supratensiune				
00-096/13	3-50131	2x13W $\lambda(\cos\phi)=0.95$	100/1	
00-096/18	3-50181	2x18W $\lambda(\cos\phi)=0.95$	40/5	
00-096/26	3-50261	2x26W $\lambda(\cos\phi)=0.98$	40/5	
00-096/32	3-50321	2x32W $\lambda(\cos\phi)=0.98$	40/5	
00-096/42	3-50421	2x42W $\lambda(\cos\phi)=0.98$	40/5	

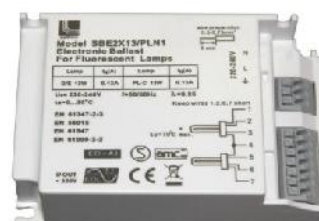
**SISTEME DE PORNIRE ELECTROMAGNETICE PT. BECURI HQI**

COD DABLEROM	COD PRODUCATOR	DENUMIRE	PAC.	PRET €
sisteme de pornire electromagnetice cu carcasa din metal pentru becuri HQI				
00-150	3-870	70W - L:200mm W:130mm h:70mm	6	
00-151	3-8150	150w - L:200mm W:130mm h:70mm	6	

**SISTEME DE PORNIRE ELECTROMAGNETICE PT. BECURI HQI**

COD DABLEROM	COD PRODUCATOR	DENUMIRE	PAC.	PRET €
sisteme de pornire electronice pentru becuri HQI $\lambda(\cos\phi)=0.98$				
00-150/7	3-50070	70w - L:110mm W:75mm h:30mm	20/2	

**IGNITERE PENTRU BECURI HQI & SODIUM**

COD DABLEROM	COD PRODUCATOR	DENUMIRE	PAC.	PRET €
igniter pentru becuri HQI & SODIUM 230V				
00-820	3-6400	de la 70W pana la 400W	100/10	
00-821	3-61000	de la 250W pana la 1000W	50/5	



TRANSFORMATOARE ELECTROMAGNETICE 230V/12V

107

COD DABLEROM	COD PRODUCATOR	DENUMIRE	PAC.	PRET €
transformator electromagnetic tip balast 230V/12V				
00-805	3-51250	50W - 230V/12V	20	
00-806	3-512105	105W - 230V/12V	20	



TRANSFORMATOR ELECTRONIC ROTUND DIMABIL 230V/12VAC

COD DABLEROM	COD PRODUCATOR	DENUMIRE	PAC.	PRET €
transformator rotund electronic dimabil 230V/12V AC $\lambda(\cos\phi)=0.99$ cu protectia la: supratensiune, supra putere, supra incalzire				
00-807	3-512350	min.10W-max.35W \varnothing :55mm h:19mm	100/10	
00-809/70	3-512700	min.20W-max.70W \varnothing :56mm h:22mm	100/10	
00-809/105	3-5121050	min.35W-max.105W \varnothing :87mm h:22mm	20/10	
00-809/160	3-5121600	min.50W-max.160W \varnothing :102mm h:39mm	20/10	
00-809/250	3-5122500	min.50W-max.250W \varnothing :128mm h:44mm	30/10	



TRANSFORMATOR ELECTRONIC SUPER MINI 230V/12VAC

COD DABLEROM	COD PRODUCATOR	DENUMIRE	PAC.	PRET €
transformator super mini electronic 230V/12V AC $\lambda(\cos\phi)=0.99$				
00-808/50	3-512500	min.20W-max.50W L:60mm W:31mm h:18mm	100/1	



TRANSFORMATOARE ELECTRONICE DIMABILE 230V/12VAC

COD DABLEROM	COD PRODUCATOR	DENUMIRE	PAC.	PRET €
transformator electronic dimabil 230V/12V AC $\lambda(\cos\phi)=0.99$ cu protectia la: supratensiune, supra putere, supra incalzire				
00-808/60	3-512602	min.10W-max.60W L:119mm W:30mm h:20mm	100/10	
00-808/105	3-5121052	min.35W-max.105W L:122mm W:39mm h:18mm	100/10	
00-808/150	3-5121502	min.35W-max.150W L:133mm W:44mm h:24mm	10	
00-808/210	3-5122102	min.50W-max.210W L:214mm W:47mm h:44mm	50/10	



TRANSFORMATOR ELECTRONIC DIMABIL 230V/12VAC IP68

COD DABLEROM	COD PRODUCATOR	DENUMIRE	PAC.	PRET €
transformator electronic dimabil 230V/12V AC $\lambda(\cos\phi)=0.99$ - IP68 - cu cablu 2m(in)+2m(out) cu protectia la: supratensiune, supra putere, supra incalzire				
00-819	3-51210568	min.35W-max.105W L:183mm W:90mm h:45mm	20	



februarie 2012

BALAST ELECTROMAGNETIC PENTRU TUBURI FLOURESCENTE T8

COD DABLEROM	COD PRODUCATOR	DENUMIRE	PAC.	PRET €
balast electromagnetic pentru tuburi fluorescente T8				
00-802	3-5180	18W T8	40	
00-803	3-5360	36W T8	40	
00-804	3-5580	58W T8	20	

**BALAST ELECTRONIC PENTRU TUBURI FLOURESCENTE T8**

COD DABLEROM	COD PRODUCATOR	DENUMIRE	PAC.	PRET €
balast electronic pentru tuburi fluorescente T8 - 240V AC - $\lambda(\cos\phi)=0.98$ cu protectia la: supratensiune, supra putere				
00-845	3-5181	1x18W - 235x30x28mm	50/1	
00-845/2	3-52181	1x36W - 235x30x28mm (sau 2x18W)	70/5	
00-847	3-5581	1x58W - 278x30x25mm	20/5	
00-845/2	3-52181	2x18W - 235x30x28mm (sau 1x36W)	70/5	
00-846/2	3-52361	2x36W - 295x30x28mm	20/5	
00-847/2	3-50581	2x58W - 365x30x30mm	20/5	
00-845/4	3-54181	4x18W - 305x38x28mm	50/1	

**BALAST ELECTRONIC PENTRU TUBURI FLOURESCENTE T5**

COD DABLEROM	COD PRODUCATOR	DENUMIRE	PAC.	PRET €
balast electronic pentru tuburile fluorescent T5 - 240V AC - $\lambda(\cos\phi)=0.98$ cu protectia la: supratensiune, supra putere				
00-840/14	3-5114	1x14W - 210x30x21mm	70/5	
00-840/21	3-5121	1x21W - 290x30x30mm	20/5	
00-840/24	3-5124	1x24W - 290x30x30mm	20/5	
00-840/28	3-5128	1x28W - 290x30x30mm	40/5	
00-840/35	3-5135	1x35W - 358x30x30mm	20/5	
00-840/54	3-5154	1x54W - 430x20x20mm	40/2	
00-840/80	3-580	1x80W - 358x30x30mm	20/5	
00-841/14	3-5214	2x14W - 290x37x30mm	50/1	
00-841/21	3-5221	2x21W - 290x30x30mm	50/1	
00-841/24	3-5224	2x24W - 290x30x30mm	20/5	
00-841/28	3-5228	2x28W - 290x30x30mm	20/5	
00-841/35	3-5235	2x35W - 360x30x30mm	20/5	
00-841/54	3-5254	2x54W - 360x37x30mm	20/5	
00-841/80	3-5280	2x80W - 360x37x30mm	20/5	

**BALAST ELECTROMAGNETIC PENTRU TUBURI PL**

COD DABLEROM	COD PRODUCATOR	DENUMIRE	PAC.	PRET €
balast electromagnetic pentru tuburi PLC				
00-807/13	3-513	13W	50	
00-807/18	3-518	18W	20	
00-807/26	3-526	26W	40	



TRANSFORMATOR ELECTROMAGNETIC 230V/12V - SCHWABE

COD DABLEROM	COD PRODUCATOR	DENUMIRE	PAC.	PRET €
transformator electromagnetic tip balast 230V/12V - SCHWABE				
00-805/2	SCHWABE	50W - 230V/12V	20	
00-806/2	SCHWABE	105W - 230V/12V	20	



TRANSFORMATOR ELECTRONIC DIMABIL 230V/12VAC - SCHWABE

COD DABLEROM	COD PRODUCATOR	DENUMIRE	PAC.	PRET €
transformator electronic dimabil 230V/12V AC - SCHWABE				
00-808/2	SCHWABE	60W - 230V/12V	20	
00-812/2	SCHWABE	105W - 230V/12V	20	



BALAST ELECTROMAGNETIC PT. TUBURI T8 - SCHWABE

COD DABLEROM	COD PRODUCATOR	DENUMIRE	PAC.	PRET €
balast electromagnetic pentru tuburi fluorescente T8 - SCHWABE				
00-802/2	SCHWABE	18W T8	40	
00-803/2	SCHWABE	36W T8	40	
00-804/2	SCHWABE	58W T8	20	



BALAST ELECTRONIC PENTRU TUBURI T8 - SCHWABE

COD DABLEROM	COD PRODUCATOR	DENUMIRE	PAC.	PRET €
balast electronic pentru tuburi fluorescente T8 - 240V AC - SCHWABE				
55-845	SCHWABE	1x18W - 287x30x20mm	20/1	
55-846	SCHWABE	1x36W - 287x30x20mm	20/1	
55-847	SCHWABE	1x58W - 287x30x20mm	20/1	
55-845/2	SCHWABE	2x18W - 423x30x30mm	20/1	
55-846/2	SCHWABE	2x36W - 423x30x30mm	20/1	
55-847/2	SCHWABE	2x58W - 423x30x30mm	20/1	
55-845/4	SCHWABE	4x18W - 360x40x20mm	20/1	



BALAST ELECTRONIC PENTRU TUBURI T5 - SCHWABE

COD DABLEROM	COD PRODUCATOR	DENUMIRE	PAC.	PRET €
balast electronic pentru tuburi fluorescente T5 - 240V AC - SCHWABE				
55-841	SCHWABE	1x14W - 1x21W - 1x28W - 1x35W	20/1	
		177x22x20mm		
55-842	SCHWABE	2x14W - 2x21W - 2x28W - 2x35W	20/1	
		317x22x20mm		



BALAST MERCUR - SCHWABE

COD DABLEROM	COD PRODUCATOR	DENUMIRE	PAC.	PRET €
balast mercur - SCHWABE				
55-800	SCHWABE	80W - 112x68x36mm	6/1	
55-801	SCHWABE	125W - 112x68x36mm	6/1	
55-802	SCHWABE	250W - 145x120x75mm	6/1	
55-803	SCHWABE	400W - 180x155x110mm	6/1	
55-805	SCHWABE	1000W - 173x160x135mm	6/1	



BALAST SODIU - SCHWABE

COD DABLEROM	COD PRODUCATOR	DENUMIRE	PAC.	PRET €
balast sodiu - SCHWABE				
55-811	SCHWABE	70W - 112x86x48mm	6/1	
55-812	SCHWABE	100W - 145x120x55mm	6/1	
55-813	SCHWABE	150W - 145x120x75mm	6/1	
55-814	SCHWABE	250W - 180x155x110mm	6/1	
55-815	SCHWABE	400W - 180x155x110mm	6/1	
55-817	SCHWABE	1000W - 248x236x165mm	6/1	



CONDENSATORI PENTRU ILUMINAT - SCHWABE

COD DABLEROM	COD PRODUCATOR	DENUMIRE	PAC.	PRET €
condensatori pentru iluminat - SCHWABE				
32-206/6	SCHWABE	6 μ f - \varnothing 30:mm h:70	250/1	
32-206/7	SCHWABE	7 μ f - \varnothing 30:mm h:70	250/1	
32-206/8	SCHWABE	8 μ f - \varnothing 30:mm h:70	250/1	
32-206/9	SCHWABE	9 μ f - \varnothing 30:mm h:70	250/1	
32-206/10	SCHWABE	10 μ f - \varnothing 30:mm h:70	250/1	
32-206/12	SCHWABE	12 μ f - \varnothing 30:mm h:70	250/1	
32-206/14	SCHWABE	14 μ f - \varnothing 30:mm h:70	250/1	
32-206/16	SCHWABE	16 μ f - \varnothing 35:mm h:72	60/1	
32-206/18	SCHWABE	18 μ f - \varnothing 35:mm h:72	60/1	
32-206/20	SCHWABE	20 μ f - \varnothing 36:mm h:72	60/1	
32-206/25	SCHWABE	25 μ f - \varnothing 40:mm h:72	60/1	
32-206/30	SCHWABE	30 μ f - \varnothing 40:mm h:72	60/1	
32-206/32	SCHWABE	32 μ f - \varnothing 40:mm h:72	60/1	
32-206/40	SCHWABE	40 μ f - \varnothing 45:mm h:95	60/1	
32-206/45	SCHWABE	45 μ f - \varnothing 45:mm h:95	60/1	
32-206/50	SCHWABE	50 μ f - \varnothing 45:mm h:95	60/1	
32-206/60	SCHWABE	60 μ f - \varnothing 45:mm h:95	60/1	



TRANSFORMATOARE DE TENSIUNE MONOFAZICE

NIKOLAIDI 111
transformers

COD DABLEROM	COD PRODUCATOR	DENUMIRE	PAC.	PRET €
transformatoare monofazice IP20 la tensiuni de lucru: 110V/12V sau 110V/24V sau 110V/48V sau 110V/110V 230V/12V sau 230V/24V sau 230V/48V sau 230V/110V sau 230V/230V 400V/12V sau 400V/24V sau 400V/48V sau 400V/110V sau 400V/230V sau 400V/400V				
la comanda putem realiza si alte tensiuni in functie de necesitatile dumneavoastra				
62-...	NIKOLAIDIS	15VA - 75X68X85mm	1	
62-...	NIKOLAIDIS	20VA - 75X68X85mm	1	
62-...	NIKOLAIDIS	25VA - 75X68X85mm	1	
62-...	NIKOLAIDIS	35VA - 75X68X85mm	1	
62-...	NIKOLAIDIS	40VA - 75X73X85mm	1	
62-...	NIKOLAIDIS	50VA - 75X73X85mm	1	
62-...	NIKOLAIDIS	60VA - 84X73X85mm	1	
62-...	NIKOLAIDIS	70VA - 84X81X88mm	1	
62-...	NIKOLAIDIS	80VA - 84X86X88mm	1	
62-...	NIKOLAIDIS	100VA - 96X80X98mm	1	
62-...	NIKOLAIDIS	120VA - 96X82X98mm	1	
62-...	NIKOLAIDIS	160VA - 96X87X98mm	1	
62-...	NIKOLAIDIS	180VA - 96X92X98mm	1	
62-...	NIKOLAIDIS	200VA - 96X97X98mm	1	
62-...	NIKOLAIDIS	220VA - 96X102X98mm	1	
62-...	NIKOLAIDIS	250VA - 120X93X117mm	1	
62-...	NIKOLAIDIS	300VA - 120X98X117mm	1	
62-...	NIKOLAIDIS	350VA - 120X103X117mm	1	
62-...	NIKOLAIDIS	400VA - 120X108X117mm	1	
62-...	NIKOLAIDIS	450VA - 120X113X117mm	1	
62-...	NIKOLAIDIS	500VA - 120X118X117mm	1	
62-...	NIKOLAIDIS	600VA - 150X110X135mm	1	
62-...	NIKOLAIDIS	800VA - 150X120X135mm	1	
62-...	NIKOLAIDIS	900VA - 150X130X135mm	1	
62-...	NIKOLAIDIS	1000VA - 150X140X135mm	1	
62-...	NIKOLAIDIS	1200VA - 180X135X165mm	1	
62-...	NIKOLAIDIS	1500VA - 180X145X165mm	1	
62-...	NIKOLAIDIS	1800VA - 180X155X165mm	1	
62-...	NIKOLAIDIS	2000VA - 180X165X165mm	1	
62-...	NIKOLAIDIS	2500VA - 180X175X165mm	1	
62-...	NIKOLAIDIS	3000VA - 180X195X165mm	1	
62-...	NIKOLAIDIS	4000VA - 240X180X212mm	1	
62-...	NIKOLAIDIS	5000VA - 240X190X212mm	1	
62-...	NIKOLAIDIS	5500VA - 240X200X212mm	1	
62-...	NIKOLAIDIS	6500VA - 240X210X212mm	1	
62-...	NIKOLAIDIS	7500VA - 240X220X212mm	1	
62-...	NIKOLAIDIS	9000VA	1	
62-...	NIKOLAIDIS	10000VA	1	
62-...	NIKOLAIDIS	12000VA	1	



APARATAJ CASNIC ST "IMAGE LINE"

COD DABLEROM	COD PRODUCATOR	DENUMIRE	PAC.	PRET €
aparataj "IMAGE LINE" culoare:alb - intreruptoare la 10A 250V - prize la 16A 250V				
32-000	455.10.010	intrerupator simplu	10	
32-001	455.10.020	intrerupator simplu A/R	10	
32-002	455.10.040	intrerupator dublu	10	
32-003	455.10.050	intrerupator dublu A/R	10	
32-004	455.10.030	intrerupator intermediar A/R	10	
32-005	455.10.060	priza telefon simpla	10	
32-006	455.10.070	priza telefon dubla	10	
32-007	455.10.080	priza TV intermediara	10	
32-008	455.10.090	priza TV terminala	10	
32-009	455.10.100	priza TV+radio	10	
32-010	455.10.110	priza shouko	10	
32-011	455.10.120	priza shouko cu capac	10	
32-013	455.10.130	dimmer 600W	10	
32-014	455.10.140	buton sonerie	10	
32-015	455.10.150	buton roller dublu	10	
32-017	084.48	rama tripla	10	

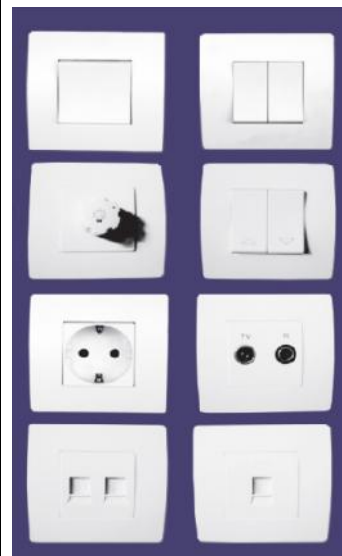
**APARATAJ CASNIC ST "SIROS 575"**

COD DABLEROM	COD PRODUCATOR	DENUMIRE	PAC.	PRET €
aparataj "SIROS 575" culoare:alb - intreruptoare la 10A 250V - prize la 16A 250V				
22-100	aliberti	intrerupator simplu	10	
22-101	aliberti	intrerupator simplu A/R	10	
22-102	aliberti	intrerupator dublu	10	
22-103	aliberti	intrerupator dublu A/R	10	
22-104	aliberti	intrerupator intermediar A/R	10	
22-105	aliberti	buton cu lumina	10	
22-106	aliberti	buton cu inscriptie si lumina	10	
22-107	aliberti	buton pentru sonerie	10	
22-108	aliberti	buton pentru usa garaj/roller	10	
22-109	aliberti	priza shouko	10	
22-110	aliberti	priza shouko cu capac	10	
22-111	aliberti	priza TV terminala	10	
22-112	aliberti	priza TV intermediara	10	
22-113	aliberti	priza telefon simpla RJ11	10	
22-114	aliberti	priza telefon dubla RJ11	10	
22-115	aliberti	priza calculator simpla RJ45	10	
22-116	aliberti	priza calculator dubla RJ45	10	
22-117	aliberti	priza radio simpla	10	
22-118	aliberti	priza radio dubla	10	
22-119	aliberti	dimmer 600W 230V	10	
22-120	aliberti	dimmer 600W 12V	10	
22-121	aliberti	dimmer 1000W 230V A/R	10	
22-122	aliberti	dimmer 1000W 12V A/R	10	

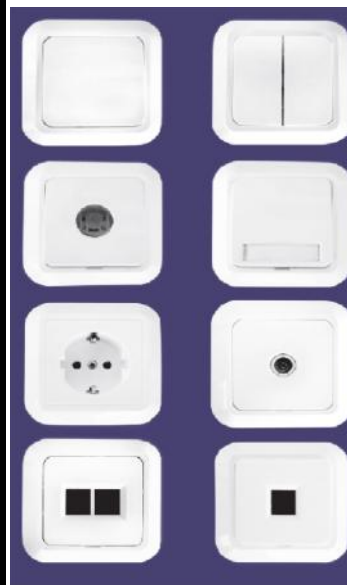
aliberti

APARATAJ PT IP44

COD DABLEROM	COD PRODUCATOR	DENUMIRE	PAC.	PRET €
aparataj PT IP44 alb - intreruptoare la 10A 250V - prize la 16A 250V				
22-600/alb	13-20501211	intrerupator simplu - alb	100/10	
22-601/alb	13-21501212	intrerupator simplu A/R - alb	100/10	
22-602/alb	13-24501221	intrerupator dublu - alb	100/10	
22-603/alb	13-23501213	intrerupator cu revenire - alb	100/10	
22-604/alb	13-25501223	priza shouko simpla cu capac - alb	100/10	
22-605/alb	13-26501223	priza dubla shouko cu capac - alb	100/10	



aparataj PT IP44 gri - intreruptoare la 10A 250V - prize la 16A 250V				
22-600/gri	13-10501211	intrerupator simplu - gri	100/10	
22-601/gri	13-11501212	intrerupator simplu A/R - gri	100/10	
22-602/gri	13-14501221	intrerupator dublu - gri	100/10	
22-603/gri	13-13501213	intrerupator cu revenire - gri	100/10	
22-604/gri	13-15501223	priza shouko simpla cu capac - gri	100/10	
22-605/gri	13-16501223	priza dubla shouko cu capac - gri	100/10	

**APARATAJ PT "SINTRA" IP65**

COD DABLEROM	COD PRODUCATOR	DENUMIRE	PAC.	PRET €
aparataj PT "SINTRA" IP65 - intreruptoare la 10A 250V - prize la 16A 250V				
11-584100	584100	intrerupator simplu	10	
11-584102	584102	intrerupator simplu A/R	10	
11-584104	584104	intrerupator intermediar A/R	10	
11-584113	584113	intrerupator dublu	10	
11-584114	584114	intrerupator dublu A/R	10	
11-584115	584115	intrerupator cu revenire	10	
11-584117	584117	intrerupator cu revenire pentru bec	10	
11-584151	584151	priza shouko cu capac	10	

**BUTON SONERIE PT CU BEC**

COD DABLEROM	CULOARE	DENUMIRE	PAC.	PRET €
buton sonerie PT cu bec				
22-040	alb	buton sonerie pe tencuiala cu bec	20/1	

**INTRERUPATOARE PE FIR/PORTATIV**

COD DABLEROM	CULOARE	DENUMIRE	PAC.	PRET €
intrerupator pe fir 2A				
31-208/alb	alb	intrerupator pe fir	50	
31-208/negru	negru	intrerupator pe fir	50	
31-208/auriu	auriu	intrerupator pe fir	50	



intrerupator portativ				
31-209	alb	intrerupator portativ	50	

MONOKROUSSOS

**PROTECTIE PENTRU PRIZE SHOUKO**

COD DABLEROM	CULOARE	DENUMIRE	PAC.	PRET €
protectia din plastic pentru prize shouko - nu necesita cheita				
31-215	alb	protectie plastic	50	

PRELUNGITOARE SIMPLE

COD DABLEROM	COD PRODUCATOR	DENUMIRE	CABLU	PAC.	PRET €
prelungitoare cu stecher bipolar si cupla bipolara & cablu 2x0.75mm²					
01-099	15-20751	cu cablu de 1.5metri	2x0.75mm ²	50	
01-100	15-20753	cu cablu de 3metri	2x0.75mm ²	50	
01-101	15-20755	cu cablu de 5metri	2x0.75mm ²	30	
01-102	15-207510	cu cablu de 10metri	2x0.75mm ²	25	



prelungitoare cu stecher shouko si cupla shouko cu protectie & cablu 3x1mm²					
01-103	15-3103	cu cablu de 3metri	3x1mm ²	50	
01-104	15-3105	cu cablu de 5metri	3x1mm ²	25	
01-105	15-3110	cu cablu de 10metri	3x1mm ²	20	



prelungitoare cu stecher shouko si cupla shouko cu protectie & cablu 3x1.5mm²					
01-106	15-31503	cu cablu de 3metri	3x1.5mm ²	50	
01-107	15-31505	cu cablu de 5metri	3x1.5mm ²	20	
01-108	15-31510	cu cablu de 10metri	3x1.5mm ²	20	
01-108/15	15-31515	cu cablu de 15metri	3x1.5mm ²	10	

**PRELUNGITOARE**

COD DABLEROM	COD PRODUCATOR	DENUMIRE	CABLU	PAC.	PRET €
prelungitoare cu prize shouko fara cablu					
31-100	15-000030	cu 3 prize shouko	fara	50	
31-101	15-000040	cu 4 prize shouko	fara	50	
31-102	15-000050	cu 5 prize shouko	fara	50	
31-103	15-000060	cu 6 prize shouko	fara	50	
31-104	15-000080	cu 8 prize (4 sh. + 4 bip.)	fara	60	



prelungitoare cu prize shouko cu cablu 1.5metri					
31-110	15-311530	cu 3 prize shouko	3x1mm ²	50	
31-111	15-311540	cu 4 prize shouko	3x1mm ²	50	
31-112	15-311550	cu 5 prize shouko	3x1mm ²	50	
31-113	15-311560	cu 6 prize shouko	3x1mm ²	50	
31-114	15-311580	cu 8 prize (4 sh. + 4 bip.)	3x1mm ²	50	



prelungitoare cu prize shouko cu cablu 1.5metri & intrerupator					
31-120	15-311531	cu 3 prize shouko	3x1mm ²	50	
31-121	15-311541	cu 4 prize shouko	3x1mm ²	50	
31-122	15-311551	cu 5 prize shouko	3x1mm ²	50	
31-123	15-311561	cu 6 prize shouko	3x1mm ²	50	
31-124	15-311581	cu 8 prize (4 sh. + 4 bip.)	3x1mm ²	50	



prelungitoare cu prize shouko cu cablu 3metri & intrerupator					
31-120/3	15-321531	cu 3 prize shouko	3x1mm ²	50	
31-121/3	15-321541	cu 4 prize shouko	3x1mm ²	50	
31-122/3	15-321551	cu 5 prize shouko	3x1mm ²	50	



PRELUNGITOARE SPECIALE

115

COD DABLEROM	COD PRODUCATOR	DENUMIRE	CABLU	PAC.	PRET €
prelungitoare cu prize shouko cu cablu 1.5metri cu intrerupator pe fiecare priza					
31-125	15-3151546	cu 4 prize shouko	3x1.5mm ²	20	
31-126	15-3151566	cu 6 prize shouko	3x1.5mm ²	20	



COD DABLEROM	COD PRODUCATOR	DENUMIRE	CABLU	PAC.	PRET €
prelungitoare cu prize shouko cu cablu 1.5metri & intrerupator cu protectie la suprasarcina & protectie la fulger					
31-150	15-3151535	cu 3 prize shouko	3x1.5mm ²	40	
31-151	15-3151545	cu 4 prize shouko	3x1.5mm ²	30	
31-152	15-3151555	cu 5 prize shouko	3x1.5mm ²	30	
31-153	15-3151565	cu 6 prize shouko	3x1.5mm ²	30	



COD DABLEROM	COD PRODUCATOR	DENUMIRE	CABLU	PAC.	PRET €
prelungitoare cu cablu 1.5metri & intrerupator cu prize shouko & TV IN-OUT & telefon IN-OUT & calculator RJ45(8P8C) IN-OUT cu protectie la suprasarcina & protectie la fulger					
31-151/2	15-31515451	cu 4 prize shouko	3x1.5mm ²	30	
31-152/2	15-31515551	cu 5 prize shouko	3x1.5mm ²	30	
31-153/2	15-31515651	cu 6 prize shouko	3x1.5mm ²	30	



COD DABLEROM	COD PRODUCATOR	DENUMIRE	CABLU	PAC.	PRET €
prelungitoare cu cablu 1.5metri 1700W cu 4 prize shouko & 4 prize bipolare optiune de MASTER-SLAVE cu reglaj la MASTER de la 10W pana la 80W cu protectie la suprasarcina & protectie la fulger					
31-155	15-311590	cu 4 shouko + 4 bipolare	3x1.5mm ²	20	



COD DABLEROM	COD PRODUCATOR	DENUMIRE	CABLU	PAC.	PRET €
prelungitoare cu cablu 1.5metri 3500W cu 4 prize shouko & 2 prize bipolare & TV IN-OUT & telefon IN-2OUT optiune de MASTER-SLAVE cu reglaj la MASTER de la 8W pana la 80W cu protectie la suprasarcina & protectie la fulger					
31-154	15-311591	cu 9 pozitii	3x1.5mm ²	20	



TAMBURI DIN PLASTIC

COD DABLEROM	COD PRODUCATOR	DENUMIRE	CABLU	PAC.	PRET €
tambur mic din plastic fara cablu Ø22cm - cu 2 prize shouko					
31-000	080/15	fara cablu - Ø22cm	fara cablu	1	

tambur mare din plastic fara cablu Ø30cm - cu 4 prize shouko					
31-001	080/01	fara cablu - Ø22cm	fara cablu	1	

COD DABLEROM	COD PRODUCATOR	DENUMIRE	CABLU	PAC.	PRET €
tambur inchis rotund din plastic cu cablu PVC 3x1.5mm² - cu 4 prize shouko					
01-109	15-315100	cu 10metri cablu PVC	3x1.5mm ²	10	

COD DABLEROM	COD PRODUCATOR	DENUMIRE	CABLU	PAC.	PRET €
tambur inchis patrat din plastic cu cablu PVC 3x1.5mm² - cu 4 prize shouko					
01-110	15-315150	cu 15metri cablu PVC	3x1.5mm ²	4	
01-111	15-315250	cu 25metri cablu PVC	3x1.5mm ²	4	

COD DABLEROM	COD PRODUCATOR	DENUMIRE	CABLU	PAC.	PRET €
tambur deschis rotund din plastic cu cablu PVC - cu 4 prize shouko					
01-112	15-315251	cu 25metri cablu PVC	3x1.5mm ²	2	
01-113	15-315501	cu 50metri cablu PVC	3x1.5mm ²	2	
01-114	15-325401	cu 40metri cablu PVC	3x2.5mm ²	1	

TAMBURI DIN METAL

COD DABLEROM	COD PRODUCATOR	DENUMIRE	CABLU	PAC.	PRET €
tambur din metal fara cablu - culoare:rosie - cu 4 prize shouko					
31-003	080/01metal	fara cablu - rosu	fara cablu	1	

COD DABLEROM	COD PRODUCATOR	DENUMIRE	CABLU	PAC.	PRET €
tambur din metal fara cablu - culoare:aluminium - cu 4 prize shouko					
31-004	15-32	fara cablu - aluminiu	fara cablu	1	

COD DABLEROM	COD PRODUCATOR	DENUMIRE	CABLU	PAC.	PRET €
tambur deschis rotund din metal cu cablu PVC - cu 4 prize shouko					
31-004/25	15-315252	cu 25metri cablu PVC	3x1.5mm ²	2	
31-004/50	15-315502	cu 50metri cablu PVC	3x1.5mm ²	2	
31-004/40	15-325402	cu 40metri cablu PVC	3x2.5mm ²	2	



STECHERE - CUPLE

COD DABLEROM	COD PRODUCATOR	DENUMIRE	PAC.	PRET €
stecher - cupla bipolară (fara CP)				
31-200	15-113	stecher bipolar (fara CP)	50	
31-201	15-114	cupla bipolară (fara CP)	25	



COD DABLEROM	COD PRODUCATOR	DENUMIRE	PAC.	PRET €
stecher - cupla shouko (cu CP)				
31-202	15-120	stecher shouko (cu CP)	50	
31-203	070/02	stecher shouko "lateral" (cu CP)	50	
31-204	15-123	cupla shouko (cu CP)	50	



COD DABLEROM	COD PRODUCATOR	DENUMIRE	PAC.	PRET €
stecher - cupla shouko (cu CP) din cauciuc				
31-222	070/03pvc	stecher shouko (cu CP) din cauciuc	50	
31-224	070/01pvc	cupla shouko (cu CP) din cauciuc	50	



COD DABLEROM	COD PRODUCATOR	DENUMIRE	PAC.	PRET €
stecher - cupla shouko (cu CP) din cauciuc - <i>freder</i>				
31-222/2	15-116	stecher shouko (cu CP) din cauciuc	25	
31-224/2	15-117	cupla shouko (cu CP) din cauciuc	25	

freder



COD DABLEROM	COD PRODUCATOR	DENUMIRE	PAC.	PRET €
triplu stecher				
31-205	070/033	triplu stecher bipolar (fara CP)	50	
31-207	15-107	triplu stecher shouko (cu CP)	20	



COD DABLEROM	COD PRODUCATOR	DENUMIRE	PAC.	PRET €
multistecher adaptor cu CP - pentru toate sisteme - 10A				
01-033	15-97	multistecher adaptor la blister	120/12	
01-033/2	15-971	multistecher adaptor	300/20	



COD DABLEROM	COD PRODUCATOR	DENUMIRE	PAC.	PRET €
priza cu CP cu programator analogic la 24ore reglabil la minim 15minute - 16A				
01-030	10-16	priza shouko cu programator analogic	48/12	



COD DABLEROM	COD PRODUCATOR	DENUMIRE	PAC.	PRET €
priza cu CP cu multimetru - masoara: Volt/Ampere/Hertz/Watt/Voltampere/Cosφ/consum				
01-0308	10-18	priza shouko cu multimetru digital	1	



SENZORI DE MISCARE

118

COD DABLEROM	COD PRODUCATOR	DENUMIRE	max.Amper	PAC.	PRET €
senzor de miscare PT - unghi detectie 180° - distanta detectie max. 12m reglaj LUX & timp(min.10sec-max.10min) - max.1200W - 230V - IP44					
00-590	10-0500	alb	6A	48/4	
00-591	10-0501	negru	6A	48/4	



COD DABLEROM	COD PRODUCATOR	DENUMIRE	max.Amper	PAC.	PRET €
senzor de miscare PT "SFERIC" - unghi detectie 180° - distanta detectie max. 12m reglaj LUX & timp(min.55sec-max.8min) - max.1200W - 230V - IP44					
00-592	10-0502	alb	6A	48/4	



COD DABLEROM	COD PRODUCATOR	DENUMIRE	max.Amper	PAC.	PRET €
senzor de miscare PT "TAVAN" - unghi detectie 360° - distanta detectie max. 10m reglaj LUX & timp(min.5sec-max.7min) & sensibilitate - max.1200W - 230V - IP20					
00-594	10-5000	alb	6A	48/4	



COD DABLEROM	COD PRODUCATOR	DENUMIRE	max.Amper	PAC.	PRET €
senzor de miscare cu dulie E27 - unghi detectie 360° - distanta detectie max. 6m reglaj LUX & timp - max.60W - 230V - IP20					
00-5662	10-502	alb - L:132mm W:56mm	1.2A	48/4	



COD DABLEROM	COD PRODUCATOR	DENUMIRE	max.Amper	PAC.	PRET €
senzor de miscare pentru corp de iluminat - unghi detectie 360° - distanta detectie max. 6m reglaj LUX & timp - max.800W - 230V - IP20					
00-5660	10-500	alb - L:56mm W:34mm	4A	100/4	



COD DABLEROM	COD PRODUCATOR	DENUMIRE	max.Amper	PAC.	PRET €
senzor de miscare ST (pentru doza de aparat) - unghi detectie 190° - distanta detectie max. 8m reglaj LUX & timp - max.1600W - 230V - IP20					
00-565	10-4700	alb	8A	40/4	



COD DABLEROM	COD PRODUCATOR	DENUMIRE	max.Amper	PAC.	PRET €
senzor de miscare ST (pentru tavan fals) - unghi detectie 360° - distanta detectie max. 6m reglaj LUX & timp - max.1200W - 230V - IP20					
00-5491	10-501	alb - D:75 h:75 Ø:63mm	6A	48/4	



COD DABLEROM	COD PRODUCATOR	DENUMIRE	max.Amper	PAC.	PRET €
senzor de miscare ST (TACTIL ON-OFF) - distanta detectie max. 5cm max.250VA - 100-240V - IP20					
00-566	10-0250	alb	250VA	100/1	



februarie 2012

SENZORI DE MISCARE SPECIALE - CU MICROUND

119

COD DABLEROM	COD PRODUCATOR	DENUMIRE	max.Amper	PAC.	PRET €
senzor de miscare PT (tavan) cu microunde - unghi detectie 360° - distanta detectie max. 8m reglaj LUX & timp & sensibilitate - max.1200W - 230V - IP20					
00-5941	10-5001	alb	6A	100/4	



COD DABLEROM	COD PRODUCATOR	DENUMIRE	max.Amper	PAC.	PRET €
plafoniera cu senzor de miscare cu microunde -unghi detectie 360°-distanta detectie max. 16m reglaj LUX & timp & sensibilitate - max.60W - 230V - IP44					
00-5942	4-360	alb cu sticla mat - Ø30cm	4A	5/1	



4-360

FOTOCELULE (SENZORI CREPUSCULARI)

COD DABLEROM	COD PRODUCATOR	DENUMIRE	max.Amper	PAC.	PRET €
fotocelula PT mini 6A max.1200W - 230V - IP44					
00-595	10-06	alb & albastru	6A	200/2	



COD DABLEROM	COD PRODUCATOR	DENUMIRE	max.Amper	PAC.	PRET €
fotocelula PT 16A max.3200W - 230V - IP54					
00-596	10-10	alb & negru	16A	100/5	



COD DABLEROM	COD PRODUCATOR	DENUMIRE	max.Amper	PAC.	PRET €
fotocelula PT (in cutie) 6A reglaj LUX & timp - max.1200W - 230V - IP54					
00-5961	10-11	alb	6A	48/4	



COD DABLEROM	COD PRODUCATOR	DENUMIRE	max.Amper	PAC.	PRET €
fotocelula (pentru corp de iluminat) 0.43A max.100W - 230V - IP20					
00-573	10-2122	alb - L:62mm D:33mm	0.43A	80/4	



COD DABLEROM	COD PRODUCATOR	DENUMIRE	max.Amper	PAC.	PRET €
fotocelula (pentru corp de iluminat) 5A max.1000W - 230V - IP20					
00-574	10-2152	alb - L:78mm D:40mm	5A	80/4	



SONERII - SIRENE

120

aliberti

COD DABLEROM	COD PRODUCATOR	DENUMIRE	PAC.	PRET €
sonerie casnica 230V				
22-020	M-350	alba - 1 melodie - cu transformator 230V	10/1	



COD DABLEROM	COD PRODUCATOR	DENUMIRE	PAC.	PRET €
sonerie casnica 12V				
22-024	M-350mini	alba - 1 melodie - 12V	10/1	



COD DABLEROM	COD PRODUCATOR	DENUMIRE	PAC.	PRET €
buzzer 6V-24V				
22-033	buzzer	alb - 6V-24V	10/1	



COD DABLEROM	COD PRODUCATOR	DENUMIRE	PAC.	PRET €
sonerie rotunda metalica - 230V sau 110V sau 48V sau 24V sau 12V - 100dB				
22-025	P200	rosie & neagra	10/1	



COD DABLEROM	COD PRODUCATOR	DENUMIRE	PAC.	PRET €
sonerie rotunda metalica pentru telefon - 230V - 100dB				
22-026	P200/T	rosie & alba - pentru telefon	10/1	



COD DABLEROM	COD PRODUCATOR	DENUMIRE	PAC.	PRET €
sonerie din plastic fara fir - baterii 2x1.5V - 1 melodie - raza de acoperire 80metri				
01-011	15-803	alba	10/1	



COD DABLEROM	COD PRODUCATOR	DENUMIRE	PAC.	PRET €
sonerie pe sina electronica 230V				
02-345	20-3001	alba - electronica - 1 modul	240/12	



COD DABLEROM	COD PRODUCATOR	DENUMIRE	PAC.	PRET €
sirene - 105dB (cu reglaj)				
30-BS540	BS-540	alba & bej - 12V-24V	10/1	
30-BS545	BS-545	alba & bej - 230V	10/1	

olympia electronics



TERMOSTAT CAMERA				
COD DABLEROM	COD PRODUCATOR	DENUMIRE	PAC.	PRET €
temostat pentru camera - cu 4 contacte - reglaj 5-35°C				
01-007	10-200	alb & gri - 5-35°C	96/1	



februarie 2012

ACCESORII TELEFON

121

COD DABLEROM	COD PRODUCATOR	DENUMIRE	PAC.	PRET €
mufe tata (clips) pentru telefon/calculator				
01-223	17-001	receptor - 4P 4C	100	
01-224/4	17-002	telefon - 6P 4C	100	
01-224/6	17-004	telefon - 6P 6C	100	
01-225	17-003	calculator - 8P 8C	100	



COD DABLEROM	COD PRODUCATOR	DENUMIRE	PAC.	PRET €
cablu spiral cu mufe 4P 4C pentru receptor				
01-200	17-0220	alb - 2 metri	200/50	
01-201	17-02200	bej - 2 metri	200/50	
01-202	17-0221	negru - 2 metri	200/50	
01-203	17-0226	gri - 2 metri	200/50	
01-204	17-0240	alb - 4 metri	200/50	
01-206	17-0241	negru - 4 metri	200/50	



COD DABLEROM	COD PRODUCATOR	DENUMIRE	PAC.	PRET €
conector prelungire 6P 4C				
01-226	17-008	mufe 6P 4C : 1 mama + 1 mama	50	
01-227	17-009	mufe 6P 4C : 1 mama + 2 mama	50	



COD DABLEROM	COD PRODUCATOR	DENUMIRE	PAC.	PRET €
conector ramificatie 6P 4C				
01-229	17-0010	mufa 6P 4C : 1 tata + 2 mama	50	
01-230	17-0011	mufa 6P 4C : 1 tata + 3 mama	50	
01-231	17-0012	mufa 6P 4C : 1 tata + 5 mama	50	



COD DABLEROM	COD PRODUCATOR	DENUMIRE	PAC.	PRET €
conector rotativ				
01-232	17-006	conector rotativ cu mufe: tata + mama	10	



COD DABLEROM	COD PRODUCATOR	DENUMIRE	PAC.	PRET €
prize telefon PT cu autocolant				
01-234	17-011	alba - simpla 6P 4C	50	
01-235	17-012	alba - dubla 6P 4C	50	



ACCESORII TV

COD DABLEROM	COD PRODUCATOR	DENUMIRE	PAC.	PRET €
mufe TV				
31-210	420.30.020	mufa TV mama	100	
31-211	420.30.010	mufa TV tata	100	
31-212	420.30.070	mufa TV splitter (1 tata + 2 mama)	100	



SIGURANTE AUTOMATE

COD DABLEROM	COD PRODUCATOR	DENUMIRE	PAC.	PRET €
sigurante automate monopolare - 1modul				
02-350	20-0102	2A	120/12	
02-351	20-0104	4A	120/12	
02-352	20-0106	6A	120/12	
02-353	20-0110	10A	120/12	
02-354	20-0116	16A	120/12	
02-355	20-0120	20A	120/12	
02-356	20-0125	25A	120/12	
02-357	20-0132	32A	120/12	
02-358	20-0140	40A	120/12	
02-359	02-0150	50A	120/12	
02-360	20-0163	63A	120/12	

freder®

COD DABLEROM	COD PRODUCATOR	DENUMIRE	PAC.	PRET €
sigurante automate faza+nul - 1modul				
02-361	20-2210	10A	120/12	
02-362	20-2216	16A	120/12	
02-363	20-2220	20A	120/12	
02-364	20-2225	25A	120/12	
02-365	20-2232	32A	120/12	

COD DABLEROM	COD PRODUCATOR	DENUMIRE	PAC.	PRET €
sigurante automate tripolare - 3modul				
02-366	20-0306	6A	40/4	
02-367	20-0310	10A	40/4	
02-368	20-0316	16A	40/4	
02-369	20-0320	20A	40/4	
02-370	20-0325	25A	40/4	
02-371	20-0332	32A	40/4	
02-372	20-0340	40A	40/4	
02-373	20-0350	50A	40/4	
02-374	20-0363	63A	40/4	



COD DABLEROM	COD PRODUCATOR	DENUMIRE	PAC.	PRET €
sigurante automate E27				
02-346	20-21100	10A - E27	200/10	
02-347	20-21160	16A - E27	200/10	
02-348	20-21200	20A - E27	200/10	
02-349	20-21250	25A - E27	200/10	

**INTRERUPATOARE PE SINA**

COD DABLEROM	COD PRODUCATOR	DENUMIRE	PAC.	PRET €
intrerupatoare pe sina				
02-339	20-3401	1p. x 63A	240/12	
02-340	20-3402	2p. x 63A	120/6	
02-341	20-3633	3p. x 63A	80/4	
02-342	20-31003	3p. x 100A	80/4	



PROTECTIE DIFERENTIALA

COD DABLEROM	COD PRODUCATOR	DENUMIRE	PAC.	PRET €
protectia diferentiala monofazica - 2 modul - 30mA				
02-335/10	20-5110	2poli x 10A - 30mA	4/1	
02-335/20	20-5120	2poli x 20A - 30mA	4/1	
02-335/25	20-5125	2poli x 25A - 30mA	4/1	
02-335/40	20-5140	2poli x 40A - 30mA	4/1	
02-335/63	20-5160	2poli x 63A - 30mA	4/1	

protectia diferentiala trifazica - 4 modul - 30mA				
02-336/32	20-5332	4poli x 32A - 30mA	4/1	
02-336/40	20-5340	4poli x 40A - 30mA	4/1	
02-336/63	20-5363	4poli x 63A - 30mA	4/1	

CONTOARE PE SINA

COD DABLEROM	COD PRODUCATOR	DENUMIRE	PAC.	PRET €
contor pe sina				
02-553/an	26-1301	monofazic - 1 modul 45A - analogic	10/1	
02-553/dig	26-13010	monofazic - 1 modul 45A - digital	10/1	
02-554/an	26-1302	monofazic - 4 modul 100A - analogic	36/1	
02-554/dig	26-13020	monofazic - 4 modul 100A - digital	60/1	
02-552/an	26-3301	trifazic - 6 modul 100A - analogic	24/1	
02-552/dig	26-33010	trifazic - 6 modul 100A - digital	30/1	

SONERII PE SINA

COD DABLEROM	COD PRODUCATOR	DENUMIRE	PAC.	PRET €
sonerie pe sina electronica 230V				
02-345	20-3001	alba - electronica - 1 modul	240/12	

LAMPA INDICATOARE PE SINA

COD DABLEROM	COD PRODUCATOR	DENUMIRE	PAC.	PRET €
lampa indicatoare pe sina - lumina:rosie				
02-344	20-3000	1 modul - lumina:rosie	120/12	

AUTOMAT DE SCARA

COD DABLEROM	COD PRODUCATOR	DENUMIRE	PAC.	PRET €
automat de scara - electronic - 16A				
32-019	280.16.010	reglaj:1-7min. - 16A	10/1	

PROTECTIE ANTIFULGER PE SINA & ACCESORII

COD DABLEROM	COD PRODUCATOR	DENUMIRE	PAC.	PRET €
protectia antifulger - max.(In):40KA				
32-031	265.10.010	1pole - 230V/320V - cu soclu pe sina	2/1	
32-032	265.10.020	2poli - 230V/320V - cu soclu pe sina	2/1	
32-034	265.10.030	4poli - 400V/420V - cu soclu pe sina	2/1	
32-038	265.10.040	element de inlocuire pentru 1pol/2poli	2/1	
32-039	265.10.050	element de inlocuire pentru 4poli	2/1	



PROGRAMATOARE

COD DABLEROM	COD PRODUCATOR	DENUMIRE	PAC.	PRET €
programatoare pe sina				
02-375/1	10-2416	analogic - 24h - 16A - autonomie 150h	200/12	
02-375/3	10-2417	analogic - 24h - 16A - autonomie 150h	100/5	
02-376	10-2418	digital - 160h - 16A - autonomie 150h	100/1	
programatoare PT cu carcasa metalica				
01-032	10-2414	analogic - 24h - 20A - autonomie 150h	20/1	

**CONTOR DE TIMP**

COD DABLEROM	COD PRODUCATOR	DENUMIRE	PAC.	PRET €
contor de timp pentru usa tablou				
02-556	10-2412	pentru usa tablou - 230V AC	100/1	
02-557	10-24121	rama pentru 02-556	2/1	

**RELEE DE TIMP & SOCLU**

COD DABLEROM	COD PRODUCATOR	DENUMIRE	PAC.	PRET €
releu de timp - 8 picioare - 2 contacte(1+1)				
02-524	11-08220	230V AC - 3A - reglaj: 1 sec. - 80 min.	120/10	
02-525	11-08222	24-240V AC/DC - 5A - reglaj:1sec.-100h.	100/1	
02-582	11-80	soclu pe sina pentru relee cu 8 picioare	600/20	

**RELEE AUXILIARE & SOCLURI**

COD DABLEROM	COD PRODUCATOR	DENUMIRE	PAC.	PRET €
releu auxiliar cu LED & test buton - 8 picioare - 2 contacte				
02-560	11-2061	6V AC	300/20	
02-561	11-2060	6V DC	300/20	
02-562	11-2121	12V AC	300/20	
02-563	11-2120	12V DC	300/20	
02-564	11-2241	24V AC	300/20	
02-565	11-2240	24V DC	300/20	
02-566	11-2481	48V AC	300/20	
02-567	11-2480	48V DC	300/20	
02-568	11-21101	110V AC	300/20	
02-569	11-21100	110V DC	300/20	
02-570	11-22301	230V AC	300/20	
02-582	11-80	soclu pe sina pentru relee cu 8 picioare	600/20	

**releu auxiliar cu LED & test buton - 11 picioare - 3 contacte**

02-571	11-3061	6V AC	300/20	
02-572	11-3060	6V DC	300/20	
02-573	11-3121	12V AC	300/20	
02-574	11-3120	12V DC	300/20	
02-575	11-3241	24V AC	300/20	
02-576	11-3240	24V DC	300/20	
02-577	11-3481	48V AC	300/20	
02-578	11-3480	48V DC	300/20	
02-579	11-31101	110V AC	300/20	
02-580	11-31100	110V DC	300/20	
02-581	11-32301	230V AC	300/20	
02-583	11-110	soclu pe sina pentru relee cu 11picioare	400/20	



PRIZE SHOUKO PENTRU TABLOU

125

COD DABLEROM	COD PRODUCATOR	DENUMIRE	PAC.	PRET €
priza shouko pentru tablou				
32-020	26-000	priza shouko pentru sina	10/1	
32-021	423.10.020	priza shouko cu capac pentru usa	10/1	



BARE DE NUL

COD DABLEROM	COD PRODUCATOR	DENUMIRE	PAC.	PRET €
bara de nul				
02-426	12-4	cu 4 suruburi - L:4cm - 7x9mm	200/50	
02-427	12-7	cu 8 suruburi - L:7cm - 7x9mm	100/25	
02-428	12-50	cu 65 suruburi - L:50cm - 7x9mm	100/10	
02-429	215.11.010	suport din plastic pentru bare de nul	100/50	



bare de nul la cutie - 500V

32-590	212.10.010	2bare x 7poli - 100A - dim:5x9.4x4.6cm	2/1	
32-591	212.10.020	4bare x 7poli - 100A - dim:5x10.3x8.5cm	2/1	
32-592	212.10.030	4bare x 11poli - 125A - dim:5x15x8.5cm	2/1	
32-593	212.10.040	4bare x 15poli - 125A - dim:5x18x8.5cm	2/1	



PRESETUPE IP68

COD DABLEROM	COD PRODUCATOR	DENUMIRE	PAC.	PRET €
presetupe cu inel - IP68				
02-831	1-60110	∅:11mm	100	
02-832	1-60135	∅:13.5mm	100	
02-833	1-6016	∅:16mm	100	
02-834	1-6021	∅:21mm	100	
02-835	1-6029	∅:29mm	50	
02-836	1-6036	∅:36mm	20	



BARA IZOLATA 1m

COD DABLEROM	COD PRODUCATOR	DENUMIRE	PAC.	PRET €
bara izolata 1m				
02-377	20-411	monofazica - 1m	100/20	
02-378	20-413	trifazica - 1m	50/10	
02-379	20-414	faza+nul - 1m	50/10	



SINA DIN 1m

COD DABLEROM	COD PRODUCATOR	DENUMIRE	PAC.	PRET €
sina "Ω" - 1m				
02-435	1-2	galvanizata - 1m	100/20	
02-436	1-1	aluminiu - 1m	100/20	



TILE PENTRU TABLOU

COD DABLEROM	COD PRODUCATOR	DENUMIRE	PAC.	PRET €
tile pentru tablou - 16.5cm (pentru 8 module)				
39-036	030/04	alb - pentru 8 module	100/50	



februarie 2012

CONTACTOARE

freder®

126

COD DABLEROM	COD PRODUCATOR	PUTERE LA 380V	CONTACTE	PAC.	PRET €
contactoare "freder" cu bobina la 230V					
02-440	26-0400	4KW - 9A mini	1 ND	100	
02-441/0	26-040	4KW - 9A	1 ND	50/1	
02-441/1	26-041	4KW - 9A	1 NI	50/1	
02-442/0	26-055	5.5KW - 12A	1 ND	50/1	
02-442/1	26-0551	5.5KW - 12A	1 NI	50/1	
02-443/0	26-075	7.5KW - 18A	1 ND	50/1	
02-443/1	26-0751	7.5KW - 18A	1 NI	50/1	
02-444/0	26-110	11KW - 25A	1 ND	50/1	
02-444/1	26-1101	11KW - 25A	1 NI	50/1	
02-445/0	26-150	15KW - 32A	1 ND	50/1	
02445/1	26-1501	15KW - 32A	1 NI	50/1	
02-446	26-180	18.5KW - 40A	1 ND + 1 NI	20/1	
02-447	26-220	22KW - 50A	1 ND + 1 NI	20/1	
02-448	26-300	30KW - 63A	1 ND + 1 NI	20/1	
02-449	26-370	37KW - 80A	1 ND + 1 NI	15/1	
02-450	26-450	45KW - 95A	1 ND + 1 NI	15/1	
02-451	26-550	55KW - 115A	1 ND + 1 NI	4/1	
02-452	26-750	75KW - 150A	1 ND + 1 NI	4/1	
02-453/185	26-900	90KW - 185A	1 ND + 1 NI	4/1	
02-453/225	26-1100	110KW - 225A	2 ND + 2 NI	1	
02-453/265	26-1132	132KW - 265A	2 ND + 2 NI	1	
02-453/300	044.10.170	160KW - 300A	2 ND + 2 NI	1	
02-453/400	044.10.180	220KW - 400A	2 ND + 2 NI	1	
02-453/500	044.10.190	250KW - 500A	2 ND + 2 NI	1	
02-453/630	044.10.200	330KW - 630A	2 ND + 2 NI	1	
02-453/800	044.10.210	440KW - 800A	2 ND + 2 NI	1	



CONTACTE AUXILIARE

COD DABLEROM	COD PRODUCATOR	CONTACTE	PAC.	PRET €
contacte auxiliare pentru contactoare				
02-454	26-41	1 ND + 1 NI	2/1	
02-455	26-42	2 ND	2/1	
02-456	26-43	2 NI	2/1	
02-457	26-44	2 ND + 2 NI	2/1	



RELEE TERMICE

freder®

127

COD DABLEROM	COD PRODUCATOR	REGLAJ	PT. CONTACTOR	PAC.	PRET €
relee termice pentru contactoare					
02-473	26-130631	0.63A pana la 1A	4KW - 7.5KW	100/1	
02-474	26-131160	1.1A pana la 1.6A	4KW - 7.5KW	100/1	
02-476	26-131625	1.6A pana la 2.5A	4KW - 7.5KW	100/1	
02-476A	26-132231	2.2A pana la 3.1A	4KW - 7.5KW	100/1	
02-477	26-132540	2.5A pana la 4A	4KW - 7.5KW	100/1	
02-478	26-134060	4A pana la 6A	4KW - 7.5KW	100/1	
02-479	26-135580	5.5A pana la 8A	4KW - 7.5KW	100/1	
02-480	26-137010	7A pana la 10A	4KW - 7.5KW	100/1	
02-481	26-139013	9A pana la 13A	4KW - 7.5KW	100/1	
02-482	26-131218	12A pana la 18A	4KW - 7.5KW	100/1	
02-483	26-131725	17A pana la 25A	4KW - 7.5KW	100/1	
02-484	26-132332	23A pana la 32A	4KW - 7.5KW	100/1	
02-485	26-232332	23A pana la 32A	11KW - 15KW	60/1	
02-486	26-232836	28A pana la 36A	11KW - 15KW	60/1	
02-486/2	26-233040	30A pana la 40A	11KW - 15KW	60/1	
02-487	26-332332	23A pana la 32A	18.5KW - 45KW	50/1	
02-488	26-333040	30A pana la 40A	18.5KW - 45KW	50/1	
02-489	26-333750	37A pana la 50A	18.5KW - 45KW	50/1	
02-490	26-334865	48A pana la 65A	18.5KW - 45KW	50/1	
02-491	26-335570	55A pana la 70A	18.5KW - 45KW	50/1	
02-492	26-336380	63A pana la 70A	18.5KW - 45KW	50/1	
02-493	26-338093	80A pana la 93A	18.5KW - 45KW	50/1	
02-494	26-534880	48A pana la 80A	55KW - 132KW	1	
02-495	26-5360100	60A pana la 100A	55KW - 132KW	1	
02-496	26-5390150	90A pana la 150A	55KW - 132KW	1	



BOBINE PENTRU CONTACTOARE

COD DABLEROM	COD PRODUCATOR	TENSIUNE	PT. CONTACTOR	PAC.	PRET €
bobine pentru contactoare					
02-458	26-7524	24V	4KW - 7.5KW	10/1	
02-459	26-7548	48V	4KW - 7.5KW	10/1	
02-460	26-75110	110V	4KW - 7.5KW	10/1	
02-461	26-75230	230V	4KW - 7.5KW	10/1	
02-462	26-75380	380V	4KW - 7.5KW	10/1	
02-463	26-1524	24V	11KW - 15KW	10/1	
02-464	26-1548	48V	11KW - 15KW	10/1	
02-465	26-15110	110V	11KW - 15KW	10/1	
02-466	26-15230	230V	11KW - 15KW	10/1	
02-467	26-15380	380V	11KW - 15KW	10/1	
02-468	26-4524	24V	18.5KW - 45KW	10/1	
02-469	26-4548	48V	18.5KW - 45KW	10/1	
02-470	26-45110	110V	18.5KW - 45KW	10/1	
02-471	26-45230	230V	18.5KW - 45KW	10/1	
02-472	26-45380	380V	18.5KW - 45KW	10/1	
02-472/2	26-55230	230V	55KW - 75KW	10/1	
02-472/3	26-55380	380V	55KW - 75KW	10/1	
02-472/4	26-90230	230V	90KW	10/1	



MOTORSTARTER IN CUTIE IP55

freder[®]

128

COD DABLEROM	COD PRODUCATOR	REGLAJ	CONTACTOR	PAC.	PRET €
motorstarter cu contactor si rele termice in cutie - IP55 - 380V					
02-400	23-1016	1A pana la 1.6A	7.5KW	16/1	
02-401	23-1625	1.6A pana la 2.5A	7.5KW	16/1	
02-402	23-2540	2.5A pana la 4A	7.5KW	16/1	
02-403	23-4060	4A pana la 6A	7.5KW	16/1	
02-404	23-5580	5.5A pana la 8A	7.5KW	16/1	
02-405	23-7010	7A pana la 10A	7.5KW	16/1	
02-406	23-9013	9A pana la 13A	7.5KW	16/1	
02-407	23-1218	12A pana la 18A	7.5KW	16/1	
02-408	23-1725	17A pana la 25A	11KW	16/1	
02-409	23-2332	23A pana la 32A	15KW	16/1	



MOTORSTARTER CU FIXARE PE SINA - FREDER

freder[®]

COD DABLEROM	COD PRODUCATOR	DENUMIRE	PAC.	PRET €
motorstarter cu fixare pe sina tip "freder"				
32-972/fr	25-1016	reglaj de la 1A pana la 1.6A	50/1	
32-973/fr	25-1624	reglaj de la 1.6A pana la 2.5A	50/1	
32-975/fr	25-2440	reglaj de la 2.5A pana la 4A	50/1	
32-977/fr	25-4060	reglaj de la 4A pana la 6.3A	50/1	
32-979/fr	25-60100	reglaj de la 6.3A pana la 10A	50/1	
32-982/fr	25-100160	reglaj de la 10A pana la 16A	50/1	
32-984/fr	25-140200	reglaj de la 14A pana la 20A	50/1	
32-985/fr	25-180250	reglaj de la 18A pana la 25A	50/1	



MOTORSTARTER CU FIXARE PE SINA - NORA

COD DABLEROM	COD PRODUCATOR	DENUMIRE	PAC.	PRET €
motorstarter cu fixare pe sina tip "nora"				
32-970	240.10.010	reglaj de la 0.4A pana la 0.63A	50/1	
32-971	240.10.020	reglaj de la 0.63A pana la 1A	50/1	
32-972	240.10.030	reglaj de la 1A pana la 1.6A	50/1	
32-973	240.10.040	reglaj de la 1.6A pana la 2.5A	50/1	
32-974	240.10.050	reglaj de la 2A pana la 3.2A	50/1	
32-975	240.10.060	reglaj de la 2.5A pana la 4A	50/1	
32-976	240.10.070	reglaj de la 3.2A pana la 5A	50/1	
32-977	240.10.080	reglaj de la 4A pana la 6.3A	50/1	
32-978	240.10.090	reglaj de la 5A pana la 8A	50/1	
32-979	240.10.100	reglaj de la 6A pana la 10A	50/1	
32-980	240.10.110	reglaj de la 8A pana la 12A	50/1	
32-981	240.10.120	reglaj de la 9A pana la 14A	50/1	
32-982	240.10.130	reglaj de la 10A pana la 16A	50/1	
32-983	240.10.140	reglaj de la 13A pana la 18A	50/1	
32-984	240.10.150	reglaj de la 16A pana la 20A	50/1	
32-985	240.10.160	reglaj de la 17A pana la 23A	50/1	
32-986	240.10.170	reglaj de la 20A pana la 26A	50/1	
32-987	240.10.180	reglaj de la 24A pana la 32A	50/1	
32-989	240.15.010	cutie plastic gal - 15x8.5x9.5cm	50/1	

400/415V
50/60HZ



februarie 2012

INTRERUPATOARE CIRCULARE CU CAME & ACCESORII

COD DABLEROM	COD PRODUCATOR	DENUMIRE	PAC.	PRET €
intrerupatoare circulare cu came 0-1 - 1 pol				
63-000	MT15-10	1x10A - 0-1	10/1	
63-001	MT15-16	1x16A - 0-1	10/1	
63-002	MT15-25	1x25A - 0-1	10/1	



intrerupatoare circulare cu came 0-1 - 3 pol				
63-004	MT19-10	1x10A - 0-1	10/1	
63-005	MT19-16	1x16A - 0-1	10/1	
63-006	MT19-25	1x25A - 0-1	10/1	
63-007	MT19-40	1x40A - 0-1	5/1	
63-008	MT19-63	1x63A - 0-1	5/1	
63-009	MT19-100	1x100A - 0-1	5/1	
63-010	MT19-125	1x125A - 0-1	5/1	
63-011	MT19-160	1x160A - 0-1	5/1	
63-012	MT19-200	1x200A - 0-1	5/1	



intrerupatoare circulare cu came 1-0-2 - 1 pol				
63-013	MT27-10	1x10A - 1-0-2	10/1	
63-014	MT27-16	1x16A - 1-0-2	10/1	
63-015	MT27-25	1x25A - 1-0-2	10/1	

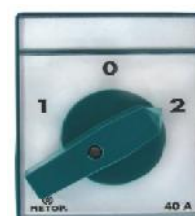

intrerupatoare circulare cu came 1-0-2 - 3 pol				
63-016	MT29-10	1x10A - 1-0-2	10/1	
63-017	MT29-16	1x16A - 1-0-2	10/1	
63-018	MT29-25	1x25A - 1-0-2	10/1	
63-019	MT29-40	1x40A - 1-0-2	5/1	
63-020	MT29-63	1x63A - 1-0-2	5/1	
63-021	MT29-100	1x100A - 1-0-2	5/1	
63-022	MT29-125	1x125A - 1-0-2	5/1	
63-023	MT29-160	1x160A - 1-0-2	5/1	
63-024	MT29-200	1x200A - 1-0-2	5/1	



intrerupatoare circulare cu came - stea triunghi "0-Y-Δ"				
63-031	MT31-16	16A - 0-Y-Δ	10/1	
63-032	MT31-25	25A - 0-Y-Δ	10/1	
63-033	MT31-40	40A - 0-Y-Δ	5/1	
63-034	MT31-63	63A - 0-Y-Δ	5/1	
63-035	MT31-100	100A - 0-Y-Δ	5/1	
63-036	MT31-160	160A - 0-Y-Δ	5/1	



cutie pentru intrerupatoare cu came				
63-900	MT-059	cutie pentru 1x10A	10/1	
63-905	MT-055	cutie pentru 1x16A/3x16A/1x25A/3x25A	5/1	
63-910	MT-058	cutie pentru 1x40A/3x40A/1x63A/3x63A	5/1	



intrerupator voltmetric / ampermetric				
63-090	11-600	intrerupator voltmetric 7 pozitii	10/1	
63-091	11-601	intrerupator ampermetric 3 pozitii	10/1	



SIGURANTE MPR (NH TIP gG) - WEBER



COD DABLEROM	COD PRODUCATOR	DENUMIRE	PAC.	PRET €
sigurante MPR - No 00 - gG				
02-202	86-00069	No 000 - 6A	120/3	
02-203	86-00109	No 000 - 10A	120/3	
02-204	86-00169	No 000 - 16A	120/3	
02-205	86-00209	No 000 - 20A	120/3	
02-206	86-00259	No 000 - 25A	120/3	
02-207	86-00329	No 000 - 32A	120/3	
02-208	86-00359	No 000 - 35A	120/3	
02-209	86-00409	No 000 - 40A	120/3	
02-210	86-00509	No 000 - 50A	120/3	
02-211	86-00639	No 000 - 63A	120/3	
02-212	86-00809	No 000 - 80A	120/3	
02-213	86-001009	No 000 - 100A	120/3	
02-214	86-001259	No 00 - 125A	60/3	
02-215	86-001609	No 00 - 160A	60/3	

sigurante MPR - No 0 - gG				
02-216	86-0259	No 0 - 25A	36/3	
02-217	86-0359	No 0 - 35A	36/3	
02-218	86-0509	No 0 - 50A	36/3	
02-219	86-0639	No 0 - 63A	36/3	
02-220	86-0809	No 0 - 80A	36/3	
02-221	86-01009	No 0 - 100A	36/3	
02-222	86-01259	No 0 - 125A	36/3	
02-223	86-01609	No 0 - 160A	36/3	

sigurante MPR - No 1 - gG				
02-224	86-10259	No 1c - 25A	36/3	
02-225	86-10359	No 1c - 35A	36/3	
02-226	86-10509	No 1c - 50A	36/3	
02-227	86-10639	No 1c - 63A	36/3	
02-228	86-10809	No 1c - 80A	36/3	
02-229	86-11009	No 1c - 100A	36/3	
02-230	86-11259	No 1c - 125A	36/3	
02-231	86-11609	No 1c - 160A	36/3	
02-232	86-12009	No 1 - 200A	36/3	
02-233	86-12509	No 1 - 250A	36/3	

sigurante MPR - No 2 - gG				
02-234	86-20359	No 2c - 35A	30/3	
02-235	86-20509	No 2c - 50A	30/3	
02-236	86-20639	No 2c - 63A	30/3	
02-237	86-20809	No 2c - 80A	30/3	
02-238	86-21009	No 2c - 100A	30/3	
02-239	86-21259	No 2c - 125A	30/3	
02-240	86-21609	No 2c - 160A	30/3	
02-241	86-22009	No 2c - 200A	30/3	
02-242	86-22509	No 2c - 250A	30/3	
02-243	86-23159	No 2 - 315A	30/3	
02-244	86-23559	No 2 - 355A	30/3	
02-245	86-24009	No 2 - 400A	30/3	



SIGURANTE MPR (NH TIP gG) - WEBER



131

COD DABLEROM	COD PRODUCATOR	DENUMIRE	PAC.	PRET €
sigurante MPR - No 3 - gG				
02-246	86-33159	No 3c - 315A	24/3	
02-247	86-33559	No 3c - 355A	24/3	
02-248	86-34009	No 3c - 400A	24/3	
02-249	86-35009	No 3 - 500A	24/3	
02-250	86-36309	No 3 - 630A	24/3	



sigurante MPR - No 4 - gG				
02-251	86-4630	No 4 - 630A	3/1	
02-252	86-4800	No 4 - 800A	3/1	
02-253	86-41000	No 4 - 1000A	3/1	
02-254	86-41250	No 4 - 1250A	3/1	

SOCLURI MONOPOLARE PENTRU SIGURANTE MPR - DF

COD DABLEROM	COD PRODUCATOR	DENUMIRE	PAC.	PRET €
socluri monopolare pentru sigurante MPR - material:duroplast				
02-255	86-10031	No 00 - max.160A - (1+1 surub)	54/3	
02-256	86-1004	No 00 - max.160A - (2+2 surub)	54/3	
02-257	86-101	No 0 - max.160A	3/1	
02-258	86-1110	No 1 - max.250A	3/1	
02-259	86-121	No 2 - max.400A	3/1	
02-260	86-131	No 3 - max.630A	3/1	



SOCLURI TRIPOLARE PENTRU SIGURANTE MPR - WEBER

COD DABLEROM	COD PRODUCATOR	DENUMIRE	PAC.	PRET €
socluri tripolare pentru sigurante MPR - material:duroplast				
02-270	86-300	No 00 - max.160A - (1+1 surub)	36/1	
02-271	86-302	No 00 - max.160A - (2+2 surub)	36/1	



SOCLURI TRIPOLARE INCHISE PENTRU SIGURANTE MPR - WEBER

COD DABLEROM	COD PRODUCATOR	DENUMIRE	PAC.	PRET €
socluri tripolare inchise pentru sigurante MPR				
02-284	86-500	No 00 - max.160A - (1+1 surub)	2/1	
02-285	86-501	No 1 - max.250A	2/1	
02-286	86-502	No 2 - max.400A	2/1	



MANER PENTRU SIGURANTE MPR - WEBER

COD DABLEROM	COD PRODUCATOR	DENUMIRE	PAC.	PRET €
maner pentru sigurante MPR grupa 00/0/1/2/3				
02-283	86-003	maner pentru MPR grupa 00/1/2/3	5/1	



SIGURANTE CILINDRICE (TIP gG) - WEBER



132

COD DABLEROM	COD PRODUCATOR	DENUMIRE	PAC.	PRET €
sigurante cilindrice tip gG - 10x38mm - weber				
02-106	88-001	10x38mm - 1A	50/10	
02-107	88-002	10x38mm - 2A	50/10	
02-108	88-004	10x38mm - 4A	50/10	
02-109	88-006	10x38mm - 6A	50/10	
02-110	88-010	10x38mm - 10A	50/10	
02-111	88-016	10x38mm - 16A	50/10	
02-112	88-020	10x38mm - 20A	50/10	
02-113	88-025	10x38mm - 25A	50/10	
02-114	88-032	10x38mm - 32A	50/10	
sigurante cilindrice tip gG - 14x51mm - weber				
02-115	88-102	14x51mm - 2A	50/10	
02-116	88-104	14x51mm - 4A	50/10	
02-117	88-106	14x51mm - 6A	50/10	
02-118	88-110	14x51mm - 10A	50/10	
02-119	88-116	14x51mm - 16A	50/10	
02-120	88-120	14x51mm - 20A	50/10	
02-121	88-125	14x51mm - 25A	50/10	
02-122	88-132	14x51mm - 32A	50/10	
02-123	88-140	14x51mm - 40A	50/10	
02-124	88-150	14x51mm - 50A	50/10	
sigurante cilindrice tip gG - 22x58mm - weber				
02-125	88-2006	22x58mm - 6A	50/10	
02-126	88-2010	22x58mm - 10A	50/10	
02-127	88-2016	22x58mm - 16A	50/10	
02-128	88-2020	22x58mm - 20A	50/10	
02-129	88-2025	22x58mm - 25A	50/10	
02-130	88-2032	22x58mm - 32A	50/10	
02-131	88-2040	22x58mm - 40A	50/10	
02-132	88-2050	22x58mm - 50A	50/10	
02-133	88-2063	22x58mm - 63A	50/10	
02-134	88-2080	22x58mm - 80A	50/10	
02-135	88-2100	22x58mm - 100A	50/10	
02-136	88-2125	22x58mm - 125A	50/10	



SOCLURI PENTRU SIGURANTE CILINDRICE

COD DABLEROM	COD PRODUCATOR	DENUMIRE	PAC.	PRET €
socluri monopolare cu fixare pe sina pentru sigurante cilindrice - DF				
02-147	88-9132	10x38mm - max.1x32A	192/12	
02-148	88-9163	14x51mm - max.1x50A	90/6	
02-149	88-91125	22x58mm - max.1x125A	36/6	
socluri tripolare cu fixare pe sina pentru sigurante cilindrice - DF				
02-150	88-9332	10x38mm - max.3x32A	64/4	
02-151	88-9363	14x51mm - max.3x50A	30/2	
02-152	88-93125	22x58mm - max.3x125A	12/2	
socluri cu fixare pe sina pentru sigurante cilindrice - "ADELEQ"				
02-158	88-91320	10x38mm - max.1x32A - MONOPOLARA	240/12	
02-159	88-93320	10X38mm - max.3x32A - TRIPOLARA	120/4	



februarie 2012

CONDENSATORI PENTRU MOTOARE 450V - LIFASA

COD DABLEROM	COD PRODUCATOR	DENUMIRE	PAC.	PRET €
condensatori pentru motoare 450V				
32-100	082.10.010	2mF - h:56.6mm D:25mm	10/1	
32-101	082.10.020	3mF - h:60mm D:30mm	10/1	
32-102	082.10.030	4mF - h:72mm D:30mm	10/1	
32-103	082.10.040	5mF - h:69.5mm D:30mm	10/1	
32-104	082.10.050	6mF - h:69.5mm D:30mm	10/1	
32-105	082.10.060	8mF - h:69.5mm D:30mm	10/1	
32-106	082.10.070	10mF - h:69.5mm D:30mm	10/1	
32-107	082.10.080	12mF - h:69.5mm D:35mm	10/1	
32-108	082.10.090	14mF - h:69.5mm D:35mm	10/1	
32-109	082.10.100	15mF - h:69.5mm D:35mm	10/1	
32-110	082.10.110	16mF - h:69.5mm D:40mm	10/1	
32-111	082.10.120	18mF - h:93.5mm D:35mm	10/1	
32-112	082.10.130	20mF - h:93.5mm D:35mm	10/1	
32-113	082.10.140	25mF - h:93.5mm D:40mm	10/1	
32-114	082.10.150	30mF - h:93.5mm D:40mm	10/1	
32-115	082.10.160	35mF - h:118.5mm D:45mm	10/1	
32-116	082.10.170	40mF - h:118.5mm D:45mm	10/1	
32-117	082.10.180	45mF - h:118.5mm D:45mm	10/1	
32-118	082.10.190	50mF - h:118.5mm D:50mm	10/1	
32-119	082.10.200	55mF - h:121mm D:50mm	10/1	
32-120	082.10.210	60mF - h:118.5mm D:55mm	10/1	
32-121	082.10.220	70mF - h:118.5mm D:55mm	10/1	
32-122	082.10.230	80mF - h:121.5mm D:60mm	10/1	

**INTRERUPATOARE**

COD DABLEROM	COD PRODUCATOR	DENUMIRE	PAC.	PRET €
intrerupatoare ST - ON-OFF				
02-545	11-05	cu bec - simplu - 3 contacte - 15A	40	
02-546	11-06	cu bec - dublu - 6 contacte - 16A	20	
02-547	11-07	cu bec -simplu lat - 4 contacte - 16A	20	



intrerupatoare pentru usa				
02-548	11-15	ON-OFF - 4 contacte - 15A	10	
02-549	11-16	ON-OFF-ON - 6 contacte - 15A	10	
02-550	11-17	ON-OFF-ON cu revenire- 6 contacte- 15A	10	

**INTRERUPATOARE DE PICIOR**

COD DABLEROM	COD PRODUCATOR	DENUMIRE	PAC.	PRET €
intrerupatoare de picior - metalice - tip greu - 250V 10A				
32-720	365.12.010	1 ND - 1 NI	2/1	
32-721	365.12.020	2 ND - 2 NI	2/1	
32-722	365.12.030	1 ND - 1 NI cu protectie	2/1	
32-723	365.12.040	2 ND - 2 NI cu protectie	2/1	



intrerupatoare de picior - mini - 250V 10A				
32-724	365.10.010	1 ND - 1 NI plastic	2/1	
32-725	365.10.020	1 ND - 1 NI metalic	2/1	



BUTOANE - Ø22mm

freder®

134

COD DABLEROM	COD PRODUCATOR	DENUMIRE	PAC.	PREȚ €
buton simplu				
02-540	11-01	simplu verde (start)	500/10	
02-541	11-02	simplu rosu (stop)	500/10	



buton simplu cu contact				
32-750	156.10.010	simplu rosu cu 1 contact inchis (NI)	50/10	
32-751	156.10.020	simplu verde cu 1 contact deschis (ND)	50/10	



buton cu lumina si contact				
32-755	156.10.030	lumina verde cu 1 contact deschis (ND)	50/10	
32-756	156.10.040	lumina rosie cu 1 contact inchis (NI)	50/10	
32-757	156-10.050	lumina galbena cu 1 contact deschis (ND)	50/10	



buton dublu cu contact				
32-760	156.10.130	verde - rosu (start-stop) cu contacte 1 deschis (ND) + 1 inchis (NI)	50/10	



buton "ciuperca" cu contact				
32-765	156.10.120	rosu - buton: Ø40mm - cu retinere cu 1 contacte inchis (NI)	50/10	
32-766	156.10.110	rosu - buton: Ø60mm - cu revenire cu 1 contacte inchis (NI)	50/10	

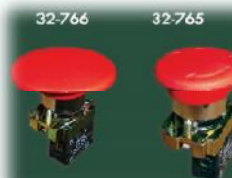

INTRERUPATOARE ROTATIVE - Ø22mm

COD DABLEROM	COD PRODUCATOR	DENUMIRE	PAC.	PREȚ €
intrerupator rotativ - cu maner scurt				
32-770	156.10.080	0-1 cu retinere - 1 contact deschis (ND)	50/10	
32-771	156.10.090	1-0-2 cu retinere- 2contacte deschis (ND)	50/10	



intrerupator rotativ - cu maner lung				
32-777	156.10.100	1-0-1 cu revenire- 2contacte deschis (ND)	50/10	



intrerupator rotativ - cu cheie				
32-780	156.10.140	0-1 cu retinere- 1 contact deschis (ND)	50/10	

CONTACTE AUXILIARE

COD DABLEROM	COD PRODUCATOR	DENUMIRE	PAC.	PREȚ €
contacte auxiliare				
32-790	156.12.010	contact auxiliar normal deschis (ND)	50/10	
32-791	156.12.020	contact auxiliar normal inchis (NI)	50/10	



CAPAC SILICONIC - Ø22mm

COD DABLEROM	COD PRODUCATOR	DENUMIRE	PAC.	PREȚ €
capac siliconic alb pentru a transforma butonul Ø22mm in IP65				
32-795	159.14.010	capac siliconic alb	50/10	



LAMPI DE SEMNALIZARE - Ø22mm

COD DABLEROM	COD PRODUCATOR	DENUMIRE	PAC.	PRET €
lampa de semnalizare - Ø22mm				
32-740/12	162.10.230	12V AC/DC - rosu - cu led	50/10	
32-741/12	162.10.240	12V AC/DC - verde - cu led	50/10	
32-742/12	162.10.250	12V AC/DC - galben - cu led	50/10	
32-740/24	162.10.190	24V AC/DC - rosu - cu led	50/10	
32-741/24	162.10.200	24V AC/DC - verde - cu led	50/10	
32-742/24	162.10.210	24V AC/DC - galben - cu led	50/10	
32-743/24	162.10.220	24V AC/DC - alb - cu led	50/10	
32-740/48	162.10.160	48V AC/DC - rosu - cu led	50/10	
32-741/48	162.10.170	48V AC/DC - verde - cu led	50/10	
32-742/48	162.10.180	48V AC/DC - galben - cu led	50/10	
32-740/110	162.10.130	110V AC/DC - rosu - cu led	50/10	
32-741/110	162.10.140	110V AC/DC - verde - cu led	50/10	
32-742/110	162.10.150	110V AC/DC - galben - cu led	50/10	
02-534	11-012	230V AC - rosu - cu led	500/10	
02-533	11-011	230V AC - verde - cu led	500/10	
02-535	11-013	230V AC - galben - cu led	500/10	
32-743/230	162.10.040	230V AC - alb - cu led	50/10	
32-744/230	162.10.050	230V AC - albastru - cu led	50/10	
32-730	156.10.170	230V AC - rosu - cu bec B9aS	50/10	
32-731	156.10.160	230V AC - verde - cu bec B9aS	50/10	
32-732	156.10.180	230V AC - galben - cu bec B9aS	50/10	



CUTII PENTRU BUTOANE Ø22mm

COD DABLEROM	COD PRODUCATOR	DENUMIRE	PAC.	PRET €
cutie din plastic pentru butoane Ø22mm				
32-701	360.18.010	pentru 1 buton	10/1	
32-702	360.18.020	pentru 2 butoane	10/1	
32-703	360.18.030	pentru 3 butoane	10/1	
32-704	360.18.040	pentru 4 butoane	10/1	
32-705	360.18.050	pentru 5 butoane	10/1	
32-706	360.18.060	pentru 6 butoane	10/1	



CUTIE METALICA CU BUTOANE

COD DABLEROM	COD PRODUCATOR	DENUMIRE	PAC.	PRET €
cutie metalica cu 2 butoane ON-OFF				
02-421	26-0330	trifazic 3x30A	100/1	



CUTII DE COMANDA CU BUTOANE - 5A - IP65

COD DABLEROM	COD PRODUCATOR	DENUMIRE	PAC.	PRET €
cutie de comanda complet echipata - 5A - IP65				
32-726	360.26.010	cu 2 butoane	2/1	
32-727	360.26.020	cu 4 butoane	2/1	
32-728	360.26.030	cu 6 butoane	2/1	



VOLTMETRE TABLOU - DIRECTE AC

136

COD DABLEROM	COD PRODUCATOR	DENUMIRE	PAC.	PRET €
voltmetru AC direct pentru tablou				
02-652	11-380500	80x80mm - 0-500V	100/1	
02-653	11-5723007	72x72mm - 0-300V	100/1	
02-654	11-5725007	72x72mm - 0-500V	100/1	
02-655	11-5963007	96x96mm - 0-300V	100/1	
02-656	11-5965007	96x96mm - 0-500V	100/1	



AMPERMETRU TABLOU - INDIRECT AC - 72x72mm

COD DABLEROM	COD PRODUCATOR	DENUMIRE	PAC.	PRET €
ampermetru gol indirect AC (prin transformator de curent) pentru tablou & placi				
02-673	11-472057	ampermetru gol 72x72mm - ... / 5A	100/1	
02-674	11-400607	placa (pentru 02-673) - 60A	100/1	
02-675	11-401007	placa (pentru 02-673) - 100A	100/1	
02-676	11-401507	placa (pentru 02-673) - 150A	100/1	
02-677	11-402007	placa (pentru 02-673) - 200A	100/1	
02-678	11-402507	placa (pentru 02-673) - 250A	100/1	
02-679	11-403007	placa (pentru 02-673) - 300A	100/1	
02-680	11-404007	placa (pentru 02-673) - 400A	100/1	
02-681	11-406007	placa (pentru 02-673) - 600A	100/1	
02-682	11-408007	placa (pentru 02-673) - 800A	100/1	
02-683	11-4010007	placa (pentru 02-673) - 1000A	100/1	
02-684	11-4012007	placa (pentru 02-673) - 1200A	100/1	

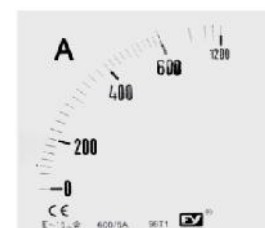

AMPERMETRU TABLOU INDIRECT AC - 96x96mm

COD DABLEROM	COD PRODUCATOR	DENUMIRE	PAC.	PRET €
ampermetru gol indirect AC (prin transformator de curent) pentru tablou & placi				
02-685	11-496057	ampermetru gol 96x96mm - ... / 5A	100/1	
02-686	11-4607	placa (pentru 02-685) - 60A	100/1	
02-687	11-41007	placa (pentru 02-685) - 100A	100/1	
02-688	11-41507	placa (pentru 02-685) - 150A	100/1	
02-689	11-42007	placa (pentru 02-685) - 200A	100/1	
02-690	11-42507	placa (pentru 02-685) - 250A	100/1	
02-691	11-43007	placa (pentru 02-685) - 300A	100/1	
02-692	11-44007	placa (pentru 02-685) - 400A	100/1	
02-693	11-45007	placa (pentru 02-685) - 500A	100/1	
02-694	11-46007	placa (pentru 02-685) - 600A	100/1	
02-695	11-48007	placa (pentru 02-685) - 800A	100/1	
02-696	11-410007	placa (pentru 02-685) - 1000A	100/1	
02-697	11-412007	placa (pentru 02-685) - 1200A	100/1	
02-698	11-41500	placa (pentru 02-685) - 1500A	100/1	
02-699	11-416007	placa (pentru 02-685) - 1600A	100/1	
02-700	11-420007	placa (pentru 02-685) - 2000A	100/1	
02-701	11-425007	placa (pentru 02-685) - 2500A	100/1	
02-702	11-430007	placa (pentru 02-685) - 3000A	100/1	
02-703	11-440007	placa (pentru 02-685) - 4000A	100/1	



AMPERMETRE TABLOU - INDIRECTE AC - 80x80mm

COD DABLEROM	COD PRODUCATOR	DENUMIRE	PAC.	PRET €
ampermetru indirect AC (prin transformator de curent) pentru tablou				
02-665	11-480405	80x80mm - 40A / 5A	100/1	
02-666	11-480605	80x80mm - 60A / 5A	100/1	
02-667	11-481005	80x80mm - 100A / 5A	100/1	
02-668	11-481505	80x80mm - 150A / 5A	100/1	
02-669	11-482005	80x80mm - 200A / 5A	100/1	
02-670	11-483005	80x80mm - 250A / 5A	100/1	
02-671	11-484005	80x80mm - 300A / 5A	100/1	
02-672	11-486005	80x80mm - 400A / 5A	100/1	



TRANSMATTOARE CURENT 220V .../5A

COD DABLEROM	COD PRODUCATOR	DENUMIRE	PAC.	PRET €
transformator curent Ø30mm 220V .../5A				
02-704	11-930040	transformator Ø30mm - 40A/5A	40/1	
02-705	11-930060	transformator Ø30mm - 60A/5A	40/1	
02-706	11-930100	transformator Ø30mm - 100A/5A	40/1	
02-707	11-930150	transformator Ø30mm - 150A/5A	40/1	
02-708	11-930200	transformator Ø30mm - 200A/5A	40/1	
02-709	11-930250	transformator Ø30mm - 250A/5A	40/1	
02-710	11-930300	transformator Ø30mm - 300A/5A	40/1	
02-711	11-930400	transformator Ø30mm - 400A/5A	40/1	



transformator curent Ø40mm 220V .../5A				
02-712	11-940100	transformator Ø40mm - 100A/5A	40/1	
02-713	11-940150	transformator Ø40mm - 150A/5A	40/1	
02-714	11-940200	transformator Ø40mm - 200A/5A	40/1	
02-715	11-940250	transformator Ø40mm - 250A/5A	40/1	
02-716	11-940300	transformator Ø40mm - 300A/5A	40/1	
02-717	11-940400	transformator Ø40mm - 400A/5A	40/1	
02-718	11-940500	transformator Ø40mm - 500A/5A	40/1	
02-719	11-940600	transformator Ø40mm - 600A/5A	40/1	



transformator curent Ø60mm 220V .../5A				
02-720	11-960100	transformator Ø60mm - 600A/5A	30/1	
02-721	11-960800	transformator Ø60mm - 800A/5A	30/1	
02-722	11-960100	transformator Ø60mm - 1000A/5A	30/1	



transformator curent Ø100mm 220V .../5A				
02-723	11-910010	transformator Ø100mm - 1000A/5A	20/1	
02-724	11-910012	transformator Ø100mm - 1200A/5A	20/1	
02-725	11-910016	transformator Ø100mm - 1600A/5A	20/1	
02-726	11-910020	transformator Ø100mm - 2000A/5A	20/1	
02-727	11-910025	transformator Ø100mm - 2500A/5A	20/1	
02-728	11-910030	transformator Ø100mm - 3000A/5A	20/1	
02-729	11-910040	transformator Ø100mm - 4000A/5A	20/1	

VENTILATOARE SIMPLE PENTRU TABLOU & ACCESORII

COD DABLEROM	COD PRODUCATOR	DENUMIRE	PAC.	PRET €
ventilator pentru tablou - 230V AC				
02-430	11-09225	92x92x25mm 230V	50/1	
02-431	11-012025	120x120x25mm 230V	40/1	
02-432	11-012038	120x120x38mm 230V	40/1	



grilaj pentru ventilator				
02-433	11-092251	grilaj pentru ventilator 92x92xmm	50/1	
02-434	11-0120251	grilaj pentru ventilator 120x120xmm	40/1	

**VENTILATOARE CU FILTRU PENTRU TABLOU & ACCESORII**

COD DABLEROM	COD PRODUCATOR	DENUMIRE	PAC.	PRET €
ventilator cu grilaj si filtru pentru tablou - 230V AC - IP54				
32-950	312.10.010	92x92mm - 20m ³ /h - 16W	2/1	
32-951	312.10.030	124x124mm - 55m ³ /h - 19W	2/1	
32-952	312.10.050	177x177mm - 105m ³ /h - 19W	2/1	
32-953	312.10.070	224x224mm - 230m ³ /h - 41W	2/1	



grilaj cu filtru pentru ventilator				
32-960	312.10.020	116.5X116.5mm pentru 32-950	2/1	
32-961	312.10.040	148.5x148.5mm pentru 32-951	2/1	
32-962	312.10.060	204x204mm pentru 32-952	2/1	
32-963	312.10.080	250x250mm pentru 32-953	2/1	

**TERMOSTATE PE SINA - IP20**

COD DABLEROM	COD PRODUCATOR	DENUMIRE	PAC.	PRET €
termostat pentru pornirea ventilatoarelor/dispozitivelor optice/dispozitivelor acustice				
32-933	354.10.010	250VAC 10A 120VDC 15A	2/1	



termostat pentru pornirea dispozitivelor de incalzire				
32-934	354.10.020	250VAC 10A 120VDC 15A	2/1	

termostat cu 2 functii (de la 32-933 & de la 32-934)				
32-935	354.10.030	250VAC 10A 120VDC 15A	2/1	

**DIMMERE PROFESIONALE**

COD DABLEROM	COD PRODUCATOR	DENUMIRE	PAC.	PRET €
dimmer pe sina pentru becuri/motoare monofazice				
32-940	280.18.010	1000W 180V-230V AC	2/1	



dimmer pe perete pentru becuri/motoare monofazice				
32-941	280.18.020	2500W 180V-230V AC	2/1	



LAMPI AVARIE - IP55

COD DABLEROM	COD PRODUCATOR	DENUMIRE	PAC.	PRET €
lampa avarie(girofar) cu bec B14 - 150x100mm - 200rotatie/minut - IP55				
33-900/12	375.10.010	rosie - 10W - 12V DC	2/1	
33-900/24	375.10.050	rosie - 8W - 24V DC	2/1	
33-900/110	375.10.090	rosie - 8W - 110V AC	2/1	
33-900/230	375.10.130	rosie - 8W - 230V AC	2/1	
33-901/12	375.10.020	galbena - 10W - 12V DC	2/1	
33-901/24	375.10.060	galbena - 8W - 24V DC	2/1	
33-901/110	375.10.100	galbena - 8W - 110V AC	2/1	
33-901/230	375.10.140	galbena - 8W - 230V AC	2/1	
33-902/12	375.10.030	albastra - 10W - 12V DC	2/1	
33-902/24	375.10.070	albastra - 8W - 24V DC	2/1	
33-902/110	375.10.110	albastra - 8W - 110V AC	2/1	
33-902/230	375.10.150	albastra - 8W - 230V AC	2/1	
33-903/12	375.10.040	verde - 10W - 12V DC	2/1	
33-903/24	375.10.080	verde - 8W - 24V DC	2/1	
33-903/110	375.10.120	verde - 8W - 110V AC	2/1	
33-903/230	375.10.160	verde - 8W - 230V AC	2/1	

**LAMPI AVARIE CU SIRENA - IP55**

COD DABLEROM	COD PRODUCATOR	DENUMIRE	PAC.	PRET €
lampl avarie(girofar) cu sirena cu bec B14 - 177x122mm - 200rotatie/minut - 70db la 1m - IP55				
33-910/12	375.24.010	rosie - 10W - 12V DC	2/1	
33-910/24	375.24.050	rosie - 10W - 24V DC	2/1	
33-910/110	375.24.090	rosie - 10W - 110V AC	2/1	
33-910/230	375.24.130	rosie - 10W - 230V AC	2/1	
33-911/12	375.24.020	galbena - 10W - 12V DC	2/1	
33-911/24	375.24.060	galbena - 10W - 24V DC	2/1	
33-911/110	375.24.100	galbena - 10W - 110V AC	2/1	
33-911/230	375.24.140	galbena - 10W - 230V AC	2/1	
33-912/12	375.24.030	albastra - 10W - 12V DC	2/1	
33-912/24	375.24.070	albastra - 10W - 24V DC	2/1	
33-912/110	375.24.110	albastra - 10W - 110V AC	2/1	
33-912/230	375.24.150	albastra - 10W - 230V AC	2/1	
33-913/12	375.24.040	verde - 10W - 12V DC	2/1	
33-913/24	375.24.080	verde - 10W - 24V DC	2/1	
33-913/110	375.24.120	verde - 10W - 110V AC	2/1	
33-913/230	375.24.160	verde - 10W - 230V AC	2/1	



LIMITATORI - 10A

COD DABLEROM	COD PRODUCATOR	DENUMIRE	PAC.	PRET €
limitatori gama LXX - 40x94.1x41.5mm - contacte:1ND/1NI - 10A				
33-000	370.10.010	LXX3 20 S/B - 1ND+1NI - 10A	2/1	
33-001	370.10.020	LXX3 20 S/T - 1ND+1NI - 10A	2/1	
33-002	370.10.060	LXX3 20 S/J - 1ND+1NI - 10A	2/1	
33-004	370.10.030	LXX3 20 S/Z - 1ND+1NI - 10A	2/1	
33-005	370.10.040	LXX3 20 S/L - 1ND+1NI - 10A	2/1	
33-006	370.10.050	LXX3 20 S/W - 1ND+1NI - 10A	2/1	

LXX3 20 S/B
CA2 (135.52)LXX3 20 S/J (Αξονάκι) (135.56)
LXX3 20 S/D (Ελατήριο) (135.57)
Cl & Cl FLXX3 20S S/Z
D (135.58)LXX3 20S S/L
D2 (135.60)LXX3 20S S/W
NJ (135.62)LXX3 20S S/T
CA 1 - 2 (135.54)**LIMITATORI - 5A**

COD DABLEROM	COD PRODUCATOR	DENUMIRE	PAC.	PRET €
limitatori gama AZ - 28x86.5x25mm - contacte:1ND/1NI - 5A				
33-010	370.15.010	AZ 8104 - 1ND+1NI - 5A	10/1	
33-011	370.15.020	AZ 8108 - 1ND+1NI - 5A	10/1	
33-012	370.15.030	AZ 8111 - 1ND+1NI - 5A	10/1	
33-013	370.15.040	AZ 8122 - 1ND+1NI - 5A	10/1	
33-014	370.15.050	AZ 8166 - 1ND+1NI - 5A	10/1	
33-015	370.15.060	AZ 8107 - 1ND+1NI - 5A	10/1	



AZ 8104 (135.71)



AZ 8108 (135.73)



AZ 8111 (135.75)



AZ 8122 (135.77)



AZ 8166 (135.79)



AZ 8107 (135.81)

LIMITATORI - 10A

COD DABLEROM	COD PRODUCATOR	DENUMIRE	PAC.	PRET €
limitatori gama V - 27.8x16.9x10.3mm - contacte:1ND/1NI - 10A - 250VAC				
33-020	370.20.010	V10-C2 - 1ND+1NI - 10A	100/10	
33-021	370.20.020	V10-FL2-C2 - 1ND+1NI - 10A	100/10	
33-022	370.20.030	V10-FL111-C2 - 1ND+1NI - 10A	100/10	
33-023	370.20.040	V10-FL22B - 1ND+1NI - 10A	100/10	
33-024	370.20.050	V10-FL13-C2 - 1ND+1NI - 10A	100/10	



V10 - C2 (135.02)



V10 - FL2 - C2 (135.04)



V10 - FL111 - C2 (135.06)



V10 - FL22B (135.05)



V10 - FL13 - C2 (135.08)

LIMITATORI - 10A

COD DABLEROM	COD PRODUCATOR	DENUMIRE	PAC.	PRET €
limitatori gama Z - 49.2x23.8x17.4mm - contacte:1ND/1NI - 10A - 250VAC				
33-030	370.25.010	Z15 GD - 1ND+1NI - 10A	100/20	
33-031	370.25.020	Z15 GW - 1ND+1NI - 10A	100/20	
33-032	370.25.030	Z15 GW2 - 1ND+1NI - 10A	100/20	
33-033	370.25.040	Z15 GW 2277 - 1ND+1NI - 10A	100/20	
33-034	370.25.050	Z15 GQ 22 - 1ND+1NI - 10A	100/20	



Z - 15 GD (135.20)



Z - 15 GW (135.22)



Z - 15 GW 2 (135.28)



Z - 15 GW 2277 (135.24)



Z - 15 GQ 22 (135.26)

PRIZE INDUSTRIALE - GEYER

142

GEYER

COD DABLEROM	COD PRODUCATOR	DENUMIRE	PAC.	PRET €
priza industrială pe cablu - GEYER				
34-300	31001	3x16A - 230V - IP44	10	
34-301	31005	4x16A - 400V - IP44	10	
34-302	303	5x16A - 400V - IP44	10	
34-303	31013	3x32A - 230V - IP44	10	
34-304	31017	4x32A - 400V - IP44	10	
34-305	304	5x32A - 400V - IP44	10	
34-306	3104	3x63A - 230V - IP44	5	
34-307	3151	4x63A - 400V - IP44	5	
34-308	3112	5x63A - 400V - IP44	5	
34-309	3191	3x125A - 230V - IP67	5	
34-310	3195	4x125A - 400V - IP67	5	
34-311	3199	5x125A - 400V - IP67	5	



priza industrială pe tencuială - GEYER				
34-312	11765	3x16A - 230V - IP44	10	
34-313	11645	4x16A - 400V - IP44	10	
34-314	100	5x16A - 400V - IP44	10	
34-315	11651	3x32A - 230V - IP44	10	
34-316	11646	4x32A - 400V - IP44	10	
34-317	101	5x32A - 400V - IP44	10	
34-318	1104	3x63A - 230V - IP44	10	
34-319	1127	4x63A - 400V - IP44	10	
34-320	1124	5x63A - 400V - IP44	10	
34-321	11437	3x125A - 230V - IP67	10	
34-322	11441	4x125A - 400V - IP67	10	
34-323	11447	5x125A - 400V - IP67	10	



priza industrială sub tencuială - GEYER				
34-324	1217	3x16A - 230V - IP44	10	
34-325	1221	4x16A - 400V - IP44	10	
34-326	1227	5x16A - 400V - IP44	10	
34-327	1229	3x32A - 230V - IP44	10	
34-328	1233	4x32A - 400V - IP44	10	
34-329	1239	5x32A - 400V - IP44	10	
34-330	1307	3x63A - 230V - IP44	5	
34-331	134	4x63A - 400V - IP44	5	
34-332	136	5x63A - 400V - IP44	5	
34-333	13452	3x125A - 230V - IP67	5	
34-334	13447	4x125A - 400V - IP67	5	
34-335	13451	5x125A - 400V - IP67	5	



priza industrială specială - GEYER				
32-370	710	sub tencuila shouko - IP44	20	
32-371	7130	sub tencuila shouko din poliamida-IP44	20	
32-372	724	pe tencuila shouko - IP44	20	
32-373	7409	pe cablu shouko - IP54	20	
32-379	107	pe tencuila shouko + 5x16A - IP44	10	
32-380	108	pe tencuila shouko + 5x32A - IP44	10	

COD DABLEROM	COD PRODUCATOR	DENUMIRE	PAC.	PRET €
stecher industrial pe cablu - GEYER				
34-336	21001	3x16A - 230V - IP44	10	
34-337	21005	4x16A - 400V - IP44	10	
34-338	203	5x16A - 400V - IP44	10	
34-339	21013	3x32A - 230V - IP44	10	
34-340	21017	4x32A - 400V - IP44	10	
34-341	204	5x32A - 400V - IP44	10	
34-342	2104	3x63A - 230V - IP44	5	
34-343	2151	4x63A - 400V - IP44	5	
34-344	2155	5x63A - 400V - IP44	5	
34-345	2191	3x125A - 230V - IP67	5	
34-346	2195	4x125A - 400V - IP67	5	
34-347	2199	5x125A - 400V - IP67	5	



stecher industrial pe tencuiala - GEYER				
34-348	240	3x16A - 230V - IP44	10	
34-349	24329	4x16A - 400V - IP44	10	
34-350	24142	5x16A - 400V - IP44	10	
34-351	24331	3x32A - 230V - IP44	10	
34-352	24330	4x32A - 400V - IP44	10	
34-353	24143	5x32A - 400V - IP44	10	
34-354	24336	3x63A - 230V - IP44	5	
34-355	24338	4x63A - 400V - IP44	5	
34-356	24134	5x63A - 400V - IP44	5	
34-357	24198	3x125A - 230V - IP67	1	
34-358	24200	4x125A - 400V - IP67	1	
34-359	24202	5x125A - 400V - IP67	1	



stecher industrial sub tencuiala - GEYER				
34-360	28111	3x16A - 230V - IP44	10	
34-361	28112	4x16A - 400V - IP44	10	
34-362	282001	5x16A - 400V - IP44	10	
34-363	28010	3x32A - 230V - IP44	10	
34-364	28012	4x32A - 400V - IP44	10	
34-365	282002	5x32A - 400V - IP44	10	



stecher industrial cu CP pe cablu - GEYER				
32-374	7302	stecher cu CP pe cablu - IP44	20	



CLEME

144

COD DABLEROM	COD PRODUCATOR	DENUMIRE	PAC.	PRET €
cleme 12poli				
01-560	8-004	4mm ² - 12poli-din polietilena(PE) 80°C	300/50	
01-561	8-006	6mm ² - 12poli-din polietilena(PE) 80°C	300/50	
01-562	8-010	10mm ² - 12poli-din polietilena(PE) 80°C	300/50	
01-563	8-016	16mm ² - 12poli-din polietilena(PE) 80°C	200/10	
01-564	8-025	25mm ² - 12poli-din polietilena(PE) 80°C	100/10	



01-565	8-104	4mm ² - 12poli-din poliamida(PA) 150°C	300/50	
01-566	8-106	6mm ² - 12poli-din poliamida(PA) 150°C	300/50	
01-567	8-110	10mm ² - 12poli-din poliamida(PA) 150°C	300/50	
01-568	8-116	16mm ² - 12poli-din poliamida(PA) 150°C	200/10	
01-569	8-125	25mm ² - 12poli-din poliamida(PA) 150°C	100/10	

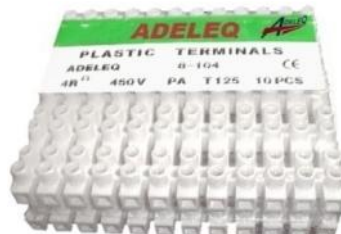

COD DABLEROM	COD PRODUCATOR	DENUMIRE	PAC.	PRET €
cleme terminale				
01-570	8-316	16mm ² - 8poli	200/10	
01-571	8-325	25mm ² - 8poli	200/10	
01-572	8-335	35mm ² - 8poli	80/10	
01-573/50	8-350	50mm ² - 8poli	60/10	
01-573/70	8-370	70mm ² - 8poli	40/10	



COD DABLEROM	COD PRODUCATOR	DENUMIRE	PAC.	PRET €
conectori terminali - ITALIA				
31-320	31320	1.5mm ² - 10poli	100/50	
31-321	31321	2.5mm ² - 10poli	100/50	
31-322	31322	4mm ² - 10poli	100/50	
31-323	31323	6mm ² - 10poli	100/50	
31-324	31324	10mm ² - 10poli	100/50	
31-325	31325	16mm ² - 5poli	100/50	



conectori terminali - FREDER				
31-321/fr	31321fr	2.5mm ² - 5poli	100/50	
31-322/fr	31322fr	4mm ² - 5poli	100/50	
31-323/fr	31323fr	6mm ² - 5poli	100/50	
31-324/fr	31324fr	10mm ² - 5poli	100/50	
31-325/fr	31325fr	16mm ² - 5poli	100/50	

freder[®]



COD DABLEROM	COD PRODUCATOR	DENUMIRE	PAC.	PRET €
cleme portelan				
01-577	8-2061	6mm ² - 1pol	100	
01-578	8-2062	6mm ² - 2poli	50	
01-579	8-2063	6mm ² - 3poli	50	
01-583	8-2161	10mm ² - 1pol	50	
01-584	8-2162	10mm ² - 2poli	20	
01-585	8-2163	10mm ² - 3poli	20	



CLEME PE SINA & ACCESORII

COD DABLEROM	COD PRODUCATOR	DENUMIRE	PAC.	PRET €
clema euro pe sina - gri				
32-500	198.15.010	gri - 0.2 - 2.5mm ²	100/50	
32-501	198.15.020	gri - 2.5 - 4mm ²	100/50	
32-502	198.15.030	gri - 4 - 6mm ²	100/50	
32-503	198.15.040	gri - 6 - 10mm ²	100/50	
32-504	198.15.050	gri - 10 - 16mm ²	100/50	
32-505	198.15.060	gri - 16 - 35mm ²	100/50	



clema euro pe sina - albastra				
32-512	198.25.010	albastra - 0.2 - 2.5mm ²	100/50	
32-513	198.25.020	albastra - 2.5 - 4mm ²	100/50	
32-514	198.25.030	albastra - 4 - 6mm ²	100/50	
32-515	198.25.040	albastra - 6 - 10mm ²	100/50	
32-516	198.25.050	albastra - 10 - 16mm ²	100/50	
32-517	198.25.060	albastra - 16 - 35mm ²	100/50	

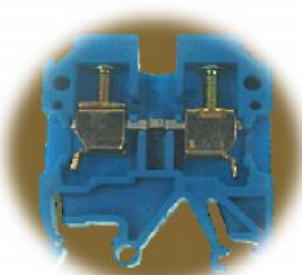

clema euro pe sina - galben-verde				
32-506	198.20.010	galben-verde - 0.2 - 2.5mm ²	100/50	
32-507	198.20.020	galben-verde - 0.2 - 4mm ²	100/50	
32-508	198.20.030	galben-verde - 0.2 - 6mm ²	100/50	
32-509	198.20.040	galben-verde - 0.5 - 10mm ²	100/50	
32-510	198.20.050	galben-verde - 0.5 - 16mm ²	100/50	
32-511	198.20.060	galben-verde - 10 - 35mm ²	100/50	



placute terminale pentru cleme euro pe sina				
32-520	199.18.010	pentru clema euro de 2.5mm ²	100/50	
32-521	199.18.020	pentru clema euro de 4mm ²	100/50	
32-522	199.18.030	pentru clema euro de 6mm ²	100/50	
32-523	199.18.040	pentru clema euro de 10mm ²	100/50	
32-524	199.18.050	pentru clema euro de 16mm ²	100/50	
32-525	199.18.060	pentru clema euro de 35mm ²	100/50	



numere pentru cleme euro				
32-550	199.19	set 10 numere 1..10 pentru cleme euro	100	



suport pe sina "denumire"				
32-540	199.18.070	suport pe sina "denumire"	100	



opritor pe sina pentru cleme euro				
32-530	196.10.060	opritor din plastic	50/10	
32-531	196.10.050	opritor din metal	50/10	



CLEME PE SINA

COD DABLEROM	COD PRODUCATOR	DENUMIRE	PAC.	PRET €
cleme pe sina inscriptionabile - 600V				
32-560	209.15.010	1x60A - 14mm ²	10	
32-561	209.15.020	1x90A - 22mm ²	5	
32-562	209.15.030	1x130A - 38mm ²	5	
32-563	209.15.040	1x240A - 100mm ²	2	
32-565	209.15.050	3x20A - 2mm ²	10	
32-566	209.15.060	3x30A - 3.5mm ²	10	
32-567	209.15.070	3x50A - 8mm ²	10	

**IZOLATORI**

COD DABLEROM	COD PRODUCATOR	DENUMIRE	PAC.	PRET €
izolatori octogonali - 500V				
32-570	100.10.080	M5 - h:20mm D:Ø15mm	120/12	
32-571	100.10.070	M6 - h:30mm D:Ø30mm	120/12	
02-422	12-006	M6 - h:35mm D:Ø31mm	500/10	
32-572	100.10.060	M6 - h:40mm D:Ø30mm	120/12	
02-423	12-008	M8 - h:35mm D:Ø31mm	500/10	
32-573	100.10.050	M8 - h:40mm D:Ø40mm	120/12	
02-424	12-018	M8 - h:51mm D:Ø35mm	300/10	
32-574	100.10.040	M10 - h:40mm D:Ø50mm	120/12	
32-575	100.10.030	M10 - h:50mm D:Ø55mm	120/12	
32-576	100.10.020	M10 - h:56mm D:Ø60mm	120/12	
32-577	100.10.010	M10 - h:70mm D:Ø50mm	120/12	
02-425	12-0210	M10 - h:77mm D:Ø50mm	100/10	



COD DABLEROM	COD PRODUCATOR	DENUMIRE	PAC.	PRET €
izolatori industriali				
32-581	100.13.020	M12/16 - h:130mm D:Ø70mm - 12KV	2/1	
32-582	100.13.030	M12/16 - h:210mm D:Ø77mm - 24KV	2/1	

**IZOLATORI DE CAPAT (KAPS)**

COD DABLEROM	COD PRODUCATOR	DENUMIRE	PAC.	PRET €
izolatori de capat (KAPS)				
31-300	31300	pentru cablu 1.5-2.5mm ² (pret 100buc)	100	
31-301	31301	pentru cablu 4mm ² (pret 100buc)	100	
31-302	31302	pentru cablu 6-10mm ² (pret 50buc)	100	

**BANDA SPIRALATA PENTRU LEGAT CABLURI**

COD DABLEROM	COD PRODUCATOR	DENUMIRE	PAC.	PRET €
banda spiralata pentru legat cabluri - alb transparent				
32-800	290.20.010	D:3.5mm-D1:4.5mm-l:6.5mm (pret 10m)	1	
32-801	290.20.020	D:5.5mm-D1:8mm -l:10.8mm (pret 10m)	1	
32-802	290.20.030	D:7.5mm-D1:9.5mm-l:13mm (pret 10m)	1	
32-803	290.20.040	D:10mm -D1:12mm -l:13.9mm (pret 10m)	1	
32-804	290.20.050	D:12mm -D1:13.5mm-l:15mm (pret 10m)	1	
32-805	290.20.060	D:16mm -D1:18mm -l:18.2mm (pret 10m)	1	
32-806	290.20.070	D:20mm -D1:24mm -l:19.6mm (pret 10m)	1	



PAPUCI DIN CUPRU

147

COD DABLEROM	COD PRODUCATOR	DENUMIRE (cablu/gaura/lungime)	PAC.	PRET €
papuci din cupru - tip greu				
01-500/5	12-165	6/5 - L:27mm	100	
01-500/6	12-166	6/6 - L:27mm	100	
01-500/8	12-168	6/8 - L:27mm	100	
01-501/6	12-1106	10/6 - L:30mm	100	
01-501/8	12-1108	10/8 - L:32mm	100	
01-501/10	12-11010	10/10 - L:32mm	100	
01-502/6	12-1166	16/6 - L:34mm	100	
01-502/8	12-1168	16/8 - L:34mm	100	
01-502/10	12-11610	16/10 - L:34mm	100	
01-502/12	12-11612	16/12 - L:36mm	100	
01-503/6	12-1256	25/6 - L:37mm	50	
01-503/8	12-1258	25/8 - L:37mm	50	
01-503/10	12-12510	25/10 - L:40mm	50	
01-503/12	12-12512	25/12 - L:42mm	50	
01-504/6	12-1356	35/6 - L:45mm	50	
01-504/8	12-1358	35/8 - L:45mm	50	
01-504/10	12-13510	35/10 - L:45mm	50	
01-504/12	12-13512	35/12 - L:46mm	50	
01-505/8	12-1508	50/8 - L:49mm	25	
01-505/10	12-15010	50/10 - L:49mm	25	
01-505/12	12-15012	50/12 - L:52mm	25	
01-506/8	12-17008	70/8 - L:55mm	25	
01-506/10	12-17010	70/10 - L:57mm	25	
01-506/12	12-17012	70/12 - L:57mm	25	
01-507/8	12-19508	95/8 - L:63mm	10	
01-507/10	12-19510	95/10 - L:63mm	10	
01-507/12	12-19512	95/12 - L:66mm	10	
01-507/14	12-19514	95/14 - L:66mm	10	
01-508/8	12-112008	120/8 - L:70mm	10	
01-508/10	12-112010	120/10 - L:70mm	10	
01-508/12	12-112012	120/12 - L:70mm	10	
01-508/14	12-112014	120/14 - L:73mm	10	
01-509/10	12-115010	150/10 - L:76mm	10	
01-509/12	12-115012	150/12 - L:76mm	10	
01-509/14	12-115014	150/14 - L:80mm	10	
01-509/16	12-115016	150/16 - L:80mm	10	
01-510/12	12-118512	185/12 - L:84mm	10	
01-510/14	12-118514	185/14 - L:84mm	10	
01-510/16	12-118516	185/16 - L:86mm	10	
01-510/18	12-118518	185/18 - L:86mm	10	
01-511/12	12-124012	240/12 - L:95mm	10	
01-511/14	12-124014	240/14 - L:95mm	10	
01-511/16	12-124016	240/16 - L:98mm	10	
01-511/18	12-124018	240/18 - L:98mm	10	
01-512/14	12-130014	300/14 - L:104mm	6	
01-512/16	12-130016	300/16 - L:104mm	6	
01-512/18	12-130018	300/18 - L:108mm	6	
01-512/20	12-130020	300/20 - L:104mm	6	
01-513/20	12-140020	400/20 - L:113mm	4	



CONECTORI (MUFE) DIN CUPRU

COD DABLEROM	COD PRODUCATOR	DENUMIRE (cablu/lungime)	PAC.	PRET €
conectori (mufe) din cupru - tip greu				
01-530	12-26	6 mm ² - L:27mm	100	
01-531	12-210	10 mm ² - L:30mm	100	
01-532	12-216	16 mm ² - L:34mm	100	
01-533	12-225	25 mm ² - L:37mm	50	
01-534	12-235	35 mm ² - L:45mm	50	
01-535	12-250	50 mm ² - L:49mm	30	
01-536	12-270	70 mm ² - L:55mm	10	
01-537	12-295	95 mm ² - L:63mm	10	
01-538	12-2120	120 mm ² - L:70mm	10	
01-539	12-2150	150 mm ² - L:76mm	10	
01-540	12-2185	185 mm ² - L:84mm	10	
01-541	12-2240	240 mm ² - L:95mm	10	
01-542	12-2300	300 mm ² - L:104mm	6	

**PAPUCI**

COD DABLEROM	COD PRODUCATOR	DENUMIRE (culoare/deschidere/cablu)	PAC.	PRET €
papuci izolati - inel				
01-400	12-502153	rosu - 3mm - 1.5mm ² - (pret la 100buc)	1	
01-401	12-502154	rosu - 4mm - 1.5mm ² - (pret la 100buc)	1	
01-402	12-502155	rosu - 5mm - 1.5mm ² - (pret la 100buc)	1	
01-403	12-502156	rosu - 6mm - 1.5mm ² - (pret la 100buc)	1	
01-404	12-504253	albastru -3mm -2.5mm ² -(pret la 100buc)	1	
01-405	12-504254	albastru -4mm -2.5mm ² -(pret la 100buc)	1	
01-406	12-504255	albastru -5mm -2.5mm ² -(pret la 100buc)	1	
01-407	12-504256	albastru -6mm -2.5mm ² -(pret la 100buc)	1	
01-408	12-504258	albastru -8mm -2.5mm ² -(pret la 100buc)	1	
01-410	12-50364	galben -4mm -6mm ² -(pret la 100buc)	1	
01-411	12-50365	galben -5mm -6mm ² -(pret la 100buc)	1	
01-412	12-50366	galben -6mm -6mm ² -(pret la 100buc)	1	
01-413	12-50368	galben -8mm -6mm ² -(pret la 100buc)	1	
01-414	12-503610	galben -10mm -6mm ² -(pret la 100buc)	1	



papuci izolati - furca				
01-415	12-512153	rosu - 3mm - 1.5mm ² - (pret la 100buc)	1	
01-416	12-512154	rosu - 4mm - 1.5mm ² - (pret la 100buc)	1	
01-417	12-512155	rosu - 5mm - 1.5mm ² - (pret la 100buc)	1	
01-419	12-514253	albastru -3mm -2.5mm ² -(pret la 100buc)	1	
01-420	12-514254	albastru -4mm -2.5mm ² -(pret la 100buc)	1	
01-421	12-514255	albastru -5mm -2.5mm ² -(pret la 100buc)	1	
01-422	12-514256	albastru -6mm -2.5mm ² -(pret la 100buc)	1	
01-423	12-51363	galben -3mm -6mm ² -(pret la 100buc)	1	
01-424	12-51364	galben -4mm -6mm ² -(pret la 100buc)	1	
01-425	12-51365	galben -5mm -6mm ² -(pret la 100buc)	1	
01-426	12-51366	galben -6mm -6mm ² -(pret la 100buc)	1	



papuci neizolati - auto				
01-474	12-520361	tata - 4.8mm - 6mm ² - (pret la 100buc)	1	
01-475	12-520360	tata - 6.35mm - 6mm ² - (pret la 100buc)	1	
01-476	12-521361	mama -4.8mm -6mm ² - (pret la 100buc)	1	
01-477	12-521360	mama -6.35mm -6mm ² - (pret la 100buc)	1	



PAPUCI IZOLATI

149

COD DABLEROM	COD PRODUCATOR	DENUMIRE (culoare/cablu)	PAC.	PRET €
papuci izolati - pin				
01-436	12-55005	alb - 0.5 mm ² - (pret la 100buc)	1	
01-437	12-554075	albastru - 0.75 mm ² - (pret la 100buc)	1	
01-438	12-5521	rosu - 1 mm ² - (pret la 100buc)	1	
01-439	12-55115	negru - 1.5 mm ² - (pret la 100buc)	1	
01-440	12-55625	gri - 2.5 mm ² - (pret la 100buc)	1	
01-441	12-5584	portocaliu - 4 mm ² - (pret la 100buc)	1	
01-442	12-5556	verde - 6 mm ² - (pret la 100buc)	1	
01-443	12-55710	maro - 10 mm ² - (pret la 100buc)	1	
01-444	12-55916	bej - 16 mm ² - (pret la 100buc)	1	
01-445	12-55125	negru - 25 mm ² - (pret la 100buc)	1	
01-446	12-55235	rosu - 35 mm ² - (pret la 100buc)	1	
01-447	12-55450	albastru - 50 mm ² - (pret la 100buc)	1	



papuci izolati - pin infasurat				
01-459	12-54215	rosu - 1.5 mm ² - (pret la 100buc)	1	
01-460	12-54425	albastru - 2.5 mm ² - (pret la 100buc)	1	
01-461	12-5466	galben - 6 mm ² - (pret la 100buc)	1	



papuci izolati - tip conector (mufa)				
01-462	12-53215	rosu - 1.5 mm ² - (pret la 100buc)	1	
01-463	12-53425	albastru - 2.5 mm ² - (pret la 100buc)	1	
01-464	12-5366	galben - 6 mm ² - (pret la 100buc)	1	



papuci izolati - sferic				
01-427	12-560215	tata-rosu - 1.5mm ² - (pret la 100buc)	1	
01-428	12-560425	tata-albastru - 2.5mm ² - (pret la 100buc)	1	
01-429	12-56036	tata-galben - 6mm ² - (pret la 100buc)	1	
01-430	12-561215	mama-rosu - 1.5mm ² - (pret la 100buc)	1	
01-431	12-561425	mama-albastru - 2.5mm ² - (pret la 100buc)	1	
01-432	12-56136	mama-galben - 6mm ² - (pret la 100buc)	1	



papuci izolati - auto (deschidere de 6.35mm)				
01-465	12-520215	tata-rosu - 1.5mm ² - (pret la 100buc)	1	
01-466	12-520425	tata-albastru - 2.5mm ² - (pret la 100buc)	1	
01-467	12-52036	tata-galben - 6mm ² - (pret la 100buc)	1	
01-468	12-521215	mama-rosu - 1.5mm ² - (pret la 100buc)	1	
01-469	12-521425	mama-albastru - 2.5mm ² - (pret la 100buc)	1	
01-470	12-52136	mama-galben - 6mm ² - (pret la 100buc)	1	



papuci izolati - auto mama (deschidere de 6.35mm) - izolat complet				
01-471	12-571215	mama-rosu - 1.5mm ² - (pret la 100buc)	1	
01-472	12-571425	mama-albastru - 2.5mm ² - (pret la 100buc)	1	
01-473	12-57136	mama-galben - 6mm ² - (pret la 100buc)	1	



papuci izolati - auto mama+tata (deschidere de 6.35mm)				
01-433	12-58215	rosu - 1.5mm ² - (pret la 100buc)	1	
01-434	12-58425	albastru - 2.5mm ² - (pret la 100buc)	1	
01-435	12-5836	galben - 6mm ² - (pret la 100buc)	1	



COLIERE (FASETE) DIN NYLON 66

COD DABLEROM	COD PRODUCATOR	DENUMIRE	PAC.	PRET €
coliere (fasete) din NYLON 66				
01-600	19-100250	100x2.5mm - albe - (pret la 100buc)	100	
01-601	19-100251	100x2.5mm - negre - (pret la 100buc)	100	
01-602	19-120250	120x2.5mm - albe - (pret la 100buc)	100	
01-603	19-120251	120x2.5mm - negre - (pret la 100buc)	100	
01-604	19-142250	142x2.5mm - albe - (pret la 100buc)	100	
01-605	19-142251	142x2.5mm - negre - (pret la 100buc)	100	
01-606	19-165250	165x2.5mm - albe - (pret la 100buc)	100	
01-607	19-165251	165x2.5mm - negre - (pret la 100buc)	100	
01-608	19-200250	200x2.5mm - albe - (pret la 100buc)	100	
01-609	19-200251	200x2.5mm - negre - (pret la 100buc)	100	
01-610	19-150360	150x3.6mm - albe - (pret la 100buc)	100	
01-611	19-150361	150x3.6mm - negre - (pret la 100buc)	100	
01-612	19-200360	200x3.6mm - albe - (pret la 100buc)	100	
01-613	19-200361	200x3.6mm - negre - (pret la 100buc)	100	
01-614	19-250360	250x3.6mm - albe - (pret la 100buc)	100	
01-615	19-250361	250x3.6mm - negre - (pret la 100buc)	100	
01-616	19-292360	292x3.6mm - albe - (pret la 100buc)	100	
01-617	19-292361	292x3.6mm - negre - (pret la 100buc)	100	
01-618	19-330360	330x3.6mm - albe - (pret la 100buc)	100	
01-619	19-330361	330x3.6mm - negre - (pret la 100buc)	100	
01-620	19-368360	368x3.6mm - albe - (pret la 100buc)	100	
01-621	19-368361	368x3.6mm - negre - (pret la 100buc)	100	
01-622	19-200480	200x4.8mm - albe - (pret la 100buc)	100	
01-623	19-200481	200x4.8mm - negre - (pret la 100buc)	100	
01-624	19-250480	250x4.8mm - albe - (pret la 100buc)	100	
01-625	19-250481	250x4.8mm - negre - (pret la 100buc)	100	
01-626	19-310480	310x4.8mm - albe - (pret la 100buc)	100	
01-627	19-310481	310x4.8mm - negre - (pret la 100buc)	100	
01-628	19-368480	368x4.8mm - albe - (pret la 100buc)	100	
01-629	19-368481	368x4.8mm - negre - (pret la 100buc)	100	
01-630	19-432480	432x4.8mm - albe - (pret la 100buc)	100	
01-631	19-432481	432x4.8mm - negre - (pret la 100buc)	100	
01-632	19-200760	200x7.6mm - albe - (pret la 100buc)	100	
01-633	19-200761	200x7.6mm - negre - (pret la 100buc)	100	
01-634	19-250760	250x7.6mm - albe - (pret la 100buc)	100	
01-635	19-250761	250x7.6mm - negre - (pret la 100buc)	100	
01-636	19-300760	300x7.6mm - albe - (pret la 100buc)	100	
01-637	19-300761	300x7.6mm - negre - (pret la 100buc)	100	
01-638	19-45090	450x8mm - albe - (pret la 100buc)	100	
01-639	19-45091	450x8mm - negre - (pret la 100buc)	100	
01-644	19-55090	550x8mm - albe - (pret la 100buc)	100	
01-645	19-55091	550x8mm - negre - (pret la 100buc)	100	
01-646	19-65090	685x9mm - albe - (pret la 100buc)	100	
01-647	19-65091	685x9mm - negre - (pret la 100buc)	100	
01-650	19-76290	762x9mm - albe - (pret la 100buc)	100	
01-651	19-76291	762x9mm - negre - (pret la 100buc)	100	
01-654	19-91490	914x9mm - albe - (pret la 100buc)	100	
01-655	19-91491	914x9mm - negre - (pret la 100buc)	101	



COLIERE (FASETE) DIN NYLON 66

COD DABLEROM	COD PRODUCATOR	DENUMIRE	PAC.	PRET €
coliere (fasete) din NYLON 66				
01-657	19-120253	120x2.5mm - galbene - (pret la 100buc)	100	
01-659	19-120255	120x2.5mm - verde - (pret la 100buc)	100	



151

BAZA AUTOCOLANTA

COD DABLEROM	COD PRODUCATOR	DENUMIRE	PAC.	PRET €
baza autocolanta pentru coliere				
01-664	19-21210	21x21mm - albe - (pret la 100buc)	100	
01-666	19-28280	28x28mm - albe - (pret la 100buc)	100	



DIBLURI PENTRU BETON

COD DABLEROM	COD PRODUCATOR	DENUMIRE	PAC.	PRET €
dibluri pentru beton (fara surub)				
07-100	07100	6mm	100	
07-103	07103	10mm	100	
07-104	07104	12mm	100	
07-105	07105	14mm	100	



DIBLURI SPECIALE (gips-carton, caramida, etc)

COD DABLEROM	COD PRODUCATOR	DENUMIRE	PAC.	PRET €
dibluri pentru gips-carton, caramida etc				
07-920	1-0640	dibluri 6x40mm	200	



BANDA SUPORT

COD DABLEROM	COD PRODUCATOR	DENUMIRE	PAC.	PRET €
banda suport din metal in cutie din plastic				
01-671	1-5	lat.:12mm/gr.:0.7mm/ø5mm (pret:10m)	20	
01-672	1-51	lat.:17mm/gr.:0.8mm/ø6mm (pret:10m)	20	
01-673	1-55	lat.:25mm/gr.:0.8mm/ø8mm (pret:10m)	20	



SARMA TRAS CABLU

COD DABLEROM	COD PRODUCATOR	DENUMIRE	PAC.	PRET €
sarma tras cablu din NYLON rotund - Ø:3mm				
38-300	915-90454	5 metri	10	
38-301	915-904104	10 metri	10	
38-302	915-904204	15 metri	10	
38-303	915-90420	20 metri	10	



sarma tras cablu din METAL plat - 3.2mm

38-305/5	915-9135	5 metri	10	
38-305/10	915-91310	10 metri	10	
38-305/15	915-91315	15 metri	10	



sarma tras cablu din METAL spiral

38-306/10	915-911410	10 metri - Ø3.8mm	10	
38-306/30	915-911430	30 metri - Ø3.8mm	10	
38-307/20	915-911520	20 metri - Ø5.5mm	10	
38-307/30	915-911530	30 metri - Ø5.5mm	10	



februarie 2012

CLIPS CUI DIN OTEL

152

COD DABLEROM	COD PRODUCATOR	DENUMIRE(cablu/cui mm)	PAC.	PRET €
clips cui din otel - plat				
07-000	07000	4/20	100	
07-001	07001	5/20	100	



COD DABLEROM	COD PRODUCATOR	DENUMIRE(cablu/cui mm)	PAC.	PRET €
clips cui din otel - rotund				
07-002	07002	4/20	100	
07-003	07003	5/20	100	
07-004	07004	6/25	100	
07-005	07005	7/25	100	
07-006	07006	8/25	100	
07-007	07007	9/25	100	
07-008	07008	10/25	100	
07-009	07009	11/25	100	
07-010	07010	12/25	100	
07-011	07011	13/25	100	
07-012	07012	14/25	100	
07-013	07013	6/35	100	
07-014	07014	7/35	100	
07-015	07015	8/35	100	
07-016	07016	9/35	100	
07-017	07017	10/35	100	
07-018	07018	11/35	100	
07-019	07019	12/35	100	
07-020	07020	13/35	100	
07-021	07021	14/35	100	
07-022	07022	15/35	100	
07-023	07023	16/35	100	
07-024	07024	17/35	100	
07-026	07026	7/45	100	
07-027	07027	8/45	100	
07-028	07028	9/45	100	
07-029	07029	10/45	100	
07-030	07030	11/45	100	
07-031	07031	12/45	100	
07-032	07032	13/45	100	
07-033	07033	14/45	100	
07-034	07034	15/45	100	
07-035	07035	16/45	100	
07-036	07036	17/45	100	
07-037	07037	19/50	50	
07-038	07038	22/50	50	



ETICHETE DIN PLASTIC PENTRU TABLOURI

153

COD DABLEROM	COD PRODUCATOR	DENUMIRE	PAC.	PRET €
etichete din plastic pentru tablouri cu protectie transparenta				
32-697	302.10.010	51x14mm	10	
32-698	302.10.020	60x20mm	10	
32-699	302.10.030	80x26mm	10	



MARCAJE PENTRU CABLU TIP INEL

COD DABLEROM	COD PRODUCATOR	DENUMIRE	PAC.	PRET €
marcaje pentru cablu tip inel - culoare:galben - 1000buc/rola - pret la rola				
32-600...32-609	200.24.*	cifra:0...9 pentru cablu 0.5-1.5mm	10	
32-610...32-619	200.20.*	cifra:0...9 pentru cablu 2.5-6mm	10	
32-620...32-645	200.24.*	litera:A...Z pentru cablu 2.5-6mm	10	

la comanda se va specifica cifra sau litera dorita



MARCAJE PENTRU CABLU TIP CLIPS

COD DABLEROM	COD PRODUCATOR	DENUMIRE	PAC.	PRET €
marcaje pentru cablu tip clips - 30buc/pachet - pret la pachet				
32-690/...	200.34.*	cifra:0...9 - L:3mm Ø1:2.5mm Ø2:4mm	1	
32-691/...	200.36.*	cifra:0...9 - L:3mm Ø1:3.2mm Ø2:4.6mm	1	
32-692/...	200.38.*	cifra:0...9 - L:3mm Ø1:4.2mm Ø2:6mm	1	
32-693/...	200.40.*	litera:A...Z - L:3mm Ø1:2.5mm Ø2:4mm	1	
32-694/...	200.42.*	litera:A...Z - L:3mm Ø1:3.2mm Ø2:4.6mm	1	
32-695/...	200.44.*	litera:A...Z - L:3mm Ø1:4.2mm Ø2:6mm	1	

la comanda se va specifica cifra sau litera dorita

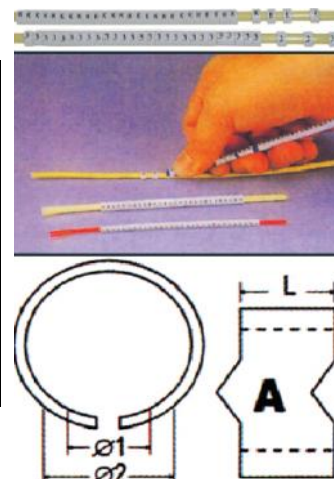

MARCAJE AUTOCOLANTE

COD DABLEROM	COD PRODUCATOR	DENUMIRE	PAC.	PRET €
marcaje autocolante - 6x5mm/buc - 80buc/pachet - pret la pachet				
32-650...32-659	200.26.*	cifra:0...9	50	
32-660...32-686	200.28.*	litera:A...Z	50	

la comanda se va specifica cifra sau litera dorita

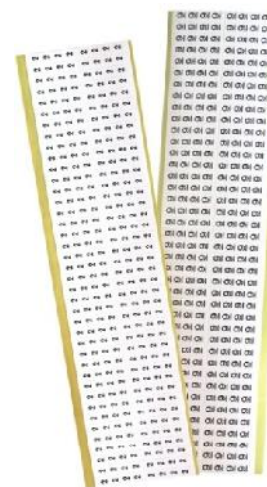

BANDA IZOLATOARE DIN CAUCIUC TERMOCONTRACTIBILA

COD DABLEROM	COD PRODUCATOR	DENUMIRE	PAC.	PRET €
banda izolatoare din cauciuc termocontractibila				
01-670	9-1011	lungime:10metri / latime:20mm	100	



154

TUBURI TERMOCONTRACTIBILE 2:1

COD DABLEROM	COD PRODUCATOR	DENUMIRE (mm inainte/dupa contractie)	PAC.	PRET €
tuburi termocontractibile - raport de contractie 2:1 - rola la 10 metri - pret la metru				
32-850	040.10.010...060	4 / 2mm	100	
32-851	040.10.070...120	5 / 2.5mm	100	
32-852	040.10.130...180	7 / 3.5mm	100	
32-853	040.10.190...240	10 / 5mm	100	
32-854	040.10.250...300	13 / 6.5mm	100	
32-855	040.10.310...360	25 / 12.5mm	50	
32-856	040.10.370...420	40 / 20mm	25	
32-857	040.10.430...480	50 / 25mm	25	
32-858	040.10.490...540	80 / 40mm	25	
32-859	040.10.550...600	100 / 50mm	25	
<i>culori disponibile: negru / maro / gri / albastru / galben / rosu</i>				
<i>la comanda se va specifica culoarea dorita</i>				



TUBURI TERMOCONTRACTIBILE 4:1 - GT

COD DABLEROM	COD PRODUCATOR	DENUMIRE (mm inainte/dupa contractie)	PAC.	PRET €
tuburi termocontractibile - raport de contractie 4:1 - pret la metru				
32-890	038.55.010	12 / 3mm	1	
32-891	038.55.020	20 / 6mm	1	
32-892	038.55.030	28 / 6mm	1	
32-893	038.55.040	31 / 8mm	1	
32-894	038.55.050	38 / 10mm	1	
32-895	038.55.060	48 / 15mm	1	
32-896	038.55.070	75 / 23mm	1	
32-897	038.55.080	90 / 29mm	1	
32-898	038.55.090	120 / 36mm	1	



SET MUFE TERMOCONTRACTIBILE 1KV CU ADEZIV - GT

COD DABLEROM	COD PRODUCATOR	DENUMIRE (mm inainte/dupa contractie)	PAC.	PRET €
set tuburi termocontractibile cu adeziv				
32-880	038.60.010	min.5x1.5mm ² max.5x6mm ² (5int+1ext)	1	
32-881	038.60.020	min.5x1.5mm ² max.5x16mm ² (5int+1ext)	1	
32-882	038.60.030	min.5x16mm ² max.5x25mm ² (5int+1ext)	1	
32-883	038.60.040	min.4x6mm ² max.4x25mm ² (4int+1ext)	1	
32-884	038.60.050	min.4x16mm ² max.4x50mm ² (4int+1ext)	1	
32-885	038.60.060	min.4x25mm ² max.4x95mm ² (4int+1ext)	1	
32-886	038.60.070	min.4x35mm ² max.4x150mm ² (4int+1ext)	1	
32-887	038.60.080	min.4x70mm ² max.4x150mm ² (4int+1ext)	1	
32-888	038.60.090	min.4x95mm ² max.4x300mm ² (4int+1ext)	1	



MANSOANE LINIARE 1KV - GT

COD DABLEROM	COD PRODUCATOR	DENUMIRE	PAC.	PRET €
manson liniar 1KV cu rasina				
32-860	038.10.060	cablu 6-19mm sau max.5x2.5mm ²	1	
32-861	038.10.070	cablu 6-25mm sau max.5x6mm ²	1	
32-862	038.10.080	cablu 14-35mm sau max.4x16mm ²	1	
32-863	038.10.090	cablu 16-37mm sau max.4x25mm ²	1	
32-864	038.10.100	cablu 20-44mm sau max.4x50mm ²	1	
32-865	038.10.110	cablu 26-52mm sau max.4x95mm ²	1	
32-866	038.10.120	cablu 35-65mm sau max.4x150mm ²	1	
32-867	038.10.130	cablu 45-80mm sau max.4x240mm ²	1	
32-868	038.10.140	cablu 50-90mm sau max.4x300mm ²	1	

**MANSOANE RAMIFICATIE "T" 1KV - GT**

COD DABLEROM	COD PRODUCATOR	DENUMIRE	PAC.	PRET €
manson ramificatie "T" 1KV cu rasina				
32-870	038.20.010	cablu 14-35mm / 5x1.5mm ² -5x10mm ²	1	
32-871	038.20.020	cablu 16-35mm / 5x6mm ² -5x16mm ²	1	

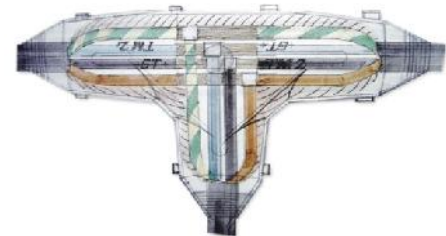
**RASINI PENTRU MANSOANE 1KV - GT**

COD DABLEROM	COD PRODUCATOR	DENUMIRE	PAC.	PRET €
rasina pentru manson 1KV				
32-875/100	038.25.010	100 ml / 165gr	1	
32-875/170	038.25.020	170 ml / 255gr	1	
32-875/360	038.25.030	360 ml / 520gr	1	
32-875/470	038.25.040	470 ml / 685gr	1	
32-875/800	038.25.050	800 ml / 1320gr	1	
32-875/1800	038.25.060	1800 ml / 2970gr	1	
32-875/2000	038.25.070	2000 ml / 3300gr	1	



CABLURI

156

COD DABLEROM	COD PRODUCATOR	DENUMIRE	PAC.	PRET €
cablu retea				
01-385	9-621046	UTP 4x2x24AWG - cat.5e	305	
01-387	9-621243	UTP 4x2x24AWG - cat.6	305	
01-386/5e	9-621146	FTP 4x2x24AWG - cat.5e	305	
01-386/6	9-621143	FTP 4x2x24AWG - cat.6	305	



cablu TV - satelit				
01-388	9-02161	cablu coaxial TV 75Ω alb	100	
01-389	9-02163	cablu satelit RG6U Al-Al (alum.-alum.)	100	
01-391	9-02165	cablu satelit RG6U Cu-Cu (cupru-cupru)	100	



cablu telefonic - plat - 2 perechi				
01-214	9-2040	cablu telefonic plat 2 perechi - alb	100	
01-215	9-2041	cablu telefonic plat 2 perechi - negru	100	



cablu telefonic unifilar - culoare:gri - cu ecranaj aluminiu - infasurare la perechi				
01-365	9-221116	1 pereche - 0.6mm	100	
01-366	9-221126	2 perechi - 0.6mm	100	
01-367	9-221136	3 perechi - 0.6mm	100	
01-368	9-221146	4 perechi - 0.6mm	100	
01-369	9-221156	5 perechi - 0.6mm	100	
01-370	9-221186	8 perechi - 0.6mm	100	
01-371	9-2211106	10 perechi - 0.6mm	100	
01-372	9-2211156	15 perechi - 0.6mm	100	



cablu siliconic monofilar				
01-338/...	9-101*	1 mm ²	100	
01-339/...	9-115*	1.5 mm ²	100	
01-340/...	9-125*	2.5 mm ²	100	
01-341/...	9-104*	4 mm ²	100	
01-342/...	9-106*	6 mm ²	100	
01-343/...	9-110*	10 mm ²	100	
<i>culori disponibile: alb / negru / rosu / galben / albastru / verde / maro</i>				
<i>la comanda se va specifica culoarea dorita</i>				

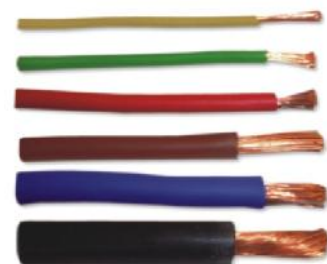

cablu siliconic multifilar				
01-344	9-121	2 x 1 mm ²	100	
01-345	9-1215	2 x 1.5 mm ²	100	
01-346	9-1225	2 x 2.5 mm ²	100	
01-347	9-131	3 x 1 mm ²	100	
01-348	9-1315	3 x 1.5 mm ²	100	
01-349	9-1325	3 x 2.5 mm ²	100	
01-350	9-1415	4 x 1.5 mm ²	100	
01-351	9-1425	4 x 2.5 mm ²	100	



COPEX METALIC

157

COD DABLEROM	COD PRODUCATOR	DENUMIRE	PAC.	PRET €
copex metalic galvanizat				
02-891	1-10	interior Ø: 10mm - exterior Ø: 12mm	100	
02-892	1-12	interior Ø: 12mm - exterior Ø: 15mm	100	
02-893	1-14	interior Ø: 14mm - exterior Ø: 17mm	100	
02-894	1-16	interior Ø: 16mm - exterior Ø: 20mm	50	
02-895	1-18	interior Ø: 18mm - exterior Ø: 22mm	50	
02-896	1-20	interior Ø: 20mm - exterior Ø: 24mm	50	
02-897	1-22	interior Ø: 22mm - exterior Ø: 26mm	30	
02-898	1-25	interior Ø: 25mm - exterior Ø: 30mm	30	
02-899	1-30	interior Ø: 30mm - exterior Ø: 35mm	30	
02-900	1-35	interior Ø: 35mm - exterior Ø: 41mm	20	
02-901	1-45	interior Ø: 45mm - exterior Ø: 52mm	20	



copex metalic galvanizat cu izolatie PVC				
02-902	1-010	interior Ø: 10mm - exterior Ø: 12mm	100	
02-903	1-012	interior Ø: 12mm - exterior Ø: 15mm	100	
02-904	1-014	interior Ø: 14mm - exterior Ø: 17mm	50	
02-905	1-016	interior Ø: 16mm - exterior Ø: 20mm	50	
02-906	1-018	interior Ø: 18mm - exterior Ø: 22mm	50	
02-907	1-020	interior Ø: 20mm - exterior Ø: 24mm	50	
02-908	1-022	interior Ø: 22mm - exterior Ø: 26mm	50	
02-909	1-025	interior Ø: 25mm - exterior Ø: 30mm	50	
02-910	1-030	interior Ø: 30mm - exterior Ø: 35mm	25	
02-911	1-035	interior Ø: 35mm - exterior Ø: 41mm	25	
02-912	1-045	interior Ø: 45mm - exterior Ø: 52mm	20	



TUB RIGID/FLEXIBIL RIFLAT SUB TENCUIALA



COD DABLEROM	COD PRODUCATOR	DENUMIRE	PAC.	PRET €
tub rigid - culoare:albastru - "SUPERSOL" - de tip usor 320Nt				
23-1411011	1411011	interior Ø: 9.2mm - exterior Ø: 10.8mm	60	
23-1411013	1411013	interior Ø: 12.6mm - exterior Ø: 14.3mm	60	
23-1411016	1411016	interior Ø: 15mm - exterior Ø: 16.8mm	60	
23-1411023	1411023	interior Ø: 21.2mm - exterior Ø: 23.1mm	25	
23-1411029	1411029	interior Ø: 26.8mm - exterior Ø: 28.8mm	25	



tub flexibil riflat - culoare:albastru - "SUPERFLEX" - de tip usor 320Nt				
23-2011011	2011011	interior Ø: 11.1mm - exterior Ø: 16mm	50	
23-2011013	2011013	interior Ø: 14.4mm - exterior Ø: 18.6mm	50	
23-2011016	2011016	interior Ø: 17.1mm - exterior Ø: 21.2mm	50	
23-2011023	2011023	interior Ø: 23.4mm - exterior Ø: 28.2mm	25	
23-2011029	2011029	interior Ø: 29.2mm - exterior Ø: 34.1mm	20	



tub flexibil riflat - culoare:albastru - "DUROFLEX" - de tip mediu 750Nt				
23-2021011	2021011	interior Ø: 11.3mm - exterior Ø: 16mm	50	
23-2021013	2021013	interior Ø: 14.3mm - exterior Ø: 18.7mm	50	
23-2021016	2021016	interior Ø: 16.5mm - exterior Ø: 21.2mm	50	
23-2021023	2021023	interior Ø: 23.3mm - exterior Ø: 28.5mm	25	
23-2021029	2021029	interior Ø: 29mm - exterior Ø: 34.5mm	20	



februarie 2012

COD DABLEROM	COD PRODUCATOR	DENUMIRE	PAC.	PRET €
tub rigid - culoare:gri - "SILCOR" - de tip usor 320Nt				
23-1015016	1015016	interior Ø: 14.1mm - exterior Ø: 16mm	90	
23-1015020	1015020	interior Ø: 18.2mm - exterior Ø: 20mm	60	
23-1015025	1015025	interior Ø: 22.9mm - exterior Ø: 25mm	45	
23-1015032	1015032	interior Ø: 29.6mm - exterior Ø: 32mm	30	



tub flexibil riflat - culoare:gri - "SIFLEX" - de tip usor 320Nt				
23-2015016	2015016	interior Ø: 11.1mm - exterior Ø: 16mm	50	
23-2015020	2015020	interior Ø: 14.8mm - exterior Ø: 20mm	50	
23-2015025	2015025	interior Ø: 18.9mm - exterior Ø: 25mm	25	
23-2015032	2015032	interior Ø: 24.6mm - exterior Ø: 32mm	25	
23-2015040	2015040	interior Ø: 31.6mm - exterior Ø: 40mm	20	
23-2015050	2015050	interior Ø: 39.8mm - exterior Ø: 50mm	20	
23-2015063	2015063	interior Ø: 52.8mm - exterior Ø: 63mm	20	



doze - culoare:gri - "CONDUR HF" - IP65				
23-3020416	3020416	67x67x38mm	10	
23-3020420	3020420	82x82x43mm	10	
23-3020425	3020425	101x101x51mm	5	



cot "SILCOR" - culoare:gri				
23-4315016	4315016	cot Ø16	40	
23-4315020	4315020	cot Ø20	40	
23-4315025	4315025	cot Ø25	20	
23-4315032	4315032	cot Ø32	9	



mufa "SILCOR" - culoare:gri				
23-4215016	4215016	mufa Ø16	50	
23-4215020	4215020	mufa Ø20	50	
23-4215025	4215025	mufa Ø25	40	
23-4215032	4215032	mufa Ø32	30	
23-4215040	4215040	mufa Ø40	20	
23-4215050	4215050	mufa Ø50	10	
23-4215063	4215063	mufa Ø63	8	



clema "CONDUR" - culoare:gri				
23-4125016	4125016	clema Ø16	50	
23-4125020	4125020	clema Ø20	50	
23-4125025	4125025	clema Ø25	30	
23-4125032	4125032	clema Ø32	30	
23-4125040	4125040	clema Ø40	20	
23-4125050	4125050	clema Ø50	20	
23-4125063	4125063	clema Ø63	20	



racord "CONDUR" - culoare:gri				
23-4025016	4025016	racord Ø16	30	
23-4025020	4025020	racord Ø20	30	
23-4025225	4025225	racord Ø25	20	
23-4025232	4025232	racord Ø32	20	



TUB RIGID/FLEXIBIL RIFLAT PE TENCUIALA DE TIP MEDIU 750nt

COD DABLEROM	COD PRODUCATOR	DENUMIRE	PAC.	PRET €
tub rigid - culoare:alb - "MEDISOL" - de tip mediu 750nt				
23-1034016	1034016	interior Ø: 13.2mm - exterior Ø: 16mm	30	
23-1034020	1034020	interior Ø: 16.8mm - exterior Ø: 20mm	30	
23-1034025	1034025	interior Ø: 22mm - exterior Ø: 25mm	30	
23-1034032	1034032	interior Ø: 28.7mm - exterior Ø: 32mm	15	
23-1034040	1034040	interior Ø: 36.3mm - exterior Ø: 40mm	9	
23-1034050	1034050	interior Ø: 45.8mm - exterior Ø: 50mm	9	
23-1034063	1034063	interior Ø: 58.4mm - exterior Ø: 63mm	9	



tub flexibil riflat - culoare:alb - "MEDIFLEX" - de tip mediu 750nt				
23-2034016	2034016	interior Ø: 10.9mm - exterior Ø: 16mm	50	
23-2034020	2034020	interior Ø: 14.3mm - exterior Ø: 20mm	50	
23-2034025	2034025	interior Ø: 18.6mm - exterior Ø: 25mm	25	
23-2034032	2034032	interior Ø: 24.4mm - exterior Ø: 32mm	25	
23-2034040	2034040	interior Ø: 31.3mm - exterior Ø: 40mm	20	
23-2034050	2034050	interior Ø: 39.3mm - exterior Ø: 50mm	20	
23-2034063	2034063	interior Ø: 52.1mm - exterior Ø: 63mm	20	



doze - culoare:alb - "MEDISOL" - IP65				
23-3034016	3034016	67x67x38mm	10	
23-3034020	3034020	82x82x43mm	10	
23-3034025	3034025	101x101x51mm	5	



cot "MEDISOL" - culoare:alb				
23-4334016	4334016	cot Ø16	10	
23-4334020	4334020	cot Ø20	10	
23-4334025	4334025	cot Ø25	10	
23-4334032	4334032	cot Ø32	6	
23-4334040	4334040	cot Ø40	6	
23-4334050	4334050	cot Ø50	4	
23-4334063	4334063	cot Ø63	4	



mufa "MEDISOL" - culoare:alb				
23-4234016	4234016	mufa Ø16	30	
23-4234020	4234020	mufa Ø20	30	
23-4234025	4234025	mufa Ø25	30	
23-4234032	4234032	mufa Ø32	20	
23-4234040	4234040	mufa Ø40	15	
23-4234050	4234050	mufa Ø50	10	
23-4234063	4234063	mufa Ø63	8	



clema "MEDISOL" - culoare:alb				
23-4134016	4134016	clema Ø16	50	
23-4134020	4134020	clema Ø20	50	
23-4134025	4134025	clema Ø25	30	
23-4134032	4134032	clema Ø32	30	
23-4134040	4134040	clema Ø40	20	
23-4134050	4134050	clema Ø50	20	
23-4134063	4134063	clema Ø63	20	



racord "MEDISOL" - culoare:alb				
23-4034016	4034016	racord Ø16	30	
23-4034020	4034020	racord Ø20	30	
23-4034025	4034025	racord Ø25	20	
23-4034032	4034032	racord Ø32	20	



TUB RIGID/FLEXIBIL RIFLAT PE TENCUIALA DE TIP GREU 1250nt

COD DABLEROM	COD PRODUCATOR	DENUMIRE	PAC.	PRET €
tub rigid - culoare:gri - "CONDUR" - de tip greu 1250nt				
23-1025016	1025016	interior Ø: 12.6mm - exterior Ø: 16mm	30	
23-1025020	1025020	interior Ø: 16.4mm - exterior Ø: 20mm	30	
23-1025025	1025025	interior Ø: 21.2mm - exterior Ø: 25mm	15	
23-1025032	1025032	interior Ø: 27.7mm - exterior Ø: 32mm	15	
23-1025040	1025040	interior Ø: 35.6mm - exterior Ø: 40mm	9	
23-1025050	1025050	interior Ø: 45.1mm - exterior Ø: 50mm	9	
23-1025063	1025063	interior Ø: 56.7mm - exterior Ø: 63mm	9	



tub flexibil riflat - culoare:gri - "CONFLEX" - de tip greu 1250nt				
23-2025016	2025016	interior Ø: 10.8mm - exterior Ø: 16mm	50	
23-2025020	2025020	interior Ø: 14mm - exterior Ø: 20mm	50	
23-2025025	2025025	interior Ø: 18.2mm - exterior Ø: 25mm	25	
23-2025032	2025032	interior Ø: 24.1mm - exterior Ø: 32mm	25	
23-2025040	2025040	interior Ø: 30.9mm - exterior Ø: 40mm	20	
23-2025050	2025050	interior Ø: 39.2mm - exterior Ø: 50mm	20	
23-2025063	2025063	interior Ø: 52mm - exterior Ø: 63mm	20	



doze - culoare:gri - "CONDUR" - IP65				
23-3020016	3020016	67x67x38mm	10	
23-3020020	3020020	82x82x43mm	10	
23-3020225	3020225	101x101x51mm	5	



cot "CONDUR" - culoare:gri				
23-4325016	4325016	cot Ø16	10	
23-4325020	4325020	cot Ø20	10	
23-4325025	4325025	cot Ø25	10	
23-4325032	4325032	cot Ø32	6	
23-4325040	4325040	cot Ø40	6	
23-4325050	4325050	cot Ø50	4	
23-4325063	4325063	cot Ø63	4	



mufa "CONDUR" - culoare:gri				
23-4225016	4225016	mufa Ø16	30	
23-4225020	4225020	mufa Ø20	30	
23-4225025	4225025	mufa Ø25	30	
23-4225032	4225032	mufa Ø32	20	
23-4225040	4225040	mufa Ø40	15	
23-4225050	4225050	mufa Ø50	10	
23-4225063	4225063	mufa Ø63	8	



clema "CONDUR" - culoare:gri				
23-4125016	4125016	clema Ø16	50	
23-4125020	4125020	clema Ø20	50	
23-4125025	4125025	clema Ø25	30	
23-4125032	4125032	clema Ø32	30	
23-4125040	4125040	clema Ø40	20	
23-4125050	4125050	clema Ø50	20	
23-4125063	4125063	clema Ø63	20	



racord "CONDUR" - culoare:gri				
23-4025016	4025016	racord Ø16	30	
23-4025020	4025020	racord Ø20	30	
23-4025225	4025225	racord Ø25	20	
23-4025232	4025232	racord Ø32	20	



TUB RIGID/FLEXIBIL RIFLAT PE TENCUIALA "HALOGEN FREE" 1250Nt

161



COD DABLEROM	COD PRODUCATOR	DENUMIRE	PAC.	PRET €
tub rigid - culoare:gri - "CONDUR HF" - HALOGEN FREE - de tip greu 1250Nt				
23-1525016	1525016	interior Ø: 12.9mm - exterior Ø: 16mm	30	
23-1525020	1525020	interior Ø: 16.8mm - exterior Ø: 20mm	30	
23-1525025	1525025	interior Ø: 21.5mm - exterior Ø: 25mm	15	
23-1525032	1525032	interior Ø: 28.4mm - exterior Ø: 32mm	15	
23-1525040	1525040	interior Ø: 36.1mm - exterior Ø: 40mm	9	



tub flexibil riflat - culoare:gri - "CONFLEX HF" - HALOFEN FREE - de tip greu 1250Nt				
23-2525016	2525016	interior Ø: 10.9mm - exterior Ø: 16mm	50	
23-2525020	2525020	interior Ø: 14mm - exterior Ø: 20mm	50	
23-2525025	2525025	interior Ø: 18.6mm - exterior Ø: 25mm	25	
23-2525032	2525032	interior Ø: 24.3mm - exterior Ø: 32mm	25	
23-2525040	2525040	interior Ø: 31.3mm - exterior Ø: 40mm	20	



doze - culoare:gri - "CONDUR HF" - HALOGEN FREE - IP65				
23-3020416	3020416	67x67x38mm	10	
23-3020420	3020420	82x82x43mm	10	
23-3020425	3020425	101x101x51mm	5	



cot "CONDUR HF" - HALOGEN FREE - culoare:gri				
23-4525016	4525016	cot Ø16	10	
23-4525020	4525020	cot Ø20	10	
23-4525025	4525025	cot Ø25	10	
23-4525032	4525032	cot Ø32	6	
23-4525040	4525040	cot Ø40	6	



mufa "CONDUR" - culoare:gri				
23-4225016	4225016	mufa Ø16	30	
23-4225020	4225020	mufa Ø20	30	
23-4225025	4225025	mufa Ø25	30	
23-4225032	4225032	mufa Ø32	20	
23-4225040	4225040	mufa Ø40	15	



clema "CONDUR" - culoare:gri				
23-4125016	4125016	clema Ø16	50	
23-4125020	4125020	clema Ø20	50	
23-4125025	4125025	clema Ø25	30	
23-4125032	4125032	clema Ø32	30	
23-4125040	4125040	clema Ø40	20	



racord "CONDUR" - culoare:gri				
23-4025016	4025016	racord Ø16	30	
23-4025020	4025020	racord Ø20	30	
23-4025225	4025225	racord Ø25	20	
23-4025232	4025232	racord Ø32	20	





FIBOX - DOZE "PICCOLO" IP66 / IP67 - ABS / PC



FIBOX - DOZE "MNX" IP66 / IP67 - ABS / PC



FIBOX - DOZE "SOLID" IP66 / IP67 - ABS / PC / GRP



FIBOX - DOZE "DG" IP66 / IP67 - ABS / PC



FIBOX - DOZE "EURONORD" IP65/IP66/IP67 - ABS/PC/GRP/AL



FIBOX - DOZE "EK" IP65/IP66/IP67 - PC





FIBOX - DOZE "QUICK" IP66 / IP67 - ABS / PC



FIBOX - DOZE "CARDMASTER" IP65 - ABS / PC



FIBOX - DOZE "ATEX" IP66/IP67 - PC / AL / GRP



FIBOX - TABLOU "CAB" IP65/IP66 - ABS / PC / GRP



Cu Incidenți laterale



FIBOX - TABLOU "MCE" IP65 - ABS / PC



DOZE APARAT SUB TENCUIALA & ACCESORII

MONOKROUSSOS 164

COD DABLEROM	COD PRODUCATOR	DENUMIRE	PAC.	PRET €
doze aparat & accesorii				
39-010	010/02	clasic - 3intrari - Ø6.5cm x l:3.5cm	100	
39-005	4000/03	conectabila- 7intrari - Ø6cm x l:4cm	100	
39-007	4000/01	conectabila- 11intrari - Ø6cm x l:6cm	60	
39-006	4000/02	conector/distantier pt. 39-005 & 39-007	50	
39-020	010/20	prelungitor de 1cm pt.doze aparat	130	
39-021	010/21	prelungitor de 2cm pt.doze aparat	130	



39-010



39-005



39-007



39-006



39-021

39-020

MONOKROUSSOS

DOZE RAMIFICATIE SUB TENCUIALA

COD DABLEROM	COD PRODUCATOR	DENUMIRE	PAC.	PRET €
doze ramificatie rotunde				
39-011	010/01	clasic - 9intrari - Ø7.5cm x l:3.5cm	100	
39-012	010/08	super - 10intrari - Ø10.2cm x l:3.8cm	50	



39-012

doze ramificatie patrate

39-013	010/13	clasic - 10intrari - 7.5x7.5x3.5cm	50	
39-014	010/04	adanca - 8intrari - 7.5x7.5x4.5cm	50	
39-015	010/14	clasic - 14intrari - 10x10x3.5cm	45	
39-016	010/05	adanca - 16intrari - 10x10x5cm	50	

MONOKROUSSOS



39-013



39-014



39-015



39-016

doze ramificatie dreptunghiulare

39-017	010/06	25intrari - 10x15x5cm	25	
39-018	010/07	28intrari - 10x20x5cm	20	
39-019	010/11	32intrari - 15x20x6cm	10	

MONOKROUSSOS



39-017



39-018



39-019

doze ramificatie speciale - *asamblabile*

23-3012003	3012003	13.4x10x4.2cm - doza & capac (complet)	20	
23-3012001	3012001	baza 6.7x10x4.2cm	20	
23-3112001	3112001	capac 11.4x7.3x3.14	20	
23-3012002	3012002	perete despartitor	40	

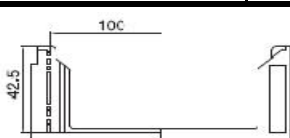
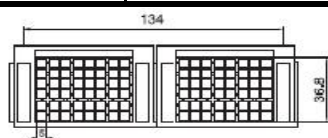
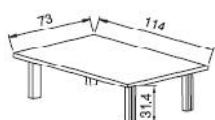

KOUVIDIS

februarie 2012

DOZE PENTRU SPOTURI R50/R63/R80

MONOKROUSSOS 165

COD DABLEROM	COD PRODUCATOR	DENUMIRE	PAC.	PRET €
doze pentru spoturi R50/R63/R80				
39-034	020/02	pentru spot R50 - 4intrari de Ø2cm	20/28	
39-035	020/01	pentru spot R63/R80 - 4intrari de Ø2cm	15/42	



39-034

DOZE SUB TENCUIALA PENTRU RIGIPS

MONOKROUSSOS

COD DABLEROM	COD PRODUCATOR	DENUMIRE	PAC.	PRET €
doze aparat pentru rigips				
39-009	5000/01	clasic - 8intrari - Ø6.8cm x l:4.8cm	50	
39-072	68LA/2	dubla - Ø6.5cm x 2	20	
39-073	68LA/3	tripla - Ø6.5cm x 3	20	
39-074	68LA/4	cvadrupla - Ø6.5cm x 4	10	



39-009



doze ramificatie pentru rigips

39-008	5000/02	clasic - 8intrari - Ø6.8cm x l:4.8cm	60	
39-004	5000/03	super - 12intrari - Ø10.25cm x l:5.1cm	45	
39-077	5000/04	dreptunghiulara - 25intrari - 10x15x5cm	25	
39-078	5000/05	dreptunghiulara - 28intrari - 10x20x5cm	20	

MONOKROUSSOS



39-008



39-004



39-077



CAPACE PENTRU DOZE

MONOKROUSSOS

COD DABLEROM	COD PRODUCATOR	DENUMIRE	PAC.	PRET €
capace cu "urechi"				
39-055	030/01	capac mic cu urechi	250	
39-056	030/07	capac mare cu urechi	150	



capace care protejeaza doza in momentul aplicarii tencuiei

MONOKROUSSOS

39-050	010/0013	pentru doza aparat clasic - Ø6.3cm	200	
39-051	010/0015	pentru doza aparat conectabila - Ø6cm	200	
39-052	010/0014	pentru doza ramificatie clasic - Ø7cm	120	
39-053	010/0016	pentru doza ramificatie super - Ø9.8cm	150	



39-050



39-051



39-052



39-053

februarie 2012

DOZE RAMIFICATIE PE TENCUIA

COD DABLEROM	COD PRODUCATOR	DENUMIRE	PAC.	PRET €
doze ramificatie rotunde pe tencuiala				
39-028	020/11	4intrari - Ø6.5cm x l:3.5cm - IP55	50	
39-029	sbox-026	4intrari - Ø8cm x l:4cm - IP55	50	
39-024	020/07A	B(T) - 3intrari - Ø6.9cm x l:3cm - IP54	50	
39-025	020/07	B(+) - 4intrari - Ø6.9cm x l:3cm - IP54	50	
39-022	020/06	A(T) - 3intrari - Ø7.1cm x l:3cm - IP54	45	
39-023	020/05	A(+) - 4intrari - Ø7.1cm x l:3cm - IP54	45	
39-089	6455	4intrari - Ø10cm x l:4.4cm - IP67	50	



39-028



39-029



39-024



39-025



39-022



39-023



39-089

doze ramificatie "SERIA SOFT" pe tencuiala - ureche de prindere - IP54				
39-026	020/13	6intrari - 6.5x6.5x3.5cm	45	
39-027	020/03	12intrari - 7.5x7.5x3.5cm	45	
39-032	020/14	8intrari - 10x10x4cm	30	
39-080	6410-10	10intrari - 9x4.5x4cm	90	
39-081	6410-20	14intrari - 9x9x4cm	45	
39-082	6410-30	18intrari - 13.5x9x4cm	30	



020/13



020/03



39-032

IP 54
PE
PP lid

IP 54
PE
PP lid

IP 54
PE
PP lid

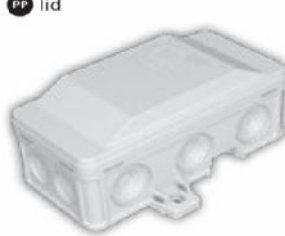

doze - culoare:gri - "CONDUR" - IP65				
23-3020016	3020016	67x67x38mm	10	
23-3020020	3020020	82x82x43mm	10	
23-3020225	3020225	101x101x51mm	5	



doze - culoare:alb - "MEDISOL" - IP65				
23-3034016	3034016	67x67x38mm	10	
23-3034020	3034020	82x82x43mm	10	
23-3034025	3034025	101x101x51mm	5	



doze - culoare:gri - "CONDUR HF" - IP65				
23-3020416	3020416	67x67x38mm	10	
23-3020420	3020420	82x82x43mm	10	
23-3020425	3020425	101x101x51mm	5	



DOZE RAMIFICATIE PE TENCUIALA

COD DABLEROM	COD PRODUCATOR	DENUMIRE	PAC.	PRET €
doze ramificatie "SERIA S-BOX 06" pe tencuiala - cu garnituri - IP54				
39-030	sbox-036B	8x8x4cm	50	
39-031	sbox-106B	10x10x5cm	50	
39-103	sbox-206	12x8x5cm	50	
39-104	sbox-306	15x11x7cm	25	
39-105	sbox-406	19x14x7cm	15	
39-106	sbox-506	24x19x9cm	10	
39-107	sbox-606	30x22x12cm	10	
39-108	sbox-706	38x30x12cm	5	
39-109	sbox-806	46x38x12cm	5	



doze ramificatie "SERIA S-BOX 16" pe tencuiala - IP54				
39-120	sbox-116	10x10x5cm	50	
39-121	sbox-216	12x8x5cm	50	
39-122	sbox-316	15x11x7cm	25	
39-123	sbox-416	19x14x7cm	15	
39-124	sbox-516	24x19x9cm	10	
39-125	sbox-616	30x22x12cm	10	
39-126	sbox-716	38x30x12cm	5	
39-127	sbox-816	46x38x12cm	5	

MONOKROUSSOS



MONOKROUSSOS

doze ramificatie pe tencuiala - speciale - IP54				
39-037	020/19	14intrari - 26x16x8cm - alb mat	7	
39-090	020/16	14intrari - 26x16x13cm - alb mat	4	
39-091	020/15	14intrari - 26x16x13cm - transparent	4	
39-092	020/50	placa de montaj pt. 39-090 & 39-091	4	
39-095	020/18	16intrari - 38x28x15cm - alb mat	3	
39-096	020/17	16intrari - 38x28x15cm - transparent	3	
39-097	020/51	placa de montaj pt. 39-095 & 39-096	3	



39-037



39-090



39-091

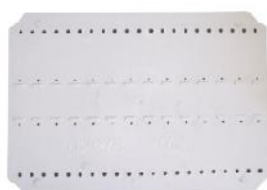

39-092



39-095

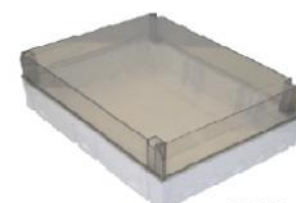

39-096

DOZE PENTRU BETON

MONOKROUSSOS

doze speciale pentru beton				
39-041	6000/01	doza aparat conectabila - IP65	60	
39-040	6000/02	doza ramificatie - IP65	50	
39-042	6000/07	doza ramificatie & iluminat - IP65	15	
39-045	020/04	doza ramificatie 10x10x5cm - IP54	30	
39-060	6000/09	conector de capat pentru copex Ø16mm	20	
39-061	6000/10	conector de capat pentru copex Ø20mm	20	

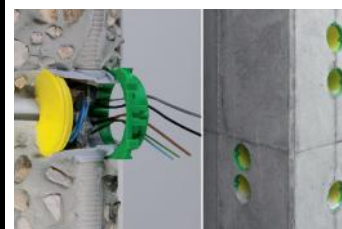

39-041



39-040



39-042



39-045



februarie 2012

TABLOURI METALICE

freder® 168

COD DABLEROM	COD PRODUCATOR	DENUMIRE	PAC.	PRET €
tablouri metalice - cu contrapanou - IP55				
32-400/25	3240025	25x20x15cm	1	
32-400/30	3240030	30x25x15cm	1	
32-400/40	3240040	40x30x20cm	1	
32-400/50	3240050	50x40x20cm	1	
32-400/60	3240060	60x40x20cm	1	
32-400/70	3240070	70x50x20cm	1	
32-400/80	3240080	80x60x25cm	1	
32-400/100	32400100	100x80x30cm	1	
32-400/120	32400120	120x80x30cm	1	



tablouri metalice - cu masca/sina/contrapanou - IP55				
64-030	64030	25x35x13.5cm - 12posturi / 1 sir	1	
64-031	64031	30x40x13.5cm - 22posturi / 2 siruri	1	
64-032	64032	35x45x13.5cm - 39posturi / 3 siruri	1	
64-033	64033	40x50x13.5cm - 45posturi / 3 siruri	1	
64-034	64034	45x65x13.5cm - 72posturi / 4 siruri	1	
64-035	64035	55x75x13.5cm - 114posturi / 5 siruri	1	



tablouri metalice - cu masca/sina/contrapanou - IP65				
32-410	320.12.010	25x35x12cm - 12posturi / 1 sir	1	
32-411	320.12.020	36x35x12cm - 24posturi / 2 siruri	1	
32-412	320.12.030	51x35x12cm - 36posturi / 3 siruri	1	
32-413	320.12.040	51x46x12cm - 45posturi / 3 siruri	1	
32-414	320.12.050	66x46x12cm - 60posturi / 4 siruri	1	
32-415	320.12.060	80x52x12cm - 90posturi / 5 siruri	1	



tablouri metalice - cu usa cu plexiglass/masca/sina/contrapanou - IP55				
64-040	64040	30x40x13.5cm - 22posturi / 2 siruri	1	
64-041	64041	35x45x13.5cm - 39posturi / 3 siruri	1	
64-042	64042	40x50x13.5cm - 45posturi / 3 siruri	1	
64-043	64043	45x65x13.5cm - 72posturi / 4 siruri	1	
64-044	64044	55x75x13.5cm - 114posturi / 5 siruri	1	



TABLOURI DIN PLASTIC

COD DABLEROM	COD PRODUCATOR	DENUMIRE	PAC.	PRET €
tablouri din plastic sub tencuiala - cu usa/sina/bare de nul				
32-310/4	323104	4 module - 1 sir	20	
32-310/6	323106	6 module - 1 sir	20	
32-310/8	323108	8 module - 1 sir	10	
32-310/12	3231012	12 module - 1 sir	10	
32-310/18	3231018	18 module - 1 sir	10	
32-310/24	3231024	24 module - 2 siruri	4	
32-310/36	3231036	36 module - 2 siruri	2	



tablouri din plastic pe tencuiala - cu usa/sina/bare de nul				
32-300/4	323004	4 module - 1 sir	20	
32-300/6	323006	6 module - 1 sir	20	
32-300/8	323008	8 module - 1 sir	10	
32-300/12	3230012	12 module - 1 sir	10	
32-300/18	3230018	18 module - 1 sir	10	
32-300/24	3230024	24 module - 2 siruri	4	
32-300/36	3230036	36 module - 2 siruri	2	



tablouri din plastic pe tencuiala - fara usa - cu sina				
39-200	500/01	2 module - 1 sir	30	
39-201	500/02	4 module - 1 sir	30	



TABLOURI DIN POLIESTER				
tablouri din poliester - cu contrapanou - IP65				
32-450	323.10.010	30x25x16cm	1	
32-451	323.10.020	40x30x18cm	1	
32-452	323.10.030	50x40x19cm	1	
32-453	323.10.040	60x40x21cm	1	
32-454	323.10.050	80x50x28cm	1	



tablouri din poliester - cu masca/sina/contrapanou - IP65				
32-460	323.12.010	20x30x16cm - 12posturi / 1 sir	1	
32-461	323.12.020	25x30x16cm - 24posturi / 2 siruri	1	
32-462	323.12.030	40x30x18cm - 36posturi / 3 siruri	1	
32-463	323.12.040	50x40x19cm - 54posturi / 3 siruri	1	



COD DABLEROM	DENUMIRE	PAC.	PRET €
capac pentru jgheab metalic			
12-010	50 x 15 x 0.75mm	600/3	
12-011	100 x 15 x 0.75mm	360/3	
12-012	150 x 15 x 0.75mm	240/3	
12-013	200 x 15 x 0.75mm	180/3	
12-014	300 x 15 x 0.75mm	120/3	
12-015	400 x 15 x 0.75mm	60/3	
12-016	500 x 15 x 1mm	60/3	
12-017	600 x 15 x 1mm	60/3	

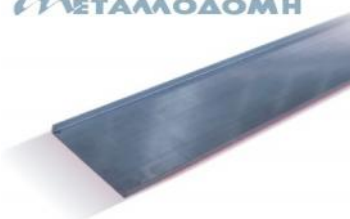

jgheab metalic cu h:35mm			
12-300	50 x 35 x 0.75mm	1020/3	
12-301	100 x 35 x 0.75mm	612/3	
12-302	150 x 35 x 0.75mm	3	
12-303	200 x 35 x 0.75mm	3	
12-304	300 x 35 x 0.75mm	3	
12-305	400 x 35 x 0.75mm	3	
12-306	500 x 35 x 1mm	3	
12-307	600 x 35 x 1mm	3	

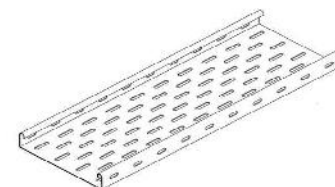

jgheab metalic cu h:60mm			
12-600	50 x 60 x 0.75mm	600/3	
12-601	100 x 60 x 0.75mm	360/3	
12-602	150 x 60 x 0.75mm	240/3	
12-603	200 x 60 x 0.75mm	180/3	
12-604	300 x 60 x 0.75mm	120/3	
12-605	400 x 60 x 1mm	60/3	
12-606	500 x 60 x 1mm	60/3	
12-607	600 x 60 x 1mm	60/3	



jgheab metalic cu h:85mm			
12-801	100 x 85 x 0.75mm	3	
12-802	150 x 85 x 0.75mm	3	
12-803	200 x 85 x 0.75mm	3	
12-804	300 x 85 x 0.75mm	3	
12-805	400 x 85 x 1mm	3	
12-806	500 x 85 x 1mm	3	
12-807	600 x 85 x 1mm	3	

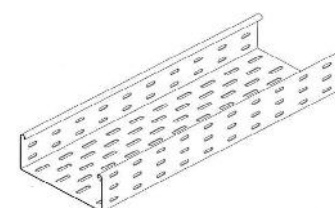

jgheab metalic cu h:110mm			
12-901	100 x 110 x 0.75mm	3	
12-902	150 x 110 x 0.75mm	3	
12-903	200 x 110 x 0.75mm	3	
12-904	300 x 110 x 1mm	3	
12-905	400 x 110 x 1mm	3	
12-906	500 x 110 x 1mm	3	
12-907	600 x 110 x 1mm	3	

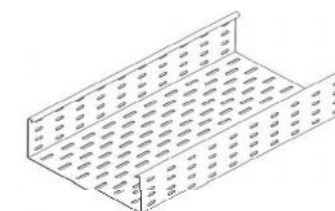

COT 45° PENTRU JGHEABURI METALICE & CAPACE

171



COD DABLEROM	DENUMIRE	PAC.	PRET €
capac cot 45° pentru jgheab metalic			
12-021	100 x 15 x 0.75mm	1	
12-022	150 x 15 x 0.75mm	1	
12-023	200 x 15 x 0.75mm	1	
12-024	300 x 15 x 0.75mm	1	
12-025	400 x 15 x 0.75mm	1	
12-026	500 x 15 x 1mm	1	
12-027	600 x 15 x 1mm	1	



cot 45° pentru jgheab metalic cu h:35mm			
12-321	100 x 35 x 0.75mm	1	
12-322	150 x 35 x 0.75mm	1	
12-323	200 x 35 x 0.75mm	1	
12-324	300 x 35 x 0.75mm	1	
12-325	400 x 35 x 0.75mm	1	
12-326	500 x 35 x 1mm	1	
12-327	600 x 35 x 1mm	1	

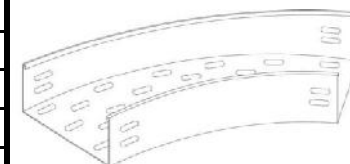

cot 45° pentru jgheab metalic cu h:60mm			
12-621	100 x 60 x 0.75mm	1	
12-622	150 x 60 x 0.75mm	1	
12-623	200 x 60 x 0.75mm	1	
12-624	300 x 60 x 0.75mm	1	
12-625	400 x 60 x 1mm	1	
12-626	500 x 60 x 1mm	1	
12-627	600 x 60 x 1mm	1	

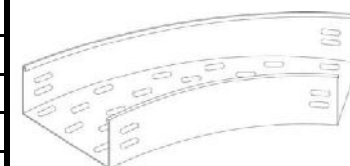

cot 45° pentru jgheab metalic cu h:85mm			
12-821	100 x 85 x 0.75mm	1	
12-822	150 x 85 x 0.75mm	1	
12-823	200 x 85 x 0.75mm	1	
12-824	300 x 85 x 0.75mm	1	
12-825	400 x 85 x 1mm	1	
12-826	500 x 85 x 1mm	1	
12-827	600 x 85 x 1mm	1	

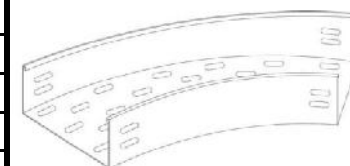

cot 45° pentru jgheab metalic cu h:110mm			
12-921	100 x 110 x 0.75mm	1	
12-922	150 x 110 x 0.75mm	1	
12-923	200 x 110 x 0.75mm	1	
12-924	300 x 110 x 1mm	1	
12-925	400 x 110 x 1mm	1	
12-926	500 x 110 x 1mm	1	
12-927	600 x 110 x 1mm	1	

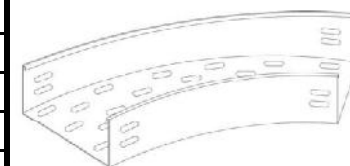

COT 90° PENTRU JGHEABURI METALICE & CAPACE

172



COD DABLEROM	DENUMIRE	PAC.	PRET €
capac cot 90° pentru jgheab metalic			
12-031	100 x 15 x 0.75mm	1	
12-032	150 x 15 x 0.75mm	1	
12-033	200 x 15 x 0.75mm	1	
12-034	300 x 15 x 0.75mm	1	
12-035	400 x 15 x 0.75mm	1	
12-036	500 x 15 x 1mm	1	
12-037	600 x 15 x 1mm	1	



cot 90° pentru jgheab metalic cu h:35mm			
12-331	100 x 35 x 0.75mm	1	
12-332	150 x 35 x 0.75mm	1	
12-333	200 x 35 x 0.75mm	1	
12-334	300 x 35 x 0.75mm	1	
12-335	400 x 35 x 0.75mm	1	
12-336	500 x 35 x 1mm	1	
12-337	600 x 35 x 1mm	1	

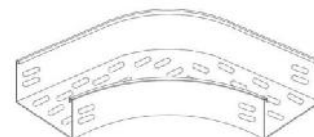

cot 90° pentru jgheab metalic cu h:60mm			
12-631	100 x 60 x 0.75mm	1	
12-632	150 x 60 x 0.75mm	1	
12-633	200 x 60 x 0.75mm	1	
12-634	300 x 60 x 0.75mm	1	
12-635	400 x 60 x 1mm	1	
12-636	500 x 60 x 1mm	1	
12-637	600 x 60 x 1mm	1	



cot 90° pentru jgheab metalic cu h:85mm			
12-831	100 x 85 x 0.75mm	1	
12-832	150 x 85 x 0.75mm	1	
12-833	200 x 85 x 0.75mm	1	
12-834	300 x 85 x 0.75mm	1	
12-835	400 x 85 x 1mm	1	
12-836	500 x 85 x 1mm	1	
12-837	600 x 85 x 1mm	1	

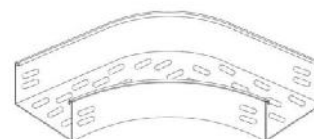

cot 90° pentru jgheab metalic cu h:110mm			
12-931	100 x 110 x 0.75mm	1	
12-932	150 x 110 x 0.75mm	1	
12-933	200 x 110 x 0.75mm	1	
12-934	300 x 110 x 1mm	1	
12-935	400 x 110 x 1mm	1	
12-936	500 x 110 x 1mm	1	
12-937	600 x 110 x 1mm	1	

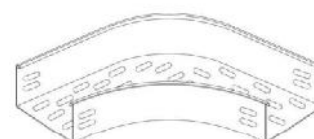

IMBINARE "T" PENTRU JGHEABURI METALICE & CAPACE

173



COD DABLEROM	DENUMIRE	PAC.	PRET €
capac imbinare "T" pentru jgheab metalic			
12-041	100 x 15 x 0.75mm	1	
12-042	150 x 15 x 0.75mm	1	
12-043	200 x 15 x 0.75mm	1	
12-044	300 x 15 x 0.75mm	1	
12-045	400 x 15 x 0.75mm	1	
12-046	500 x 15 x 1mm	1	
12-047	600 x 15 x 1mm	1	

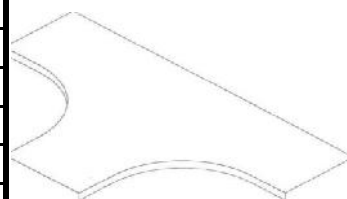

imbinare "T" pentru jgheab metalic cu h:35mm			
12-341	100 x 35 x 0.75mm	1	
12-342	150 x 35 x 0.75mm	1	
12-343	200 x 35 x 0.75mm	1	
12-344	300 x 35 x 0.75mm	1	
12-345	400 x 35 x 0.75mm	1	
12-346	500 x 35 x 1mm	1	
12-347	600 x 35 x 1mm	1	

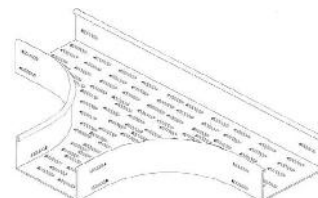

imbinare "T" pentru jgheab metalic cu h:60mm			
12-641	100 x 60 x 0.75mm	1	
12-642	150 x 60 x 0.75mm	1	
12-643	200 x 60 x 0.75mm	1	
12-644	300 x 60 x 0.75mm	1	
12-645	400 x 60 x 1mm	1	
12-646	500 x 60 x 1mm	1	
12-647	600 x 60 x 1mm	1	



imbinare "T" pentru jgheab metalic cu h:85mm			
12-841	100 x 85 x 0.75mm	1	
12-842	150 x 85 x 0.75mm	1	
12-843	200 x 85 x 0.75mm	1	
12-844	300 x 85 x 0.75mm	1	
12-845	400 x 85 x 1mm	1	
12-846	500 x 85 x 1mm	1	
12-847	600 x 85 x 1mm	1	

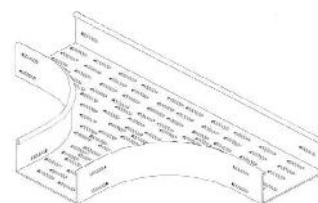

imbinare "T" pentru jgheab metalic cu h:110mm			
12-941	100 x 110 x 0.75mm	1	
12-942	150 x 110 x 0.75mm	1	
12-943	200 x 110 x 0.75mm	1	
12-944	300 x 110 x 1mm	1	
12-945	400 x 110 x 1mm	1	
12-946	500 x 110 x 1mm	1	
12-947	600 x 110 x 1mm	1	

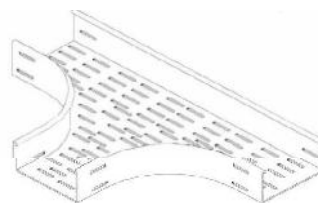

IMBINARE CRUCE "+" PENTRU JGHEABURI METALICE & CAPACE

174

COD DABLEROM	DENUMIRE	PAC.	PRET €
capac imbinare cruce "+" pentru jgheab metalic			
12-051	100 x 15 x 0.75mm	1	
12-052	150 x 15 x 0.75mm	1	
12-053	200 x 15 x 0.75mm	1	
12-054	300 x 15 x 0.75mm	1	
12-055	400 x 15 x 0.75mm	1	
12-056	500 x 15 x 1mm	1	
12-057	600 x 15 x 1mm	1	

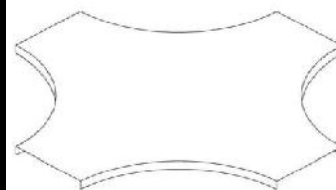

imbinare cruce "+" pentru jgheab metalic cu h:35mm			
12-351	100 x 35 x 0.75mm	1	
12-352	150 x 35 x 0.75mm	1	
12-353	200 x 35 x 0.75mm	1	
12-354	300 x 35 x 0.75mm	1	
12-355	400 x 35 x 0.75mm	1	
12-356	500 x 35 x 1mm	1	
12-357	600 x 35 x 1mm	1	



imbinare cruce "+" pentru jgheab metalic cu h:60mm			
12-651	100 x 60 x 0.75mm	1	
12-652	150 x 60 x 0.75mm	1	
12-653	200 x 60 x 0.75mm	1	
12-654	300 x 60 x 0.75mm	1	
12-655	400 x 60 x 1mm	1	
12-656	500 x 60 x 1mm	1	
12-657	600 x 60 x 1mm	1	

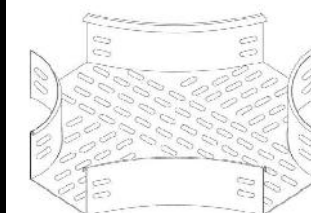

imbinare cruce "+" pentru jgheab metalic cu h:85mm			
12-851	100 x 85 x 0.75mm	1	
12-852	150 x 85 x 0.75mm	1	
12-853	200 x 85 x 0.75mm	1	
12-854	300 x 85 x 0.75mm	1	
12-855	400 x 85 x 1mm	1	
12-856	500 x 85 x 1mm	1	
12-857	600 x 85 x 1mm	1	

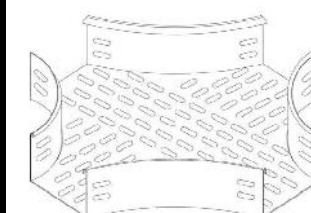

imbinare cruce "+" pentru jgheab metalic cu h:110mm			
12-951	100 x 110 x 0.75mm	1	
12-952	150 x 110 x 0.75mm	1	
12-953	200 x 110 x 0.75mm	1	
12-954	300 x 110 x 1mm	1	
12-955	400 x 110 x 1mm	1	
12-956	500 x 110 x 1mm	1	
12-957	600 x 110 x 1mm	1	

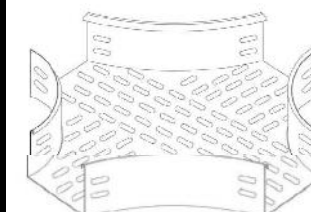

COD DABLEROM	DENUMIRE	PAC.	PRET €
capac cot ridicador/coborator pentru jgheab metalic			
12-061	100 x 15 x 0.75mm	1	
12-062	150 x 15 x 0.75mm	1	
12-063	200 x 15 x 0.75mm	1	
12-064	300 x 15 x 0.75mm	1	
12-065	400 x 15 x 0.75mm	1	
12-066	500 x 15 x 1mm	1	
12-067	600 x 15 x 1mm	1	

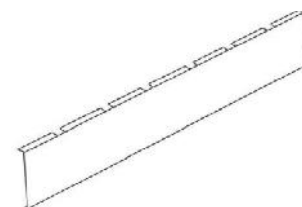

cot ridicador/coborator pentru jgheab metalic cu h:35mm			
12-361	100 x 35 x 0.75mm	1	
12-362	150 x 35 x 0.75mm	1	
12-363	200 x 35 x 0.75mm	1	
12-364	300 x 35 x 0.75mm	1	
12-365	400 x 35 x 0.75mm	1	
12-366	500 x 35 x 1mm	1	
12-367	600 x 35 x 1mm	1	

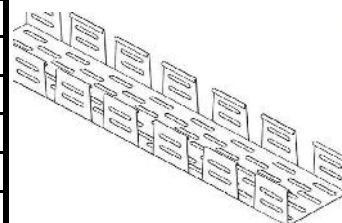

cot ridicador/coborator pentru jgheab metalic cu h:60mm			
12-661	100 x 60 x 0.75mm	1	
12-662	150 x 60 x 0.75mm	1	
12-663	200 x 60 x 0.75mm	1	
12-664	300 x 60 x 0.75mm	1	
12-665	400 x 60 x 1mm	1	
12-666	500 x 60 x 1mm	1	
12-667	600 x 60 x 1mm	1	



cot ridicador/coborator pentru jgheab metalic cu h:85mm			
12-861	100 x 85 x 0.75mm	1	
12-862	150 x 85 x 0.75mm	1	
12-863	200 x 85 x 0.75mm	1	
12-864	300 x 85 x 0.75mm	1	
12-865	400 x 85 x 1mm	1	
12-866	500 x 85 x 1mm	1	
12-867	600 x 85 x 1mm	1	

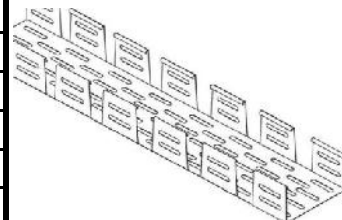

cot ridicador/coborator pentru jgheab metalic cu h:110mm			
12-961	100 x 110 x 0.75mm	1	
12-962	150 x 110 x 0.75mm	1	
12-963	200 x 110 x 0.75mm	1	
12-964	300 x 110 x 1mm	1	
12-965	400 x 110 x 1mm	1	
12-966	500 x 110 x 1mm	1	
12-967	600 x 110 x 1mm	1	

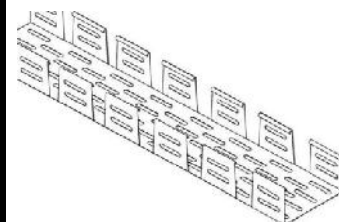

JGHEABURI METALICE TIP SCARA

176

COD DABLEROM	DENUMIRE	PAC.	PRET €
jgheab metalic tip scara cu h:35mm			
13-301	100 x 35 x 1.25mm	3	
13-302	150 x 35 x 1.25mm	3	
13-303	200 x 35 x 1.25mm	3	
13-304	300 x 35 x 1.25mm	3	
13-305	400 x 35 x 1.5mm	3	
13-306	500 x 35 x 1.5mm	3	
13-307	600 x 35 x 1.5mm	3	

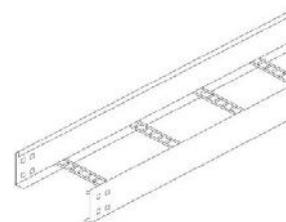

jgheab metalic tip scara cu h:60mm			
13-601	100 x 60 x 1.25mm	3	
13-602	150 x 60 x 1.25mm	3	
13-603	200 x 60 x 1.25mm	3	
13-604	300 x 60 x 1.25mm	3	
13-605	400 x 60 x 1.5mm	3	
13-606	500 x 60 x 1.5mm	3	
13-607	600 x 60 x 1.5mm	3	

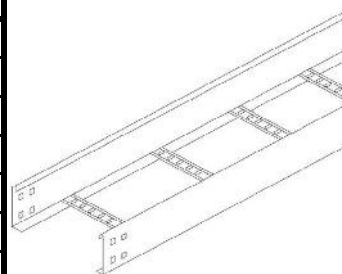

jgheab metalic tip scara cu h:85mm			
13-801	100 x 85 x 1.5mm	3	
13-802	150 x 85 x 1.5mm	3	
13-803	200 x 85 x 1.5mm	3	
13-804	300 x 85 x 1.5mm	3	
13-805	400 x 85 x 1.5mm	3	
13-806	500 x 85 x 1.5mm	3	
13-807	600 x 85 x 1.5mm	3	

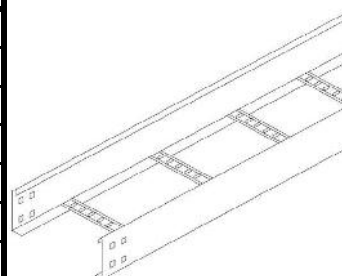

jgheab metalic tip scara cu h:110mm			
13-901	100 x 110 x 1.5mm	3	
13-902	150 x 110 x 1.5mm	3	
13-903	200 x 110 x 1.5mm	3	
13-904	300 x 110 x 1.5mm	3	
13-905	400 x 110 x 1.5mm	3	
13-906	500 x 110 x 1.5mm	3	
13-907	600 x 110 x 1.5mm	3	

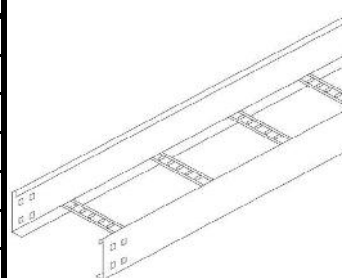

CONECTORI PENTRU JGHEAB SI ACCESORII



177

COD DABLEROM	DENUMIRE	PAC.	PRET €
conector simplu pentru jgheab metalic si accesorii			
12-390	conector simplu pt. jgheab si accesorii cu h:35mm	50	
12-690	conector simplu pt. jgheab si accesorii cu h:60mm	50	
12-890	conector simplu pt. jgheab si accesorii cu h:85mm	50	
12-990	conector simplu pt. jgheab si accesorii cu h:110mm	50	

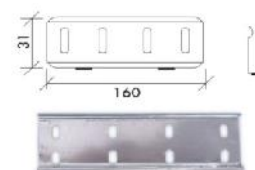

conector flexibil pentru jgheab metalic si accesorii			
12-391	conector flexibil pt. jgheab si accesorii cu h:35mm	50	
12-691	conector flexibil pt. jgheab si accesorii cu h:60mm	50	
12-891	conector flexibil pt. jgheab si accesorii cu h:85mm	50	
12-991	conector flexibil pt. jgheab si accesorii cu h:110mm	50	

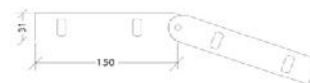

OBLON PENTRU CAPAC JGHEAB

COD DABLEROM	DENUMIRE	PAC.	PRET €
oblon pentru capac - M8			
12-299	oblon pentru capac - M8	100	



SEPARATOR PENTRU JGHEAB

COD DABLEROM	DENUMIRE	PAC.	PRET €
separator pentru jgheab			
12-370	separator cu h:35mm	3	
12-670	separator cu h:60mm	3	
12-870	separator cu h:85mm	3	
12-970	separator cu h:110mm	3	

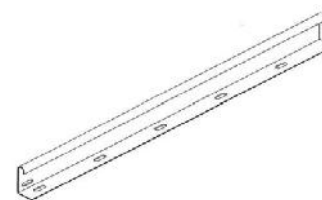

REDUCTIE/CAPAT PENTRU JGHEAB

COD DABLEROM	DENUMIRE	PAC.	PRET €
reductie pentru jgheab			
12-680/R	reductie de 50mm	5	
12-681/R	reductie de 100mm	5	
12-682/R	reductie de 150mm	5	
12-683/R	reductie de 200mm	5	
12-684/R	reductie de 300mm	5	
12-685/R	reductie de 400mm	5	
12-686/R	reductie de 500mm	5	
12-687/R	reductie de 600mm	5	

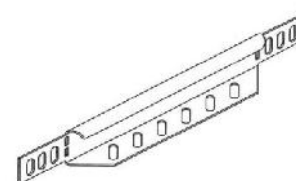

capat pentru jgheab			
12-680/c	capat de 50mm	5	
12-681/c	capat de 100mm	5	
12-682/c	capat de 150mm	5	
12-683/c	capat de 200mm	5	
12-684/c	capat de 300mm	5	
12-685/c	capat de 400mm	5	
12-686/c	capat de 500mm	5	
12-687/c	capat de 600mm	5	

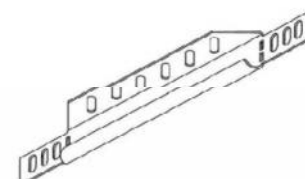

FIXARE "L" & SUPORT SINA

178



COD DABLEROM	DENUMIRE	PAC.	PRET €
fixare "L" tip usor			
12-130	L tip usor - 50x100mm	10	
12-131	L tip usor - 100x150mm	10	
12-132	L tip usor - 150x200mm	10	
12-133	L tip usor - 150x300mm	10	
12-134	L tip usor - 150x400mm	10	

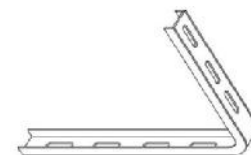

fixare "L" tip greu			
12-140	L tip greu - 100x100mm	10	
12-141	L tip greu - 100x200mm	10	
12-142	L tip greu - 100x300mm	10	
12-143	L tip greu - 100x400mm	10	
12-144	L tip greu - 100x500mm	10	
12-145	L tip greu - 100x600mm	10	



suport sina 30x15x1.5mm			
12-150	suport sina 30x15x1.5mm	3	

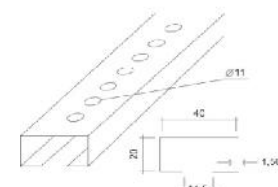

SUPORT SINA 55x35mm & ACCESORII

COD DABLEROM	DENUMIRE	PAC.	PRET €
suport sina 55x35mm & accesorii			
12-151	suport sina 55x35x1.5mm	3	
12-152	suport sina 55x35x2mm	3	
12-153	conector pentru sina 55x35mm	50	
12-156	accesoriu pentru prindere in tavan pentru sina 55x35mm	10	

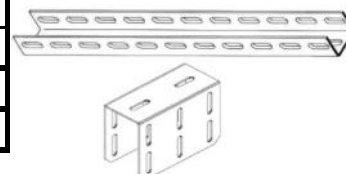

suport consola pentru sina 55x35mm			
12-161	consola 130x1.5mm	10	
12-162	consola 180x1.5mm	10	
12-163	consola 230x1.5mm	10	
12-164	consola 330x1.5mm	10	
12-165	consola 430x1.5mm	10	
12-166	consola 530x1.5mm	10	
12-167	consola 630x1.5mm	10	

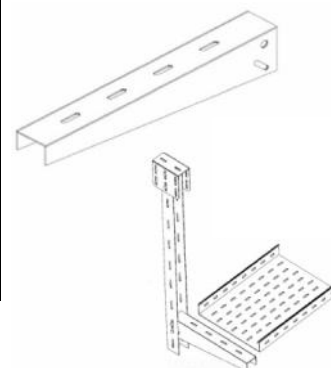

SUPORT CONSOLA PENTRU PERETE

COD DABLEROM	DENUMIRE	PAC.	PRET €
suport consola pentru perete			
12-171	consola perete 105mm	10	
12-172	consola perete 205mm	10	
12-173	consola perete 305mm	10	
12-174	consola perete 405mm	10	
12-175	consola perete 505mm	10	
12-176	consola perete 605mm	10	

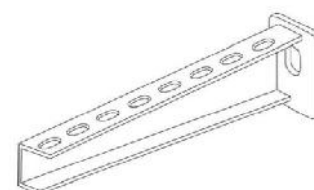

februarie 2012

PROFILE SINA

COD DABLEROM	DENUMIRE	PAC.	PRET €
profile sina			
12-181	profile sina 32x20x1.5mm	3	
12-182	profile sina 32x20x2mm	3	
12-183	profile sina 40x20x1.5mm	3	
12-184	profile sina 40x20x2mm	3	
12-185	profile sina 40x40x1.5mm	3	
12-186	profile sina 40x40x2mm	3	
12-187	profile sina 60x40x2mm	3	

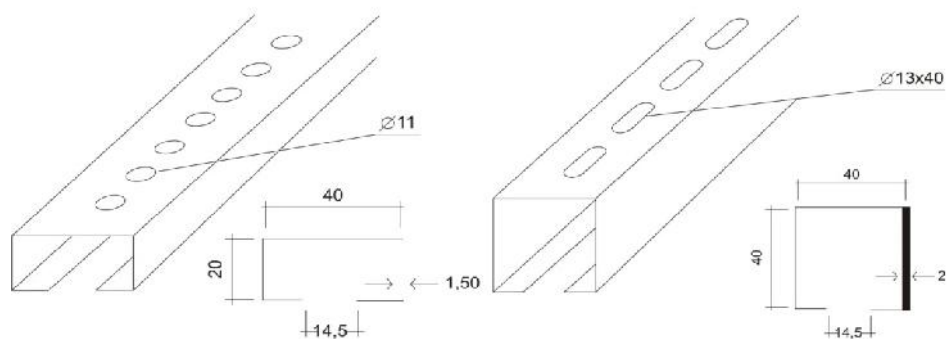
**SUPORT "Ω"**

COD DABLEROM	DENUMIRE	PAC.	PRET €
suport "Ω"			
12-111	50mm	10	
12-112	100mm	10	
12-113	150mm	10	
12-114	200mm	10	

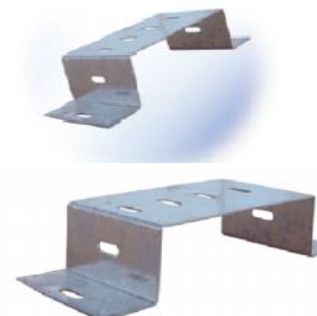
**SUPORT "Γ" PENTRU TAVAN**

COD DABLEROM	DENUMIRE	PAC.	PRET €
suport "Γ" pentru tavan			
12-109	suport "Γ" - 70/40	10	

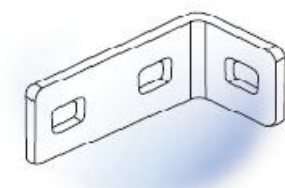

BARE CU FILET & ACCESORII

180



COD DABLEROM	DENUMIRE	PAC.	PRET €
bara cu filet			
12-201	M8mm - 1metru	20	
12-202	M8mm - 2metri	20	
12-203	M10mm - 1metru	20	
12-204	M10mm - 2metri	20	
12-205	M12mm - 1metru	20	
12-206	M12mm - 2metri	20	



mufa pentru bara cu filet			
12-241	M8mm	100	
12-242	M10mm	100	
12-243	M12mm	100	



ancore de coborare			
12-280	M6mm	100	
12-281	M8mm	100	
12-282	M10mm	100	
12-283	M12mm	100	



suport "Π"			
12-120	50mm	10	
12-121	100mm	10	
12-122	150mm	10	
12-123	200mm	10	

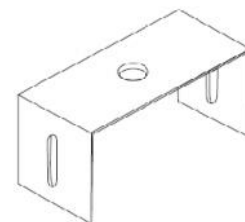

fixator trapez			
12-100	fixator trapez	10	

**SUPPORT BARA**

COD DABLEROM	DENUMIRE	PAC.	PRET €
suport bara cu filet			
12-294	M8mm	20	
12-295	M10mm	20	

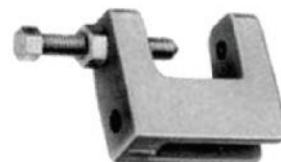

suport bara pentru lant			
12-297	M8mm	20	

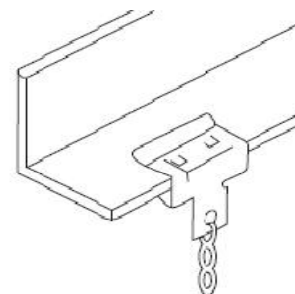

februarie 2012

BOLT CU CAP ROTUND

COD DABLEROM	DENUMIRE	PAC.	PRET €
bolt cu cap rotund (set)			
12-250	M6 x 13 (set)	200	
12-251	M6 x 25 (set)	200	
12-252	M6 x 35 (set)	200	

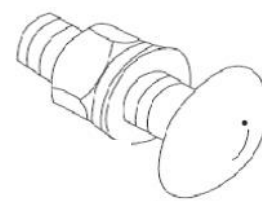
**BOLT HEXAGON**

COD DABLEROM	DENUMIRE	PAC.	PRET €
bolt hexagon (set)			
12-260	M8 x 15 (set)	50	
12-261	M8 x 20 (set)	50	
12-262	M8 x 25 (set)	50	
12-263	M10 x 20 (set)	50	
12-264	M10 x 30 (set)	50	

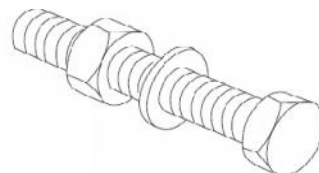
**PANA ANCORARE**

COD DABLEROM	DENUMIRE	PAC.	PRET €
pana ancorare			
12-270	M8 / 85	50	
12-271	M8 / 95	50	
12-272	M10 / 70	50	
12-273	M10 / 90	50	
12-274	M12 / 110	50	

**PIULITE**

COD DABLEROM	DENUMIRE	PAC.	PRET €
piulite normale			
12-210	M6	100	
12-211	M8	100	
12-212	M10	100	
12-213	M12	100	

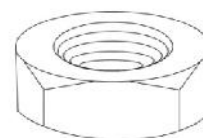
**piulite patrate**

12-215	M8	100	
12-216	M10	100	
12-217	M12	100	

**SAIBE**

COD DABLEROM	DENUMIRE	PAC.	PRET €
saibe normale			
12-230	M8	100	
12-231	M10	100	
12-232	M12	100	
12-233	M8 x 32	100	
12-234	M10 x 40	100	
12-235	M12 x 48	100	



COD DABLEROM	DENUMIRE	PAC.	PRET €
conductor rotund (pret/kg)			
14-180110008	∅8mm - 50mm ² - St/tZn (otel galvanizat)	50	
14-180110010	∅10mm - 78mm ² - St/tZn (otel galvanizat)	50	
14-180120006	∅6mm - 28mm ² - Cu-E (cupru electrolitic)	50	
14-180120008	∅8mm - 50mm ² - Cu-E (cupru electrolitic)	50	
14-180130008	∅8mm - 50mm ² - Al (aliaj de aluminiu)	50	
14-180130009	∅9mm - 64mm ² - Al (aliaj de aluminiu)	50	
14-180190008	∅8mm - 50mm ² - SS (otel inoxidabil)	50	
14-180190010	∅10mm - 78mm ² - SS (otel inoxidabil)	50	



platbanda (pret/kg)			
14-180313335	30x3.5mm - 105mm ² - St/tZn (otel galvanizat)	50	
14-180315330	30x3mm - 90mm ² - St/tZn (otel galvanizat)	50	
14-180310404	40x4mm - 160mm ² - St/tZn (otel galvanizat)	50	
14-180320302	30x2mm - 60mm ² - Cu-E (cupru electrolitic)	50	
14-180320303	30x3mm - 90mm ² - Cu-E (cupru electrolitic)	50	
14-180320403	40x3mm - 120mm ² - Cu-E (cupru electrolitic)	50	
14-180380302	30x2mm - 60mm ² - Cu-E/Sn (cupru electrolitic/galvanizat)	50	
14-180380303	30x3mm - 90mm ² - Cu-E/Sn (cupru electrolitic/galvanizat)	50	
14-180380403	40x3mm - 120mm ² - Cu-E/Sn (cupru electrolitic/galvanizat)	50	



banda de prelungire si conectare (banda de cupru flexibila cu capete rigide)			
14-180581516	16mm ² - L: 150mm - Cu-E (cupru electrolitic)	1	
14-180582516	16mm ² - L: 250mm - Cu-E (cupru electrolitic)	1	
14-180582525	25mm ² - L: 250mm - Cu-E (cupru electrolitic)	1	



tija FLANKLIN & adaptor			
14-180693010	tija ∅30mm x 1000mm - SS (otel inoxidabil)	1	
14-183180114	adaptor tija ∅30mm - Ms/eNi (aliaj de cupru nichelat)	1	



punct de captare 5 elemente & adaptor			
14-180675016	punct captare cu 5tije FLANKLIN(pt. conductor max.∅16mm)	1	
14-180670016	adaptor pentru prinderea punctului de captare	1	



punct de captare			
14-180611020	∅10mm x 200mm - St/tZn (otel galvanizat)	1	
14-180621020	∅10mm x 200mm - Cu-E (cupru electrolitic)	1	



punct de captare cu baza			
14-180691630	punct de captare ∅16x300mm-Ms/eNi(aliaj cupru nichelat)	1	
14-180691660	punct de captare ∅16x600mm-Ms/eNi(aliaj cupru nichelat)	1	
14-180610010	baza tije ∅10mm - St/tZn (otel galvanizat)	1	



SISTEME PARATRASNET

183

COD DABLEROM	DENUMIRE	PAC.	PRET €
punct de captare cu stalp			
14-180111630	punct de captare Ø16x380mm-Ms/eNi(aliaj cupru nickelat)	1	
14-180111660	punct de captare Ø16x680mm-Ms/eNi(aliaj cupru nickelat)	1	



tija de protectie (cu prindere cu 2 perforatii de Ø11)			
14-180012150	prindere la un capat - Ø16x1500mm - St/tZn (galvanizat)	1	
14-180011200	prindere la un capat - Ø16x2000mm - St/tZn (galvanizat)	1	
14-180021200	prindere la un capat - Ø16x2000mm - Cu (cupru)	1	
14-180012200	prindere la doua capete - Ø16x2000mm -St/tZn (galvanizat)	1	
14-180022200	prindere la doua capete - Ø16x2000mm - Cu (cupru)	1	



suport tija			
14-186110016	Ø16mm - St/tZn (otel galvanizat)	1	
14-186120016	Ø16mm - Cu (cupru)	1	



suport conductor pentru tigla de coama			
14-186119200	Ø8x10mm - SS-St/tZn (otel galvanizat cu baza din otel)	1	
14-186129200	Ø8x10mm - SS-Cu (cupru cu baza din otel)	1	



suport conductor pentru acoperis de tigla si tabla ondulata			
14-186115422	Ø8x10mm - St/tZn (otel galvanizat)	1	
14-186125422	Ø8x10mm - Cu (cupru)	1	



suport conductor tip "CLIP" cu soclu			
14-186191008	Ø8mm - SS (otel inoxidabil)	1	
14-186191010	Ø10mm - SS (otel inoxidabil)	1	



suport conductor cu soclu			
14-186113810	Ø8-10mm - SS-St/tZn (otel galvanizat cu baza din otel)	1	
14-186123810	Ø8-10mm - SS-Cu (cupru cu baza din otel)	1	



suport conductor pentru acoperis tip terasa			
14-186150810	Ø8-10mm - PVC (gol)	1	
14-186151810	Ø8-10mm - PVC (umplut cu ciment)	1	



suport conductor pentru perete			
14-484111810	Ø8-10mm - St/tZn (otel galvanizat)	1	
14-486121810	Ø8-10mm - Cu (cupru)	1	



SISTEME PARATRASNET

184

COD DABLEROM	DENUMIRE	PAC.	PRET €
suport conductor tip "CLIP" pentru perete			
14-186192008	Ø8mm - SS (otel inoxidabil)	1	
14-186192010	Ø10mm - SS (otel inoxidabil)	1	



saiba de izolare			
14-186050810	Ø30mm - PVC	1	



suport conductor universal tip "CLIP"			
14-186190008	Ø8mm - SS (otel inoxidabil)	1	
14-186190010	Ø10mm - SS (otel inoxidabil)	1	



suport conductor cu filet intern			
14-186110206	Ø8-10mm - M6 - L: 20mm - St/tZn (otel galvanizat)	1	
14-186110208	Ø8-10mm - M8 - L: 20mm - St/tZn (otel galvanizat)	1	
14-186110508	Ø8-10mm - M8 - L: 50mm - St/tZn (otel galvanizat)	1	
14-186111008	Ø8-10mm - M8 - L: 100mm - St/tZn (otel galvanizat)	1	
14-186120206	Ø8-10mm - M6 - L: 20mm - Cu (cupru)	1	
14-186120208	Ø8-10mm - M8 - L: 20mm - Cu (cupru)	1	
14-186120508	Ø8-10mm - M8 - L: 50mm - Cu (cupru)	1	
14-186121008	Ø8-10mm - M8 - L: 100mm - Cu (cupru)	1	



clema fixare din alama			
14-186170835	pentru conductor 25-35mm ² - M8 - Ms/Cu (aliaj de cupru)	1	
14-186178350	pentru conductor 35-50mm ² - M8 - Ms/Cu (aliaj de cupru)	1	



suport platbanda			
14-186212505	max.50x5mm - St/tZn (galvanizat)	1	
14-186222505	max.50x5mm - Cu (cupru)	1	
14-186292505	max.50x5mm - SS (otel inoxidabil)	1	



suport platbanda cu filet intern			
14-186210206	max.30x3.5mm - M6 - L: 20mm - St/tZn (otel galvanizat)	1	
14-186210208	max.30x3.5mm - M8 - L: 20mm - St/tZn (otel galvanizat)	1	
14-186210508	max.30x3.5mm - M8 - L: 50mm - St/tZn (otel galvanizat)	1	
14-186211008	max.30x3.5mm - M8 - L: 100mm - St/tZn (otel galvanizat)	1	
14-186220206	max.30x3.5mm - M6 - L: 20mm - Cu (cupru)	1	
14-186220208	max.30x3.5mm - M8 - L: 20mm - Cu (cupru)	1	
14-186220508	max.30x3.5mm - M8 - L: 50mm - Cu (cupru)	1	
14-186221008	max.30x3.5mm - M8 - L: 100mm - Cu (cupru)	1	



SISTEME PARATRASNET

185

COD DABLEROM	DENUMIRE	PAC.	PRET €
clema de legatura			
14-184140008	Ø8mm - Zn (zincat)	1	
14-184140010	Ø10mm - Zn (zincat)	1	



clema de legatura simpla			
14-184111181	Ø8-10mm - St/tZn (galvanizat)	1	
14-184121281	Ø8-10mm - Cu (cupru)	1	
14-184131181	Ø8-10mm - Al (aliaj de aluminiu)	1	



clema de legatura dubla			
14-184112181	Ø8-10mm - St/tZn (galvanizat)	1	
14-184122281	Ø8-10mm - Cu (cupru)	1	
14-184132181	Ø8-10mm - Al (aliaj de aluminiu)	1	
14-184162681	Ø8-10mm - Zn+Al+Cu (aliaj de aluminiu,galvanizat)	1	

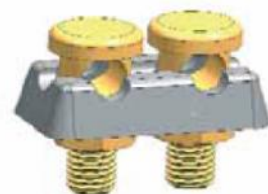

clema de trecere cruce pentru conductor rotund			
14-484113488b	conductor Ø8-12mm / Ø8-12mm - St/tZn (otel galvanizat)	1	
14-184122816	conductor Ø8-12mm / Ø16mm - St/tZn (otel galvanizat)	1	
14-184113826	conductor Ø16mm / Ø16mm - St/tZn (otel galvanizat)	1	
14-484183488	conductor Ø8-12mm / Ø8-12mm -Cu/eSn(cupru galvanizat)	1	
14-184182816	conductor Ø8-12mm / Ø16mm - Cu/eSn(cupru galvanizat)	1	
14-184183826	conductor Ø16mm / Ø16mm - Cu/eSn(cupru galvanizat)	1	



clema de trecere cruce pentru platbanda			
14-484313433b	platbanda 30mm / 30mm - St/tZn (otel galvanizat)	1	
14-484313444b	platbanda 40mm / 40mm - St/tZn (otel galvanizat)	1	
14-484323430	platbanda 30mm / 30mm - Cu (cupru)	1	
14-484323444	platbanda 40mm / 40mm - Cu (cupru)	1	
14-484383430	platbanda 30mm / 30mm - Cu (cupru)	1	
14-484383444	platbanda 40mm / 40mm - Cu/eSn(cupru galvanizat)	1	

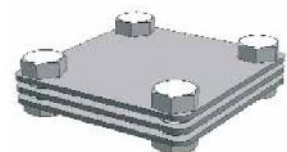

piesa de separatie			
14-184812181	Ø8-10mm / Ø8-10mm - St/tZn (otel galvanizat)	1	
14-184822681	Ø8-10mm / Ø8-10mm - Cu (cupru)	1	
14-184882881	Ø8-10mm / Ø8-10mm - Cu (cupru)	1	
14-184802081	Ø8-10mm / Ø8-10mm - St/tZn-SS-Cu (bimetal)	1	

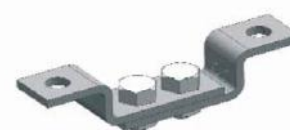

clema tip "VARIO"			
14-184110810	Ø8-10mm - St/tZn (otel galvanizat)	1	
14-184120810	Ø8-10mm - Cu (cupru)	1	
14-184190810	Ø8-10mm - SS (otel inoxidabil)	1	



SISTEME PARATRASNET

186

COD DABLEROM	DENUMIRE	PAC.	PRET €
clema pentru tarusi rotunzi			
14-182461016	Ø16mm - Zg/eCu (galvanizat zincat)	1	
14-182471168	Ø16-18mm - Ms (aliaj de cupru)	1	
14-182401168	Ø16-18mm - Zg/eCu (galvanizat zincat)	1	



mufe imbinare pentru tarusi rotunzi			
14-182570014	Ø14mm - Ms (aliaj de cupru)	1	
14-182570016	Ø16mm - Ms (aliaj de cupru)	1	
14-182570017	Ø17mm - Ms (aliaj de cupru)	1	



tarusi rotunzi			
14-182161415t	Ø14x1500mm - St/eCu (cupru galvanizat la 25µm)	1	
14-182161715t	Ø17x1500mm - St/eCu (cupru galvanizat la 25µm)	1	
14-182161730s	Ø17x3000mm - St/eCu (cupru galvanizat la 25µm)	1	
14-182161615	Ø16x1500mm - St/eCu (cupru galvanizat la 5µm)	1	



tarusi cruce			
14-182213515	50x50x3mm - L:1500mm - St/tZn (otel galvanizat)	1	
14-182213520	50x50x3mm - L:2000mm - St/tZn (otel galvanizat)	1	
14-182213525	50x50x3mm - L:2500mm - St/tZn (otel galvanizat)	1	
14-182213530	50x50x3mm - L:3000mm - St/tZn (otel galvanizat)	1	



tarusi mini			
14-182010250	Ø10mm sau 40x4mm - L:250mm - St/tZn (otel galvanizat)	1	
14-182010400	Ø10mm sau 40x4mm - L:400mm - St/tZn (otel galvanizat)	1	



sina protectie echipotentiala			
14-182903025	7 terminale pentru conductor 6-25mm ² - bara de alama	1	



sina protectie echipotentiala			
14-182903026	6 terminale pentru conductor 6-25mm ² - bara de cupru	1	



sina protectie echipotentiala			
14-482926233	230x40x3mm - Cu (cupru)	1	
14-482929313	310x40x3mm - Cu (cupru)	1	
14-482921138	380x40x3mm - Cu (cupru)	1	
14-482921444	440x40x3mm - Cu (cupru)	1	



holtsurub cu filet pe capat			
14-186505706	M6 - St/eSn (otel galvanizat)	50	
14-186505708	M8 - St/eSn (otel galvanizat)	50	



clema legatura si capat			
14-184711181	Ø8-10mm sau 30x3.5mm - St/tZn (otel galvanizat)	1	



STABILIZATOARE

187

COD DABLEROM	COD PRODUCATOR	DENUMIRE	PAC.	PRET €
stabilizatoare monofazice cu servomotor				
61-002	26-501	500VA / 353W - cu siguranta de 2A L:185mm W:170mm h:125mm	4	
61-003	26-1001	1.000VA / 700W - cu siguranta de 4A L:210mm W:200mm h:155mm	2	
61-004	26-01501	1.500VA / 1.060W - cu siguranta de 6A L:210mm W:200mm h:155mm	2	
61-005	26-2001	2.000VA / 1.414W - cu siguranta de 10A L:245mm W:275mm h:185mm	1	
61-006	26-3001	3.000VA / 2.121W - cu siguranta de 16A L:235mm W:260mm h:225mm	1	
61-007	26-5001	5.000VA / 3.535W - cu siguranta de 20A L:235mm W:315mm h:270mm	1	
61-009	26-10001	10.000VA/7.070W - cu siguranta de 40A L:430mm W:260mm h:390mm	1	



stabilizatoare trifazice cu servomotor				
61-030	26-9003	9.000VA / 6.300W - cu siguranta de 16A L:355mm W:350mm h:760mm	1	
61-031	26-15003	15.000VA/10.500W-cu siguranta de 25A L:370mm W:360mm h:860mm	1	
61-032	26-20003	20.000VA/14.000W-cu siguranta de 32A L:430mm W:405mm h:830mm	1	
61-935	26-30003	30.000VA/24.000W-cu siguranta de 50A L:515mm W:430mm h:925mm	1	
61-936	018.12.070	40.000VA / 32.000W	1	
61-937	018.12.080	50.000VA / 40.000W	1	
61-938	018.12.090	60.000VA / 48.000W	1	
61-939	018.12.100	75.000VA / 60.000W	1	
61-940	018.12.110	90.000VA / 72.000W	1	
61-941	018.12.***	100.000VA - 500.000VA	1	



UPSURI MONOFAZICE

COD DABLEROM	COD PRODUCATOR	DENUMIRE	PAC.	PRET €
UPS monofazic (italia)				
61-050	010.10.010	240W - autonomia 6min.	1	
61-051	010.10.020	360W - autonomia 6min.	1	
61-052	010.10.030	480W - autonomia 6min.	1	
61-053	010.10.040	600W - autonomia 6min.	1	
61-054	010.10.050	900W - autonomia 6min.	1	
61-055	010.10.060	1200W - autonomia 6min.	1	



INVERTOARE DE TENSIUNE

COD DABLEROM	COD PRODUCATOR	DENUMIRE	PAC.	PRET €
invertoare de la 12V DC la 230V AC				
61-100	028.10.010	150W - 162x104x58mm	1	
61-101	028.10.020	300W - 232x104x58mm	1	
61-102	028.10.040	500W - 220x180x68mm	1	
61-103	028.10.050	600W - 290x205x73mm	1	
61-104	028.10.060	800W - 330x240x77mm	1	
61-105	028.10.070	1000W - 430x242x80mm	1	
61-106	028.10.080	1500W - 430x240x77mm	1	
61-107	028.10.090	2000W - 330x190x70mm	1	



invertoare de la 24V DC la 230V AC				
61-110	028.15.010	150W - 162x104x58mm	1	
61-111	028.15.020	300W - 232x104x58mm	1	
61-112	028.15.040	500W - 220x180x68mm	1	
61-113	028.15.050	600W - 290x205x73mm	1	
61-114	028.15.060	800W - 330x240x77mm	1	
61-115	028.15.070	1000W - 430x242x80mm	1	
61-116	028.15.080	1500W - 430x240x77mm	1	
61-117	028.15.090	2000W - 330x190x70mm	1	

**VARIATOARE**

COD DABLEROM	COD PRODUCATOR	DENUMIRE	PAC.	PRET €
variatoare monofazice - 0-250V				
61-080	024.10.010	500 VA	1	
61-081	024.10.020	1.000 VA	1	
61-082	024.10.030	2.000 VA	1	
61-083	024.10.040	3.000 VA	1	
61-084	024.10.050	5.000 VA	1	
61-085	024.10.060	10.000 VA	1	



variatoare trifazice - 0-400V				
61-090	024.12.010	500 VA	1	
61-091	024.12.020	1.000 VA	1	
61-092	024.12.030	2.000 VA	1	
61-093	024.12.040	3.000 VA	1	
61-094	024.12.050	5.000 VA	1	
61-095	024.12.070	10.000 VA	1	



SPRAY-URI

COD DABLEROM	COD PRODUCATOR	DENUMIRE	PAC.	PRET €
spray antirugina 300ml				
03-029/15	1-000015	curata de rugina / efect de gresare protejeaza de gresare	7	
spray lubrifiant 300ml				
03-029/16	1-000016	efect puternic de lubrifiere (ungere) impermeabilitate - temp. maxima 150°C	7	
spray pentru contacte fara ulei 450ml				
03-029/17	1-000017	elimina urme de ulei si impuritati fara efecte secundare pentru izolatii	6	
spray pentru contacte cu ulei 450ml				
03-029/18	1-000018	efect de curatare a sarurilor protejeaza impotriva oxidarii imbunatatirea contactul./conductivitatii elimina efectul de flama (scanteie)	6	
spray pentru galvanizare (ZINC) 450ml				
03-029/25	1-000025	contine zinc pur protectie impotriva oxidarii si ruginirii	6	
spray siliconic 450ml				
03-029/32	1-000032	efect de gresare protectie la umiditate & coroziune	6	

**CUTII/SERTARE DEPOZITARE**

COD DABLEROM	COD PRODUCATOR	DENUMIRE	PAC.	PRET €
cutii - cutiile de aceasi dimensiune se pot suprapune				
39-300	100/05	mini - L:14.5 x l:8.7 x i:6.6 cm	36	
39-301	100/03	mic - L:23 x l:17 x i:12 cm	36	
39-302	100/04	medium - L:35 x l:20 x i:20 cm	10	
39-303	100/01	mare(cu bara) - L:41 x l:29.5 x i:22.5 cm	5	
sertare - se poate imbina orizontala sau verticala - se pot compartimenta in 1.2 sau 4 parti egale				
39-310	100/06	mic - L:12.2 x l:15 x i:8.4 cm	6	
39-311	100/02	mare - L:29 x l:25 x i:12 cm	6	

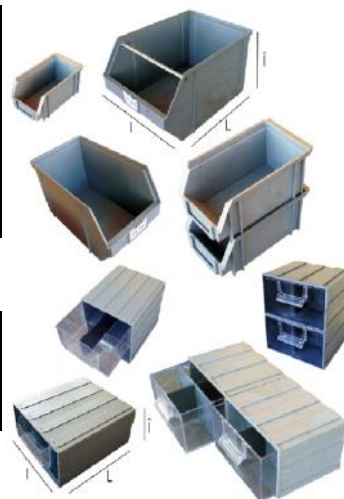
**CUREA / GEANTA PENTRU SCULE**

COD DABLEROM	COD PRODUCATOR	DENUMIRE	PAC.	PRET €
curea din piele pentru scule				
03-132	15-8186	curea din piele	1	
geanta din piele pentru scule				
03-133	15-8180	geanta din piele - 45x26x18cm	1	



TESTER & APARATE DE MASURA

190

COD DABLEROM	COD PRODUCATOR	DENUMIRE	PAC.	PRET €
--------------	----------------	----------	------	--------

surubelnita tester digitala - 12V pana la 220V AC/DC

03-000	15-70	surubelnita tester 12V-220V AC/DC 124x13x16mm - ecran:LCD	20	
--------	-------	--	----	--



surubelnita multitester

03-001	15-81	surubelnita multitester transparent - (blister)	6	
--------	-------	--	---	--



tester cu buzzer si led

03-002	15-83	tester cu buzzer si led prezenta tensiune - 70V pana 220V AC	6	
--------	-------	---	---	--



tester cu cablu si led

03-003	15-80	tester cu cablu si led (blister) 12V pana 400V AC & 12V pana 500V DC	5	
--------	-------	---	---	--



volt tester - 120V pana 240V

03-004	10-8900	volt tester -120V pana 240V (blister) distanța detectie < 5mm	20/1	
--------	---------	--	------	--



network multitester (UTP/FTP/TV)

03-340	10-6810	testarea retelelor(UTP,FTP,STP,TV,BNC) verifica scurt circuitul,fire intrerupte etc.	1	
--------	---------	---	---	--



detector cabluri (detecteaza continuitatea liniilor electrice & telefonice)

03-341	10-6812	2 componente (emitorator & receptor) detecteaza continuitatea liniilor	1	
--------	---------	---	---	--



indicator sens rotatie

03-336	10-5900	determina sensul de rotatie la motor directia campului rotativ conexiune motor - sistem 3 faze	1	
--------	---------	--	---	--

luxmetru

03-332	10-6610	de la 0 lux pana la 50.000lux 125.5x72x27mm	1	
--------	---------	--	---	--



termometru cu infrarosu

03-335	10-6530	de la -20°C pana la +520°C LCD display - timp de raspuns: 0.5sec,	1	
--------	---------	--	---	--



teluometru

03-334	10-5209	rezistenta impamantare:10/100/1000Ω tensiune impamantare 30V AC (5KΩ/V)	1	
--------	---------	--	---	--



ohm-metru digital (MEGER)

03-333	10-5201	250V,500V,1000V pana la 2000MΩ DC 1000V - AC 700V - buzzer	1	
--------	---------	---	---	--



februarie 2012

APARATE DE MASURA / MULTIMETRE

191

COD DABLEROM	COD PRODUCATOR	DENUMIRE	PAC.	PRET €
--------------	----------------	----------	------	--------

multimetru analogic

03-304	10-7040	DC 1000V - AC 1000V - DC 10A	1	
		ΩHM - buzzer - dioda		



multimetru digital de buzunar

03-310	10-831	DC 500V - AC 500V - DC 0.2A	100/1	
		ΩHM - buzzer - dioda		



multimetru digital simplu cu carcasa de cauciuc

03-311	10-832	DC 600V - AC 600V - DC 10A	40/1	
		ΩHM - hFE - dioda		



multimetru digital si carcasa de cauciuc

03-312	10-838	DC 600V - AC 600V - DC 10A - ΩHM	40/1	
		buzzer- hFE - dioda		



multimetru digital profesional cu carcasa de cauciuc

03-313	10-833	DC 600V-AC 600V-DC10A -AC10A -ΩHM	20/1	
		buzzer-hFE -dioda -HZ- °C (-20...+1000°C)		

multimetru digital profesional multifunctional

03-314	10-8209	AC/DC 600V - AC/DC 10A - ΩHM - buzzer	20/1	
		hFE - dioda - HZ - °C (-20...+1000°C)		
		RH(humiditate) - dB(34-100) - LUX		



APARATE DE MASURA / CLAMPMETRE

COD DABLEROM	COD PRODUCATOR	DENUMIRE	PAC.	PRET €
--------------	----------------	----------	------	--------

clampmetru digital mini

03-321	10-2002	DC 600V - AC 600V - AC 200A	40/1	
		ΩHM - buzzer		



clampmetru digital cu husa

03-322	10-0266	DC 1000V - AC 750V - AC 1000A	20/1	
		ΩHM - buzzer		



clampmetru digital cu servieta

03-324	10-9912	DC 1000V- DC 1000A- AC 750V -AC 1000A	10/1	
		ΩHM - buzzer - dioda - HZ		



februarie 2012

SCULE

192

COD DABLEROM	COD PRODUCATOR	DENUMIRE	PAC.	PRET €
surubelnite drepte - 1000V				
33-260	15-65111	3 x 75mm	240/6	
33-261	15-65121	4 x 100mm	240/6	
33-262	15-65131	5.5 x 125mm	192/6	
33-263	15-65141	6.5 x 150mm	144/6	



surubelnite cruce - 1000V				
33-264	15-65211	No 0 - 3 x 75mm	240/6	
33-265	15-65221	No 1 - 4.5 x 80mm	240/6	
33-266	15-65231	No 2 - 6 x 100mm	192/6	
33-267	15-65241	No 3 - 8 x 150mm	96/6	



set 8 surubelnite (4drepte+4cruce) - 1000V				
33-2600	15-65	set 8 surubelnite	20/1	



patent pensa				
33-201	915-003	patent pensa L: 180mm	60/6	
33-202	915-004	patent pensa L: 200mm	60/6	



cleste cu cioc				
33-220	390.12.010	cleste cu cioc L: 180mm - drept	60/6	
33-221	390.12.020	cleste cu cioc L: 180mm - inclinat 45°	60/6	



cleste de taiat				
33-210	915-006	cleste de taiat L: 160mm	120/6	
33-211	915-007	cleste de taiat L: 180mm	60/6	



cleste dezizolat cablu - metal-plastic				
03-080	915-700	pentru cablu 0.2 - 6mm ²	50/10	



cleste dezizolat cablu - plastic				
03-081	915-702	pentru cablu 0.2 - 4mm ²	8/1	



dezizolator/cuter cablu - metal-plastic				
03-082	915-721	de la Ø:8mm pana la Ø:28mm	48/12	



freza universala (pentru rigips,plastic,lemn)				
03-120	915-800	minim 30mm - maxim 260mm	4/1	



SCULE

193

COD DABLEROM	COD PRODUCATOR	DENUMIRE	PAC.	PRET €
foarfeca-dezizolator				
33-233	915-1165	pana la \varnothing :170mm - L:165mm	80/10	



cleste de taiat cablu				
33-230	915-165	pentru cablu pana la \varnothing :30mm- L:165mm	80/10	



cleste de taiat cablu				
03-091	915-3241	pentru cablu pana la \varnothing :40mm- L:540mm	10/1	
03-092	915-3242	pentru cablu pana la \varnothing :50mm- L:690mm	2/1	



cleste de taiat cablu cu clichet				
03-093	915-3401	pentru cablu pana la \varnothing :22mm- L:260mm	10/1	



cleste de taiat cablu cu clichet				
03-094	393.12.070	pentru cablu pana la \varnothing :22mm/150mm ²	2/1	



cleste de taiat cablu cu clichet				
03-095	393.12.060	pentru cablu pana la \varnothing :52mm/400mm ²	2/1	



cuter pentru tubulatura de plastic				
03-096	915-015	pentru tub pana la \varnothing :35mm	50/10	
03-097	915-016	pentru tub pana la \varnothing :42mm	50/10	



pistol de lipit pentru cositor				
03-034	400.24.010	100W - 230V	2/1	



ciocan de lipit pentru cositor				
03-031/60	400.14.030	100W - 230V	2/1	
03-031/80	400.14.040	100W - 230V	2/1	
03-031/100	400.14.050	100W - 230V	2/1	



cositor				
03-036/20	400.18.040	20 gr	2/1	
03-036/100	400.18.030	100 gr	2/1	
03-036/250	400.18.020	250 gr	2/1	
03-036/500	400.18.010	500 gr	2/1	



pasta decapanta				
03-040	400.20.010	50 gr	2/1	



pistol siliconic / silicon				
03-020	400.10.010	pistol 30W - 230V	2/1	
03-021	400.10.020	pistol 65W - 230V	2/1	
03-024	400.12.010	silicon 100mm- \varnothing :11.1mm (pret set 12 b.)	1	
03-025	400.12.020	silicon 300mm- \varnothing :11.1mm	1	



PRESE PENTRU PAPUCI NEIZOLATI

194

COD DABLEROM	COD PRODUCATOR	DENUMIRE	PAC.	PRET €
--------------	----------------	----------	------	--------

presa cu clichet

03-071	915-7	pentru papuci neizolati 1.5...6mm ²	40/10	
--------	-------	--	-------	--



presa cu clichet

03-072	915-10	pentru papuci neizolati 1.5...10mm ²	20/10	
--------	--------	---	-------	--



presa cu clichet

03-073/1	393.10.060	pentru papuci neizolati 2.5...16mm ²	2/1	
----------	------------	---	-----	--



presa cu clichet

03-073/2	915-16	pentru papuci neizolati 6...25mm ²	20/10	
----------	--------	---	-------	--



presa mecanica hexagonala

03-098	915-1650	pentru papuci neizolati 6...50mm ²	8/1	
03-099	915-116120	pentru papuci neizolati 16...120mm ²	4/1	



presa hidraulica hexagonala

03-076	393.14.030	pentru papuci neizolati 4...70mm ²	2/1	
--------	------------	---	-----	--



presa hidraulica hexagonala

03-077	915-300	pentru papuci neizolati 16...300mm ²	4/1	
--------	---------	---	-----	--



presa hidraulica hexagonala (2 module)

03-079	915-3001	pentru papuci neizolati 16...400mm ²	1	
--------	----------	---	---	--



PRESE PENTRU PAPUCI IZOLATI

COD DABLEROM	COD PRODUCATOR	DENUMIRE	PAC.	PRET €
--------------	----------------	----------	------	--------

presa cu clichet				
03-074	915-6	pentru papuci izolati 0.25...6mm ²	20/10	



presa cu clichet pentru papuci pin				
03-075	915-62	pentru papuci pin 1...6mm ²	20/10	

**PRESE PENTRU MUFE TELEFON/CALCULATOR**

COD DABLEROM	COD PRODUCATOR	DENUMIRE	PAC.	PRET €
--------------	----------------	----------	------	--------

presa mecanica pentru mufe telefon				
03-061	17-1	pentru mufe 6P2C , 6P4C , 6P6C	80/1	



presa mecanica pentru mufe calculator				
03-062	17-3	pentru mufe 8P8C (RJ-45)	64/8	



presa mecanica pentru mufe receptor si telefon				
03-063	17-2	pentru mufe 4P4C , 6P6C	50/1	



presa mecanica pentru mufe telefon si calculator				
03-064	17-4	pentru mufe 6P6C , 8P8C (RJ-45)	40/10	



presa cu clichet pentru mufe receptor, telefon si calculator				
03-065	17-5	pentru mufe 4P4C , 6P6C , 8P8C (RJ-45)	40/10	



SCULE - NWS SOLINGEN GERMANY

nws
PRODUKTION
SOLINGEN
GERMANY

196

COD DABLEROM	COD PRODUCATOR	DENUMIRE	PAC.	PRET €
surubelnite tester				
03-008	15-45000	mica transparenta - 110-250V AC	24	
03-009	15-45200	mare transparenta - 110-250V AC	24	



surubelnite drepte - 1000V				
03-260	15-9511	2.5 x 75mm	6	
03-261	15-9513	4 x 100mm	6	
03-262	15-9515	5.5 x 125mm	6	
03-263	15-9517	6.5 x 150mm	6	



surubelnite cruce - 1000V				
03-264	15-9521	No 0 - L:60mm	6	
03-265	15-9522	No 1 - L:80mm	6	
03-266	15-9523	No 2 - L:100mm	6	
03-267	15-9524	No 3 - L:150mm	6	



set 8 surubelnite (4drepte+3cruce+1tester) - 1000V				
03-280	15-0	set 8 surubelnite	1	



truse cu 6 scule(4surubelnite (2drepte+2cruce) +1 patent pensa+1 cleste taiat) - 1000V				
03-282	15-8376	trusa 6 scule	1	



dezizolator-cutit				
03-243	728	dezizolator- cutit - L:170mm	6	



dezizolator pentru cabluri flexibile				
03-245	712	pentru cablu de 3x1.5mm ² ... 5x2.5mm ²	6	



dezizolator cablu automat din plastic				
03-246	704	pentru cablu de 0.5mm ² ... 4mm ²	6	



cutit cu lama dreapta				
03-249	2040	cutit cu lama dreapta - 1000V	6	



cutit pantof cu lama carlig				
03-251	20433	cutit pantof cu lama carlig - 1000V	6	



cheie universala pentru tablouri				
03-254	2005	cu 6 functii	10	



februarie 2012

SCULE - NWS SOLINGEN GERMANY

nws
PRODUKTION
SOLINGEN
GERMANY

197

COD DABLEROM	COD PRODUCATOR	DENUMIRE	PAC.	PRET €
patent pensa				
03-200	11148165	patent pensa - L:165mm	6	
03-201	11148180	patent pensa - L:180mm	6	
03-202	11148205	patent pensa - L:205mm	6	



03-203	109649200	patent pensa curba - L:200mm	6	
--------	-----------	------------------------------	---	--



cleste de taiat				
03-210	13448160	cleste de taiat - L:160mm	6	
03-211	13448180	cleste de taiat - L:180mm	6	
03-212	13748200	cleste de taiat - L:200mm	6	



cleste cu cioc				
03-220	14048205	cleste cu cioc L: 205mm - drept	6	
03-221	14148205	cleste cu cioc L: 205mm - inclinat	6	



cleste pentru taiat cablu				
03-230	04348160	cleste pentru taiat cablu - L:160mm	6	
03-231	04348210	cleste pentru taiat cablu - L:210mm	6	



cleste multifunctional (cuter-dezizolator-presa)				
03-233	13549190	cleste multifunctional - L:190mm	6	



dezizolator (cu cioc in "V")				
03-240	14548160	dezizolator - L:160mm	6	



presa pentru papuci "mini"				
03-252	14362190	presa pentru papuci 0.5...6mm-L:120mm	6	



presa pentru papuci				
03-253	14962235	presa pentru papuci 1.5...6mm-L:235mm	6	



februarie 2012



WIRE 800 - CEF

COD	DIMENSIUNE (mm)	GREUTATE (kg)	PUTERE (kw)	TURAJIE		GREUTATE TOTALĂ ADMISĂ (kg)	DIAMETRU BOBINĂ	
				min	max		Ømin	Ømax
0800.0800	1090X1240	185	1,1	0	70	400	800	600



WIRE 1000 - CEF

COD	DIMENSIUNE (mm)	GREUTATE (kg)	PUTERE (kw)	TURAJIE		GREUTATE TOTALĂ ADMISĂ (kg)	DIAMETRU BOBINĂ	
				min	max		Ømin	Ømax
0800.1000	1680X1480X1780	420	1,1	0	70	700	600	1000



RAPID ROLL METER 1200/2000/4000 - CEF

COD	DIMENSIUNE (mm)	GREUTATE (kg)	PUTERE (kw)	TURAJIE		GREUTATE TOTALĂ ADMISĂ (kg)	DIAMETRU BOBINĂ	
				min	max		Ømin	Ømax
0900.1200	1790X1400X1580	375	1,1	0	70	1500	600	1200
0900.1600	2315X1400X1625	580	2,2	0	47	2000	600	1600
0900.2000	2550X1500X1825	670	3	0	35	4000	600	2000



FAST - CEF

DIMENSIUNE (mm)	GREUTATE (kg)	PUTERE (kw)	TURAJIE		GREUTATE TOTALĂ ADMISĂ (kg)	COD
			min	max		
770X1380X1480	214	1,1	0	70	250	0450



IRON 1600/2500 - CEF

DIMENSIUNE (mm)	GREUTATE (kg)	GREUTATE TOTALĂ ADMISĂ (kg)	DIAMETRU BOBINĂ		COD
			Ø max	Ø min	
500X740X790	19	1500	1600	600	0550.1600
720X1390X1490	62	5000	2500	600	0550.2500



COD	DIMENSIUNE (mm)	GREUTATE (kg)	GREUTATE TOTALĂ ADMISĂ (kg)	DIAMETRU BOBINĂ	
				Ømax	Ømin
0600.1600	1460X1200X1550	190	1500	1600	600
0600.2000	1800X1400X1800	290	4000	2000	600



UNROLL - CEF

COD	DIMENSIUNE (mm)	GREUTATE (kg)	GREUTATE TOTALĂ ADMISĂ (kg)	DIAMETRU BOBINĂ	
				Ømax	Ømin
0500.1200	220X150X1040	16	700	1200	600



ELECTRA - CEF

COD	DIMENSIUNE (mm)	GREUTATE (kg)	PUTERE (kw)	TURAJE		GREUTATE TOTALĂ ADMISĂ (kg)	MECANISM (mm)		MECANISM (mm)					
				min	max		Ømax	Ømin	Ømax	Ømin				
0350	1740X1270X1500	153	0,37	0	100	70	550	110	100	200	550	180	150	210

"ACCESORII"

COD	DIMENSIUNE (mm)	GREUTATE (kg)
0200	550X560X395	14
0210	550X560X315	15

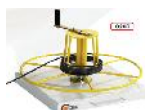

SMALL - CEF

COD	DIMENSIUNE (mm)	GREUTATE (kg)	GREUTATE TOTALĂ ADMISĂ (kg)	MECANISM (mm)		MECANISM (mm)					
				Ømax	Ømin	Ømax	Ømin				
0300	550X285X1200	35	70	550	180	150	200	550	60	300	200



ACCESORII - CEF

"METAL"

COD	DIMENSIUNE (mm)	GREUTATE (kg)	DIAMETRU CABLU	
			Ø max	Ø min
0100	320X150X230	4,5	20	3



"MEDIUM"

COD	DIMENSIUNE (mm)	GREUTATE (kg)	DIAMETRU CABLU	
			Ø max	Ø min
0110	260X340X340	5,5	30	3



"SUPERMETAL"

COD	DIMENSIUNE (mm)	GREUTATE (kg)	DIAMETRU CABLU	
			Ø max	Ø min
0120	376X450X500	17	60	3



0013.0000

0014.0000

0013.0000

0013.0000

0011.0000

0011.0000

0030

0031

0031.0000

0031

0031

0031

0031

0031

0031

0031

0031

0031

0031

0031

0031

0031

VENTILATOARE

200

freder®

COD DABLEROM	COD PRODUCATOR	DENUMIRE	PAC.	PRET €
--------------	----------------	----------	------	--------

ventilatoare de baie - cu grila de inchidere - 220V				
21-V100SC	V100SC	Ø:10cm - 100m³/h - 158x158x77cm	10/1	
21-V120SC	V120SC	Ø:12cm - 150m³/h - 180x180x81cm	10/1	



ventilatoare de baie - cu grila de inchidere si timer - 220V				
21-V100TC	V100TC	Ø:10cm - 100m³/h - 158x158x77cm	10/1	
21-V120TC	V120TC	Ø:12cm - 150m³/h - 180x180x81cm	10/1	

ventilatoare pentru perete - 220V				
22-008	C-500	Ø:21cm - 361m³/h	2/1	

aliberti



ventilatoare pentru perete - 220V				
22-009	B-550	Ø:25cm - 315m³/h	2/1	

ventilatoare de geam - 220V				
22-007	A-600	Ø:26cm - 266m³/h	2/1	



ventilatoare industriale				
22-000	M250	Ø:265mm - 844m³/h - 230V	2/1	
22-001	M300	Ø:315mm - 1736m³/h - 230V	2/1	
22-002	M350	Ø:360mm - 2441m³/h - 230V	2/1	
22-003	M400	Ø:415mm - 2851m³/h - 230V	2/1	
22-003/2	M400/2	Ø:415mm - 2851m³/h - 230V - 2 SENSURI	2/1	
22-003/3	M400/3	Ø:415mm - 2851m³/h - 380V	2/1	
21-VO450S	VO450S	Ø:455mm - 5700m³/h - 230V	2/1	

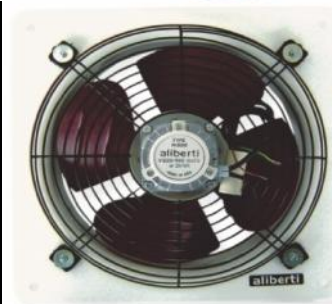

ventilatoare industriale VKO				
21-VKO160	VKO160	Ø:160mm - 140m³/h - 230V	2/1	
21-VKO200	VKO200	Ø:207mm - 400m³/h - 230V	2/1	
21-VKO250	VKO250	Ø:245mm - 820m³/h - 230V	2/1	
21-VKO300	VKO300	Ø:310mm - 1400m³/h - 230V	2/1	

freder®

