

TOPRAKLI 2'Lİ GRUP PRİZ / GROUNDED 2-GANG SOCKET

Удлинитель на 2 гнезда С/З

250V~50Hz
16A



200-200-201 Grounded 2-gang socket

Quantity in Box	1
Quantity in Carton	36
Carton (N/G) Weight Kg	3,12 / 3,50
Carton m ³	0,013

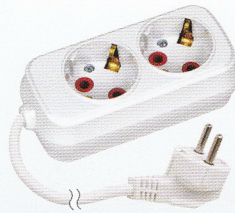

200-202-201 Grounded 2-gang socket 2m

Quantity in Box	1
Quantity in Carton	12
Carton (N/G) Weight Kg	3,55 / 3,93
Carton m ³	0,014

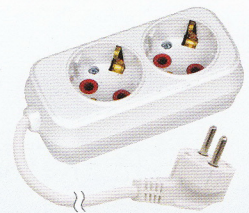

200-203-201 Grounded 2-gang socket 3m

Quantity in Box	1
Quantity in Carton	12
Carton (N/G) Weight Kg	4,60 / 4,97
Carton m ³	0,014

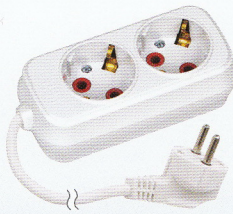

200-205-201 Grounded 2-gang socket 5m

Quantity in Box	1
Quantity in Carton	12
Carton (N/G) Weight Kg	6,61 / 6,98
Carton m ³	0,015



200-207-201 Grounded 2-gang socket 7m

Quantity in Box	1
Quantity in Carton	12
Carton (N/G) Weight Kg	9,33 / 9,70
Carton m ³	0,020



200-210-201 Grounded 2-gang socket 10m

Quantity in Box	1
Quantity in Carton	12
Carton (N/G) Weight Kg	12,53 / 12,90
Carton m ³	0,027

TOPRAKSIZ 2'Lİ GRUP PRİZ / UNGROUNDED 2-GANG SOCKET

Удлинитель на 2 гнезда Б/З

250V~50Hz
10A



200-200-203 Ungrounded 2-gang socket

Quantity in Box	1
Quantity in Carton	36
Carton (N/G) Weight Kg	3,13 / 2,75
Carton m ³	0,013

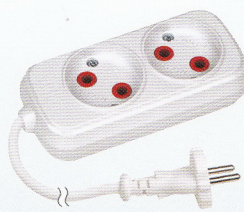

200-202-203 Ungrounded 2-gang socket 2m

Quantity in Box	1
Quantity in Carton	12
Carton (N/G) Weight Kg	3,35 / 2,97
Carton m ³	0,014

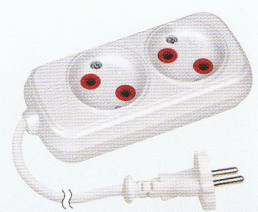

200-203-203 Ungrounded 2-gang socket 3m

Quantity in Box	1
Quantity in Carton	12
Carton (N/G) Weight Kg	4,14 / 3,76
Carton m ³	0,014

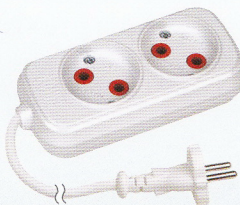

200-205-203 Ungrounded 2-gang socket 5m

Quantity in Box	1
Quantity in Carton	12
Carton (N/G) Weight Kg	5,78 / 5,40
Carton m ³	0,014

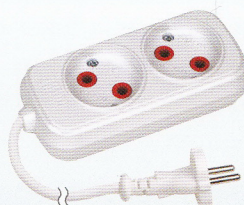

200-207-203 Ungrounded 2-gang socket 7m

Quantity in Box	1
Quantity in Carton	12
Carton (N/G) Weight Kg	7,74 / 7,01
Carton m ³	0,020

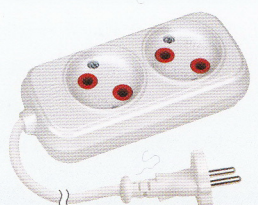

200-210-203 Ungrounded 2-gang socket 10m

Quantity in Box	1
Quantity in Carton	12
Carton (N/G) Weight Kg	10,09 / 9,36
Carton m ³	0,020

TOPRAKLI 3'LÜ GRUP PRİZ / GROUNDED 3-GANG SOCKET

Удлинитель на 3 гнезда С/З

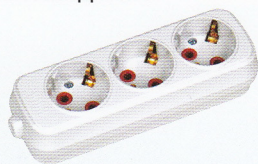
250V~50Hz
16A**200-300-301** Grounded 3-gang socketed

Quantity in Box	1
Quantity in Carton	36
Carton (N/G) Weight Kg	4,23 / 4,71
Carton m ³	0,018

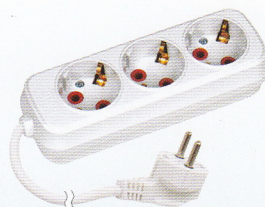
**200-302-301** Grounded 3-gang socketed 2m

Quantity in Box	1
Quantity in Carton	12
Carton (N/G) Weight Kg	3,98 / 4,34
Carton m ³	0,013

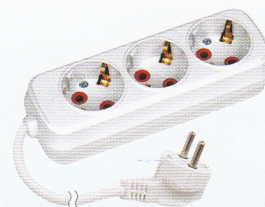
**200-303-301** Grounded 3-gang socketed 3m

Quantity in Box	1
Quantity in Carton	12
Carton (N/G) Weight Kg	4,97 / 5,33
Carton m ³	0,014

**200-305-301** Grounded 3-gang socketed 5m

Quantity in Box	1
Quantity in Carton	12
Carton (N/G) Weight Kg	7,10 / 7,47
Carton m ³	0,015

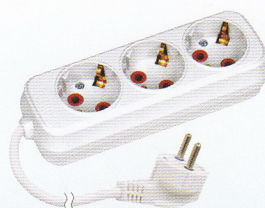
**200-307-301** Grounded 3-gang socketed 7m

Quantity in Box	1
Quantity in Carton	12
Carton (N/G) Weight Kg	9,46 / 9,82
Carton m ³	0,021

**200-310-301** Grounded 3-gang socketed 10m

Quantity in Box	1
Quantity in Carton	12
Carton (N/G) Weight Kg	10,03 / 10,39
Carton m ³	0,021

TOPRAKLI 3'LÜ ANAHTARLI GRUP PRİZ / GROUNDED 3-GANG SOCKET WITH SWITCH

Удлинитель на 3 гнезда С/З с Выкл.

250V~50Hz
16A**200-300-302** Grounded 3-gang socketed with switch

Quantity in Box	1
Quantity in Carton	36
Carton (N/G) Weight Kg	5,29 / 5,81
Carton m ³	0,022

**200-302-302** Grounded 3-gang socketed with switch 2m

Quantity in Box	1
Quantity in Carton	12
Carton (N/G) Weight Kg	4,30 / 4,67
Carton m ³	0,015

**200-303-302** Grounded 3-gang socketed with switch 3m

Quantity in Box	1
Quantity in Carton	12
Carton (N/G) Weight Kg	5,30 / 5,67
Carton m ³	0,015

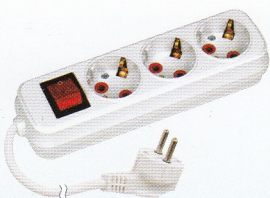
**200-305-302** Grounded 3-gang socketed with switch 5m

Quantity in Box	1
Quantity in Carton	12
Carton (N/G) Weight Kg	7,76 / 8,22
Carton m ³	0,015

**200-307-302** Grounded 3-gang socketed with switch 7m

Quantity in Box	1
Quantity in Carton	12
Carton (N/G) Weight Kg	10,06 / 10,42
Carton m ³	0,020

**200-310-302** Grounded 3-gang socketed with switch 10m

Quantity in Box	1
Quantity in Carton	12
Carton (N/G) Weight Kg	13,30 / 13,88
Carton m ³	0,027

TOPRAKSIZ 3'LÜ GRUP PRİZ / UNGROUNDED 3-GANG SOCKET

Удлинитель на 3 гнезда Б/З

250V~50Hz
10A

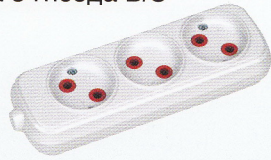

200-300-303 Ungrounded 3-gang socketed

Quantity in Box	1
Quantity in Carton	36
Carton (N/G) Weight Kg	3,29 / 3,68
Carton m ³	0,014

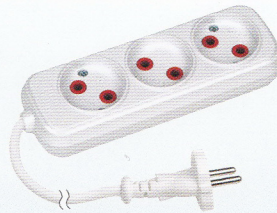

200-302-303 Ungrounded 3-gang socketed 2m

Quantity in Box	1
Quantity in Carton	12
Carton (N/G) Weight Kg	2,89 / 3,25
Carton m ³	0,014

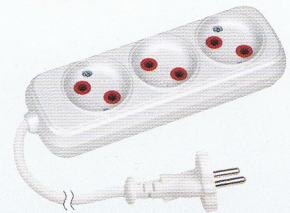

200-303-303 Ungrounded 3-gang socketed 3m

Quantity in Box	1
Quantity in Carton	12
Carton (N/G) Weight Kg	3,64 / 4,00
Carton m ³	0,014



200-305-303 Ungrounded 3-gang socketed 5m

Quantity in Box	1
Quantity in Carton	12
Carton (N/G) Weight Kg	5,14 / 5,50
Carton m ³	0,014

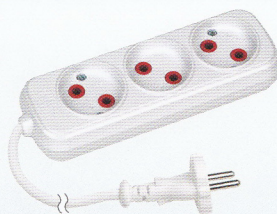

200-307-303 Ungrounded 3-gang socketed 7m

Quantity in Box	1
Quantity in Carton	12
Carton (N/G) Weight Kg	7,27 / 7,63
Carton m ³	0,021

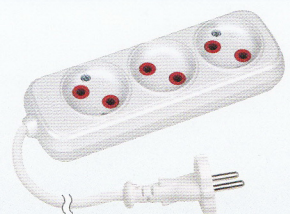

200-310-303 Ungrounded 3-gang socketed 10m

Quantity in Box	1
Quantity in Carton	12
Carton (N/G) Weight Kg	9,60 / 9,96
Carton m ³	0,021

TOPRAKSIZ 4'LÜ GRUP PRİZ / UNGROUNDED 4-GANG SOCKET

Удлинитель на 4 гнезда Б/З

250V~50Hz
10A

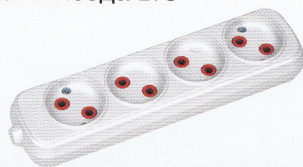

200-400-403 Ungrounded 4-gang socketed

Quantity in Box	1
Quantity in Carton	36
Carton (N/G) Weight Kg	4,27 / 4,75
Carton m ³	0,017

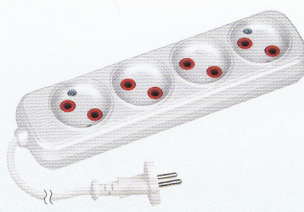

200-402-403 Ungrounded 4-gang socketed 2m

Quantity in Box	1
Quantity in Carton	12
Carton (N/G) Weight Kg	3,23 / 3,59
Carton m ³	0,014

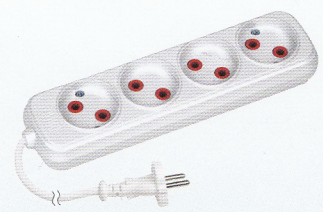

200-403-403 Ungrounded 4-gang socketed 3m

Quantity in Box	1
Quantity in Carton	12
Carton (N/G) Weight Kg	4,00 / 4,36
Carton m ³	0,014

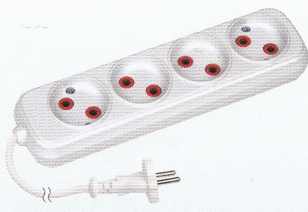

200-405-403 Ungrounded 4-gang socketed 5m

Quantity in Box	1
Quantity in Carton	12
Carton (N/G) Weight Kg	5,51 / 5,87
Carton m ³	0,014

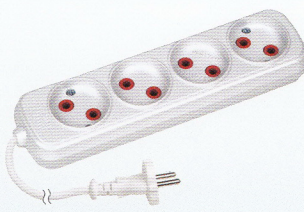

200-407-403 Ungrounded 4-gang socketed 7m

Quantity in Box	1
Quantity in Carton	12
Carton (N/G) Weight Kg	7,51 / 7,96
Carton m ³	0,020

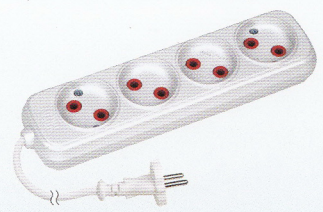

200-410-403 Ungrounded 4-gang socketed 10m

Quantity in Box	1
Quantity in Carton	12
Carton (N/G) Weight Kg	10,01 / 10,72
Carton m ³	0,020

TOPRAKLI 4'LÜ GRUP PRİZ / GROUNDED 4-GANG SOCKET

Удлинитель на 3 гнезда C/3

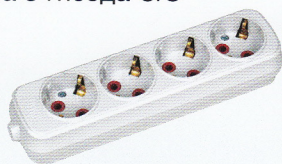
**250V~50Hz
16A****200-400-401** Grounded 3-gang socketed

Quantity in Box	1
Quantity in Carton	36
Carton (N/G) Weight Kg	5,42 / 5,94
Carton m ³	0,022

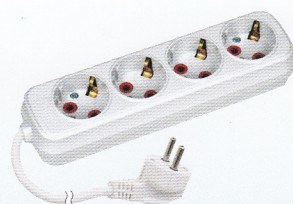
**200-402-401** Grounded 3-gang socketed 2m

Quantity in Box	1
Quantity in Carton	12
Carton (N/G) Weight Kg	4,36 / 4,73
Carton m ³	0,015

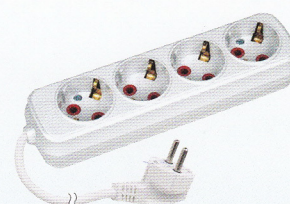
**200-403-401** Grounded 3-gang socketed 3m

Quantity in Box	1
Quantity in Carton	12
Carton (N/G) Weight Kg	5,38 / 5,75
Carton m ³	0,015

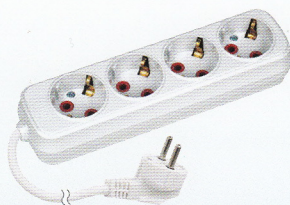
**200-405-401** Grounded 3-gang socketed 5m

Quantity in Box	1
Quantity in Carton	12
Carton (N/G) Weight Kg	7,41 / 7,86
Carton m ³	0,015

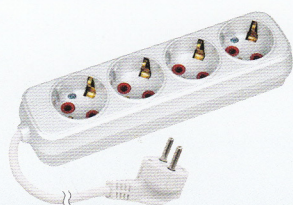
**200-407-401** Grounded 3-gang socketed 7m

Quantity in Box	1
Quantity in Carton	12
Carton (N/G) Weight Kg	10,10 / 10,46
Carton m ³	0,020

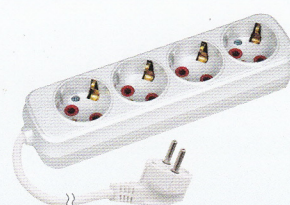
**200-410-401** Grounded 3-gang socketed 10m

Quantity in Box	1
Quantity in Carton	12
Carton (N/G) Weight Kg	13,34 / 14,04
Carton m ³	0,020

TOPRAKLI 4'LÜ ANAHTARLI GRUP PRİZ / GROUNDED 4-GANG SOCKET WITH SWITCH

Удлинитель на 4 гнезда C/3 с Выкл.

**250V~50Hz
16A****200-400-402** Grounded 3-gang socketed with switch

Quantity in Box	1
Quantity in Carton	36
Carton (N/G) Weight Kg	6,77 / 7,33
Carton m ³	0,024

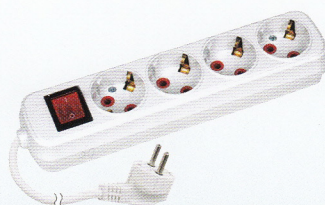
**200-402-402** Grounded 3-gang socketed with switch 2m

Quantity in Box	1
Quantity in Carton	12
Carton (N/G) Weight Kg	4,74 / 5,20
Carton m ³	0,020

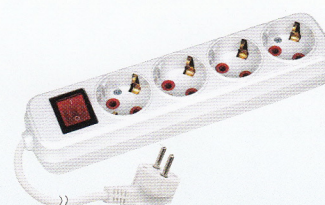
**200-403-402** Grounded 3-gang socketed with switch 3m

Quantity in Box	1
Quantity in Carton	12
Carton (N/G) Weight Kg	5,78 / 6,23
Carton m ³	0,020

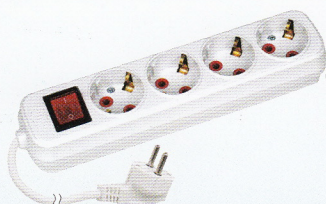
**200-405-402** Grounded 3-gang socketed with switch 5m

Quantity in Box	1
Quantity in Carton	12
Carton (N/G) Weight Kg	7,83 / 8,28
Carton m ³	0,020

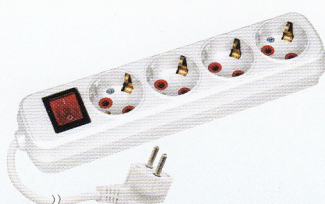
**200-407-402** Grounded 3-gang socketed with switch 7m

Quantity in Box	1
Quantity in Carton	12
Carton (N/G) Weight Kg	10,29 / 10,74
Carton m ³	0,020

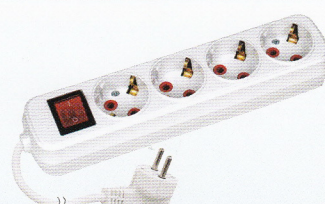
**200-410-402** Grounded 3-gang socketed with switch 10m

Quantity in Box	1
Quantity in Carton	12
Carton (N/G) Weight Kg	13,91 / 14,62
Carton m ³	0,034

TOPRAKLI 6'LI GRUP PRİZ / GROUNDED 6-GANG SOCKET
УДЛИНИТЕЛЬ НА 6 ГНЕЗД С/З

250V~50Hz
16A

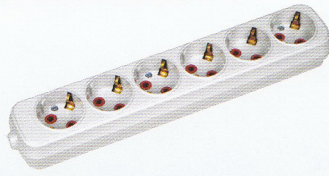

200-600-601 Grounded 6-gang socket

Quantity in Box	1
Quantity in Carton	36
Carton (N/G) Weight Kg	8,14 / 8,85
Carton m ³	0,022

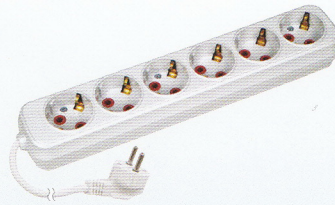

200-602-601 Grounded 6-gang socket 2m

Quantity in Box	1
Quantity in Carton	12
Carton (N/G) Weight Kg	5,26 / 5,85
Carton m ³	0,027

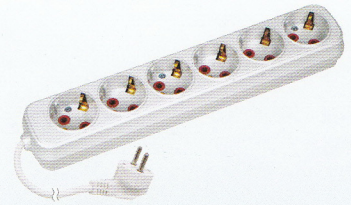

200-603-601 Grounded 6-gang socket 3m

Quantity in Box	1
Quantity in Carton	12
Carton (N/G) Weight Kg	6,46 / 7,14
Carton m ³	0,027

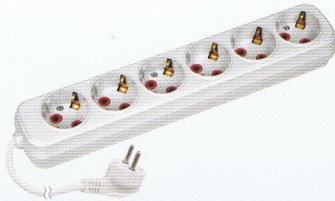

200-605-601 Grounded 6-gang socket 5m

Quantity in Box	1
Quantity in Carton	12
Carton (N/G) Weight Kg	8,21 / 8,79
Carton m ³	0,027

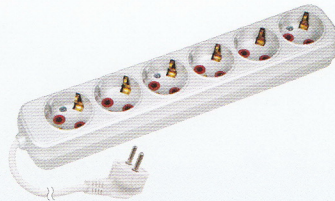

200-607-601 Grounded 6-gang socket 7m

Quantity in Box	1
Quantity in Carton	12
Carton (N/G) Weight Kg	10,91 / 11,49
Carton m ³	0,027

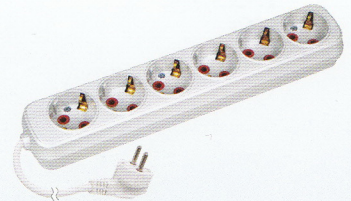

200-610-601 Grounded 6-gang socket 10m

Quantity in Box	1
Quantity in Carton	12
Carton (N/G) Weight Kg	14,25 / 14,83
Carton m ³	0,034

TOPRAKLI 6'LI ANAHTARLI GRUP PRİZ / GROUNDED 6-GANG SOCKET WITH SWITCH
УДЛИНИТЕЛЬ НА 6 ГНЕЗД С/З с ВЫКЛ

250V~50Hz
16A

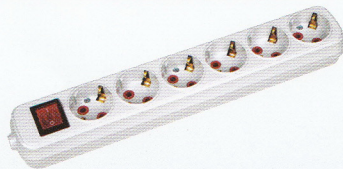

200-600-602 Grounded 6-gang socket with switch

Quantity in Box	1
Quantity in Carton	36
Carton (N/G) Weight Kg	9,02 / 9,72
Carton m ³	0,024

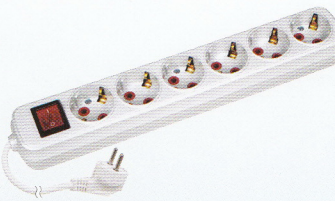

200-602-602 Grounded 6-gang socket with switch 2m

Quantity in Box	1
Quantity in Carton	12
Carton (N/G) Weight Kg	5,49 / 6,07
Carton m ³	0,027

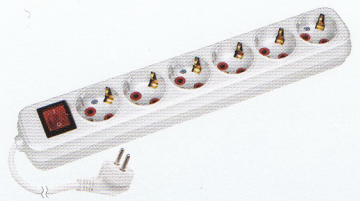

200-603-602 Grounded 6-gang socket with switch 3m

Quantity in Box	1
Quantity in Carton	12
Carton (N/G) Weight Kg	6,56 / 7,14
Carton m ³	0,027

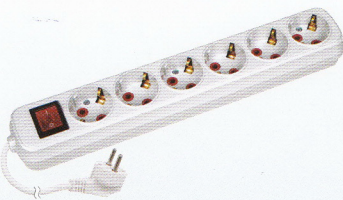

200-605-602 Grounded 6-gang socket with switch 5m

Quantity in Box	1
Quantity in Carton	12
Carton (N/G) Weight Kg	8,56 / 9,14
Carton m ³	0,027

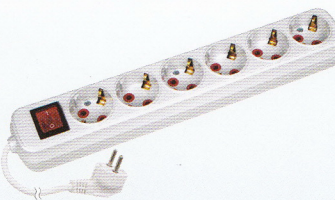

200-607-602 Grounded 6-gang socket with switch 7m

Quantity in Box	1
Quantity in Carton	12
Carton (N/G) Weight Kg	11,19 / 11,77
Carton m ³	0,027

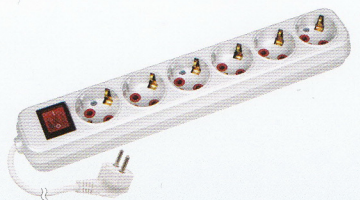

200-610-602 Grounded 6-gang socket with switch 10m

Quantity in Box	1
Quantity in Carton	12
Carton (N/G) Weight Kg	14,49 / 15,07
Carton m ³	0,034

TOPRAKSIZ UZATMA TAKIMI / UNGROUNDED EXTENSION KIT

Удлинитель кабеля без заземления

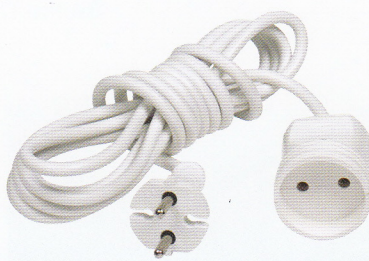
250V~50Hz
10A**300-003-800**
Ungrounded extension kit 3m

Quantity in Box	1
Quantity in Carton	12
Carton (N/G) Weight Kg	3,16 / 3,63
Carton m ³	0,016

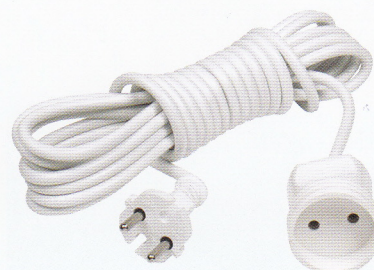
**300-005-800**
Ungrounded extension kit 5m

Quantity in Box	1
Quantity in Carton	12
Carton (N/G) Weight Kg	4,72 / 5,19
Carton m ³	0,016

TOPRAKLI UZATMA TAKIMI / GROUNDED EXTENSION KIT

Удлинитель кабеля с заземления

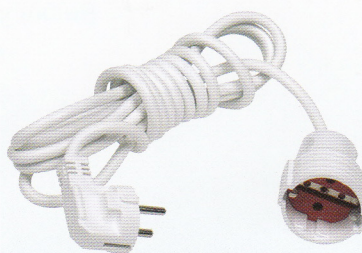
250V~50Hz
16A**300-003-801**
Grounded extension kit 3m

Quantity in Box	1
Quantity in Carton	12
Carton (N/G) Weight Kg	4,33 / 4,80
Carton m ³	0,014

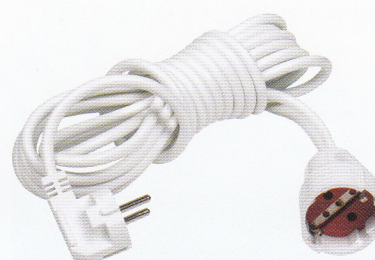
**300-005-801**
Grounded extension kit 5m

Quantity in Box	1
Quantity in Carton	12
Carton (N/G) Weight Kg	6,37 / 6,84
Carton m ³	0,015



TOPRAKSIZ ERKEK FIŞ

UNGROUNDED MALE PLUG

Вилка Б/3

250V~50Hz
10A

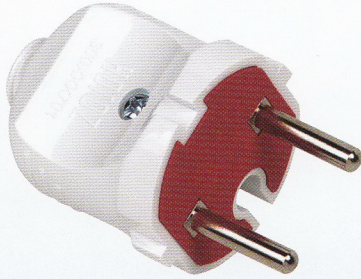

300-000-701 Ungrounded male plug

Quantity in Box	100
Quantity in Carton	800
Carton (N/G) Weight Kg	18,19 / 18,93
Carton m ³	0,049

TOPRAKLI ERKEK FIŞ

GROUNDING MALE PLUG

Вилка С/3

250V~50Hz
16A

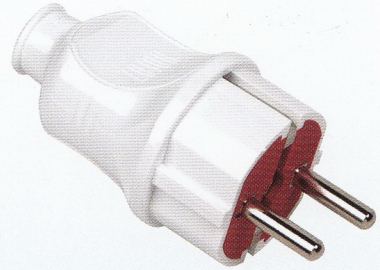

300-000-702 Grounded male plug

Quantity in Box	50
Quantity in Carton	400
Carton (N/G) Weight Kg	14,36 / 15,10
Carton m ³	0,049

KULPLU TOPRAKLI ERKEK FIŞ

GROUNDING MALE PLUG WITH HANDLE

Вилка угловая с ушком С/3

250V~50Hz
16A

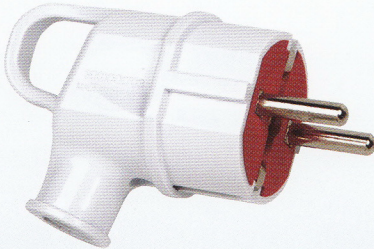

300-000-703 Grounded male plug with handle

Quantity in Box	50
Quantity in Carton	400
Carton (N/G) Weight Kg	15,20 / 15,94
Carton m ³	0,049

TOPRAKLI L TIPI FIŞ

GROUNDING L TYPE PLUG

Вилка угловая С/3

250V~50Hz
16A

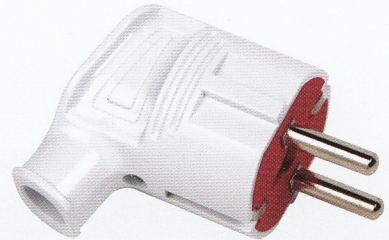

300-000-704 Grounded L type plug

Quantity in Box	50
Quantity in Carton	400
Carton (N/G) Weight Kg	13,81 / 14,55
Carton m ³	0,049

TOPRAKSIZ DIŞI FIŞ

UNGROUNDING FEMALE PLUG

Штепсельное гнездо Б/3

250V~50Hz
10A



300-000-705 Ungrounded female plug

Quantity in Box	50
Quantity in Carton	400
Carton (N/G) Weight Kg	13,83 / 15,30
Carton m ³	0,049

TOPRAKLI DIŞI FIŞ

GROUNDING FEMALE PLUG

Штепсельное гнездо С/3

250V~50Hz
16A

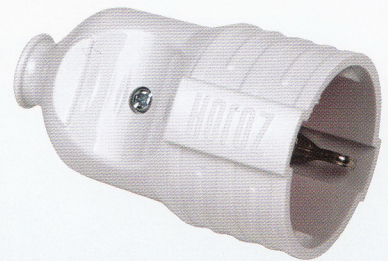

300-000-706 Grounded female plug

Quantity in Box	36
Quantity in Carton	288
Carton (N/G) Weight Kg	12,75 / 13,60
Carton m ³	0,049

TOPRAKLI 3'LÜ FİŞ PRİZ (GOLYAD) / GROUNDED 3-GANG PLUG SOCKED (GOLYAD)
 GOLYAD Тройная розетка C/3

250V~50Hz
16A

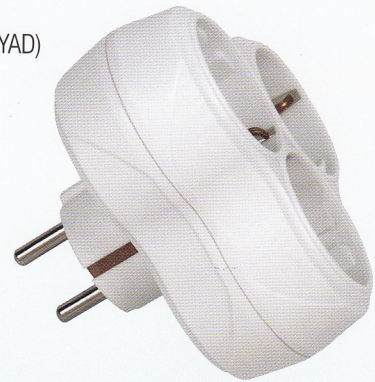

300-000-707 Grounded 3-gang plug socked (golyad)

Quantity in Box	1
Quantity in Carton	40
Carton (N/G) Weight Kg	4,02 / 4,56
Carton m³	0,026

TOPRAKSIZ 3'LÜ FİŞ PRİZ (GOLYAD) / UNGROUNDED 3-GANG PLUG SOCKED (GOLYAD)
 GOLYAD тройная розетка без заземления

250V~50Hz
10A

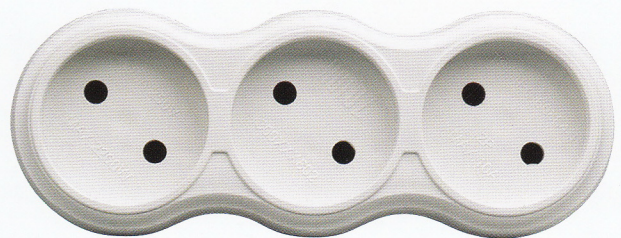

300-000-802 Ungrounded 3-gang plug socked (golyad)

Quantity in Box	1
Quantity in Carton	40
Carton (N/G) Weight Kg	2,31 / 2,81
Carton m³	0,022

ARAPUAR ANAHTAR

HAND SWITCH

Выключатель для бра

250V~50Hz
10A

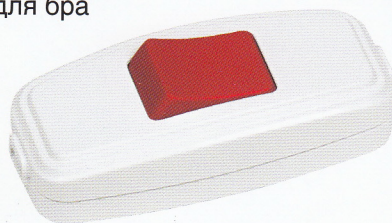
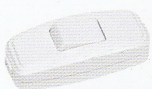

300-001-708 Hand switch (white)
300-002-708 Hand switch (white-red)
300-003-708 Hand switch (black-red)

Quantity in Box	120
Quantity in Carton	960
Carton (N/G) Weight Kg	18,03 / 19,50
Carton m³	0,049

İŞIKLI ANAHTAR

ROCKERSWITCH

Выключатель

T125
250V~50Hz
16A

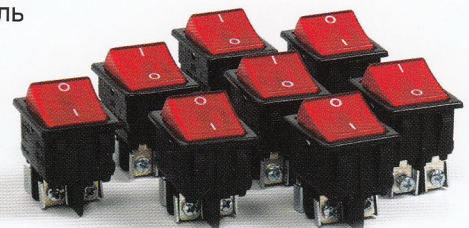

300-000-709 Rockerswitch

Quantity in Box	150
Quantity in Carton	1200
Carton (N/G) Weight Kg	20,641 / 21,380
Carton m³	0,049



NEMLİ YER AYDINLATMA / WATERPROOF FIXTURE / Водонепроницаемый светильник

AQUA OPAL / AQUA OPAL / **AQUA OPAL**



400-010-105 Aqua Opal Waterproof (White)



400-011-105 Aqua Opal Waterproof (Black)



400-012-105 Aqua Opal Waterproof (Grey)

230V~50Hz
Max 60W

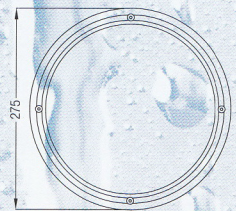
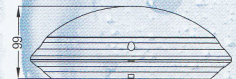

Quantity in Box	1
Quantity in Carton	10
Carton (N/G) Weight Kg	6,056 / 7,567
Carton m³	0,083

AQUA OVAL OPAL / AQUA OPAL OVAL / **AQUA OPAL** Овальный



400-010-106 Aqua Oval Opal Waterproof (White)

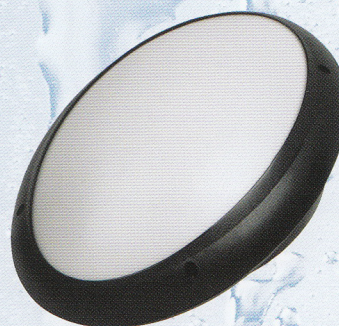

400-011-106 Aqua Oval Opal Waterproof (Black)

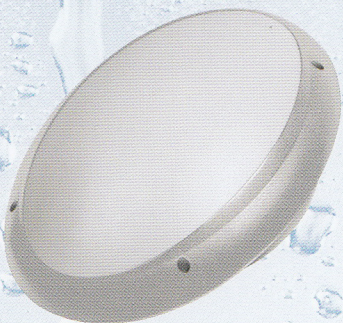

400-012-106 Aqua Oval Opal Waterproof (Grey)

230V~50Hz
Max 60W

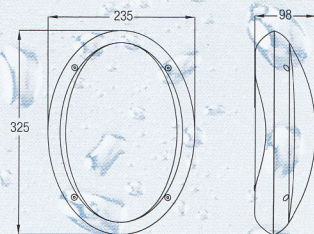

Quantity in Box	1
Quantity in Carton	10
Carton (N/G) Weight Kg	6.780 / 7.855
Carton m³	0,077

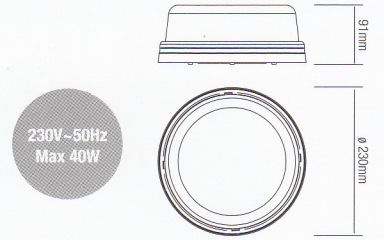
GLOP / GLOP / ГЛОП**400-001-100** GLOP Rüzgar Gülü**400-002-100** GLOP Favori

Quantity in Box	4
Quantity in Carton	32
Carton (N/G) Weight Kg	11,28 / 11,52
Carton m ³	0,085

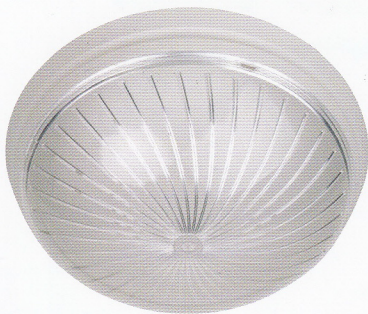
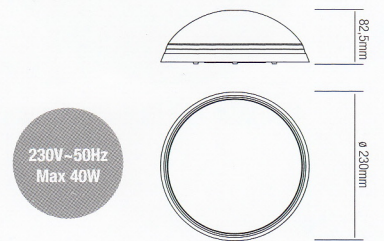
UFO / UFO / УФО**400-001-101** UFO Rüzgar Gülü**400-002-101** UFO Nazar**400-022-101** UFO Yıldız**400-003-101** UFO Zagrep**400-004-101** UFO Erciyes

Quantity in Box	5
Quantity in Carton	40
Carton (N/G) Weight Kg	11,42 / 11,66
Carton m ³	0,085



APLIK / WALL FIXTURE / БРА



400-000-107 Flue Wall Fixture (White)



400-001-107 Flue Wall Fixture (Silver)



400-002-107 Flue Wall Fixture (Fume)



400-003-107 Flue Wall Fixture (Walnut)



400-004-107 Flue Wall Fixture (Maple)

Quantity in Box	4
Quantity in Carton	36
Carton (N/G) Weight Kg	8,012 / 9,276
Carton m ³	0,077

230V~50Hz
Max 26W
(ESL)

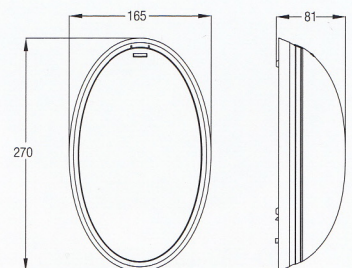

APLIK / WALL FIXTURE / БРА



400-010-107 Ninova Wall Fixture (White)



400-011-107 Ninova Wall Fixture (Silver)



400-012-107 Ninova Wall Fixture (Fume)



400-013-107 Ninova Wall Fixture (Walnut)



400-014-107 Ninova Wall Fixture (Maple)

Quantity in Box	4
Quantity in Carton	36
Carton (N/G) Weight Kg	8,012 / 9,276
Carton m³	0,077

**230V~50Hz
Max 26W
(ESL)**

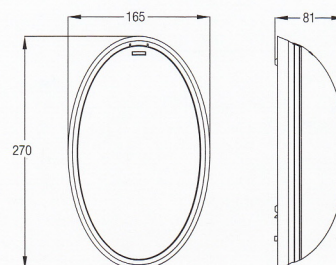



KARE KLASİK / SQUARE CLASSIC / КВАДРАТНАЯ КЛАССИКА

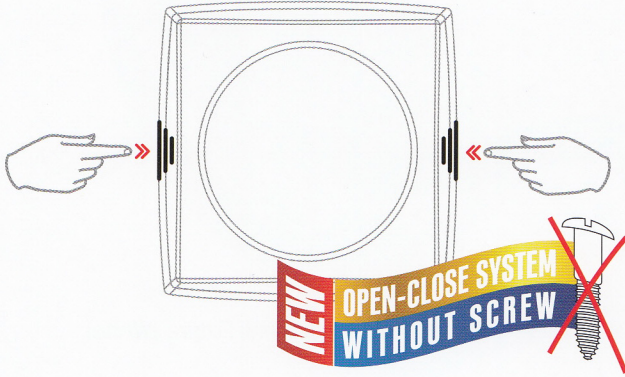

400-000-102 SQUARE CLASSIC (White)



400-010-102 SQUARE CLASSIC (Silver)



400-020-102 SQUARE CLASSIC (Golden)



400-030-102 SQUARE CLASSIC (Walnut)



400-040-102 SQUARE CLASSIC (Maple)

	Tekli	Dörtlü
Quantity in Box	1	4
Quantity in Carton	12	24
Carton (N/G) Weight Kg	4,78 / 6,21	8,98 / 9,78
Carton m ³	0,066	0,060

230V~50Hz
Max 26W
(ESL)

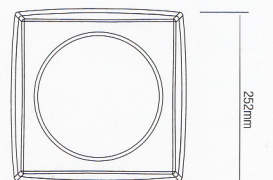
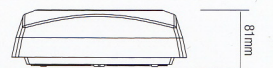

KARE MODERN / SQUARE MODERN / **КВАДРАТНАЯ МОДЕРН**

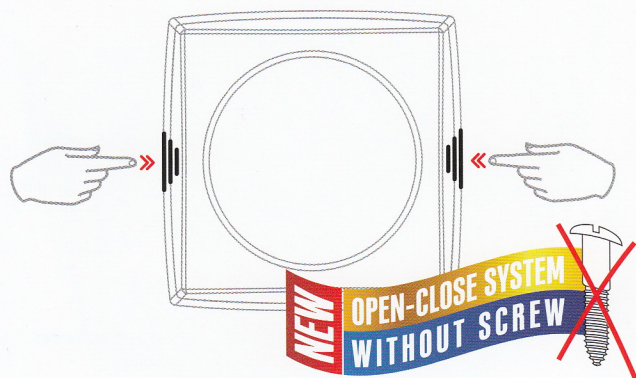

400-001-102 SQUARE MODERN (White)



400-011-102 SQUARE MODERN (Silver)



400-021-102 SQUARE MODERN (Golden)



400-031-102 SQUARE MODERN (Walnut)



400-041-102 SQUARE MODERN (Maple)

	Tekli	Dörtü
Quantity in Box	1	4
Quantity in Carton	12	24
Carton (N/G) Weight Kg	4,67 / 6,10	8,62 / 9,42
Carton m ³	0,066	0,060

230V - 50Hz
Max 26W
(ESL)

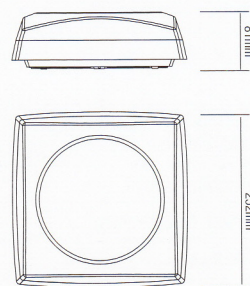



PLASTİK AYDINLATMA / PLASTIC FIXTURE / ПОТОЛОЧНЫЙ СВЕТИЛЬНИК

ÇİFT DUYLU KARE KLASİK / SQUARE CLASSIC WITH DOUBLE LAMP HOLDER / **ДВОЙНОЙ КВАДРАТНЫЙ КЛАССИКА**

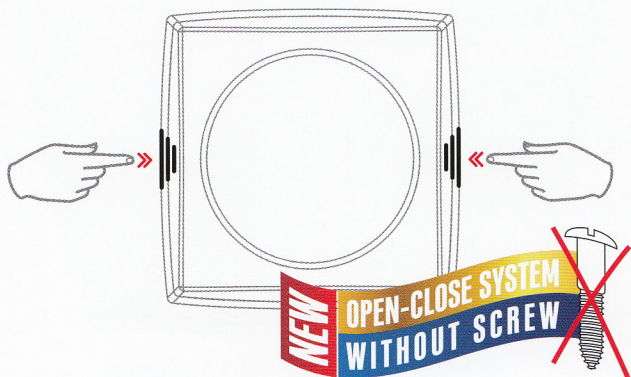

400-000-103 SQUARE CLASSIC (White)



400-010-103 SQUARE CLASSIC (Silver)

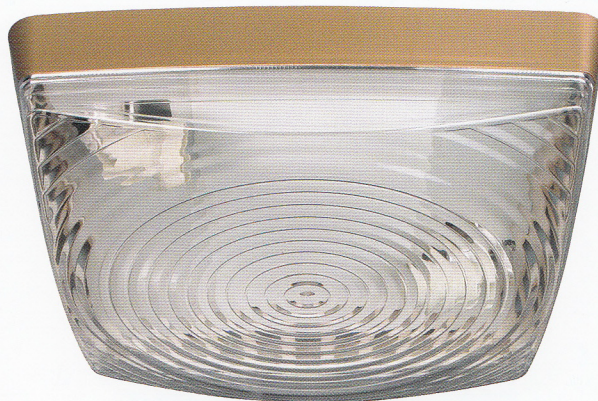

400-020-103 SQUARE CLASSIC (Golden)



400-030-103 SQUARE CLASSIC (Walnut)



400-040-103 SQUARE CLASSIC (Maple)

Quantity in Box	1
Quantity in Carton	10
Carton (N/G) Weight Kg	8,51 / 9,71
Carton m ³	0,102

230V~50Hz
Max 2x26W
(ESL)

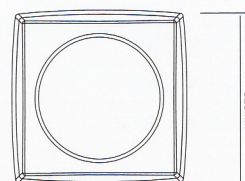
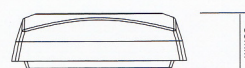

ÇİFT DUYLU KARE MODERN / SQUARE MODERN WITH DOUBLE LAMP HOLDER / ДВОЙНОЙ КВАДРАТНЫЙ МОДЕРН

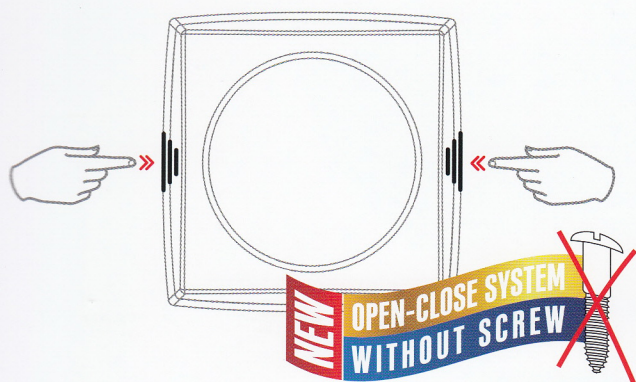

400-001-103 SQUARE MODERN (White)



400-011-103 SQUARE MODERN (Silver)



400-021-103 SQUARE MODERN (Golden)



400-031-103 SQUARE MODERN (Walnut)



400-041-103 SQUARE MODERN (Maple)

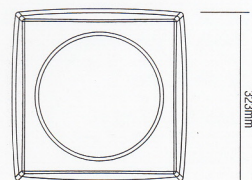
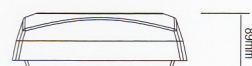

Quantity in Box	1
Quantity in Carton	10
Carton (N/G) Weight Kg	8,44 / 9,64
Carton m ³	0,102

230V~50Hz
Max 2x26W
(ESL)



ÇİFT DUYLU UFO / UFO WITH DOUBLE LAMPHOLDER / ДВОЙНОЙ УФО



400-000-104 Ufo BULUT (White)



400-010-104 Ufo BULUT (Silver)



400-020-104 Ufo BULUT (Golden)



400-030-104 Ufo BULUT (Walnut)



400-040-104 Ufo BULUT (Maple)

Quantity in Box	1
Quantity in Carton	5
Carton (N/G) Weight Kg	3,50 / 4,90
Carton m ³	0,089

230V~50Hz
Max 2x26W
(ESL)

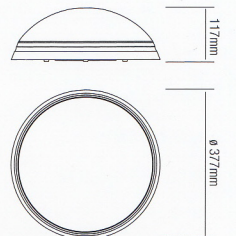

ÇİFT DUYLU UFO / UFO WITH DOUBLE LAMPHOLDER / **двойной уфо**



400-001-104 Ufo ZAGREP (White)



400-011-104 Ufo ZAGREP (Silver)



400-021-104 Ufo ZAGREP (Golden)



400-031-104 Ufo ZAGREP (Walnut)



400-041-104 Ufo ZAGREP (Maple)

Quantity in Box	1
Quantity in Carton	5
Carton (N/G) Weight Kg	3,50 / 4,90
Carton m³	0,089

**230V~50Hz
Max 2x26W
(ESL)**

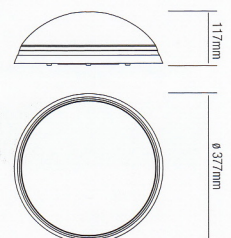

TEKNİK ŞEMA / TECHNICAL SCHEMA / ТЕХНИЧЕСКАЯ СХЕМА

PC Glow Wire 850°C

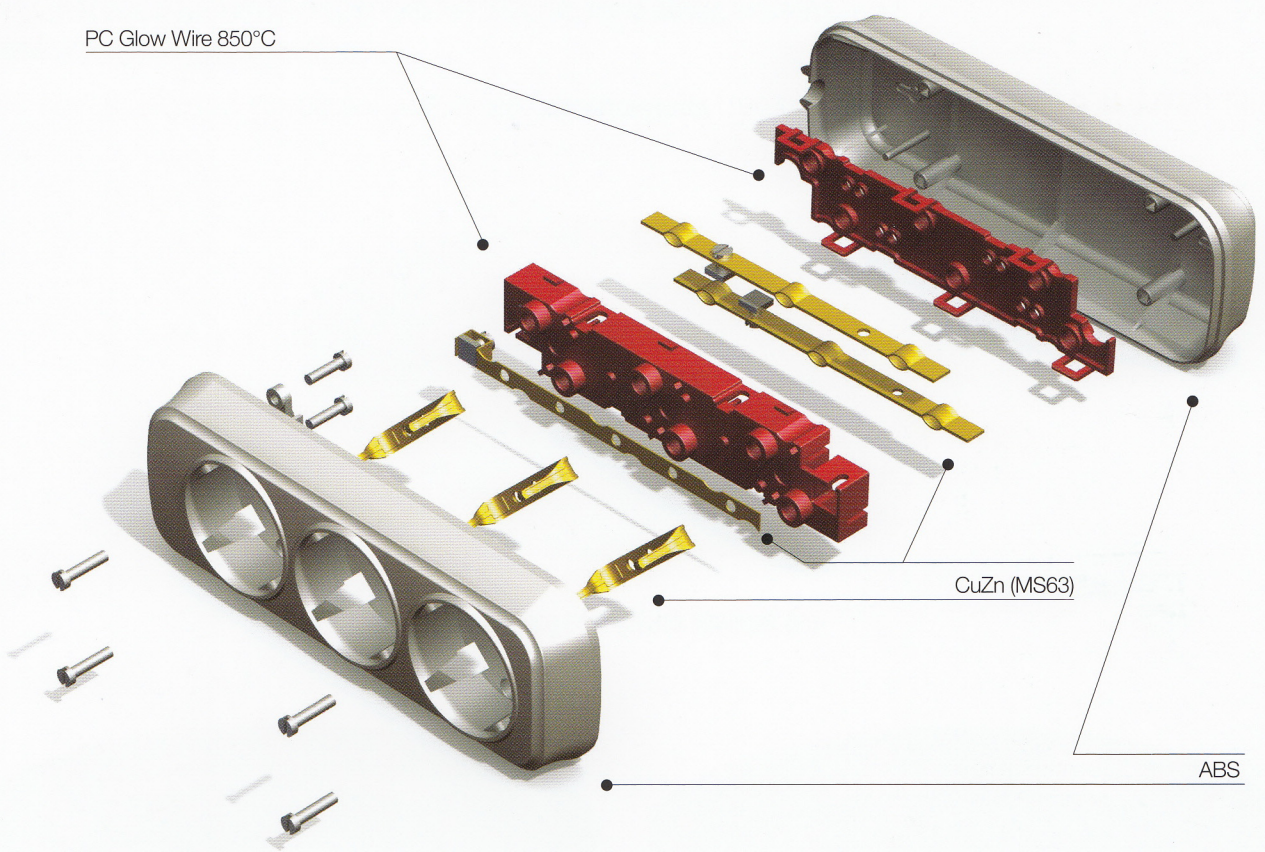

CuZn (MS63)

ABS

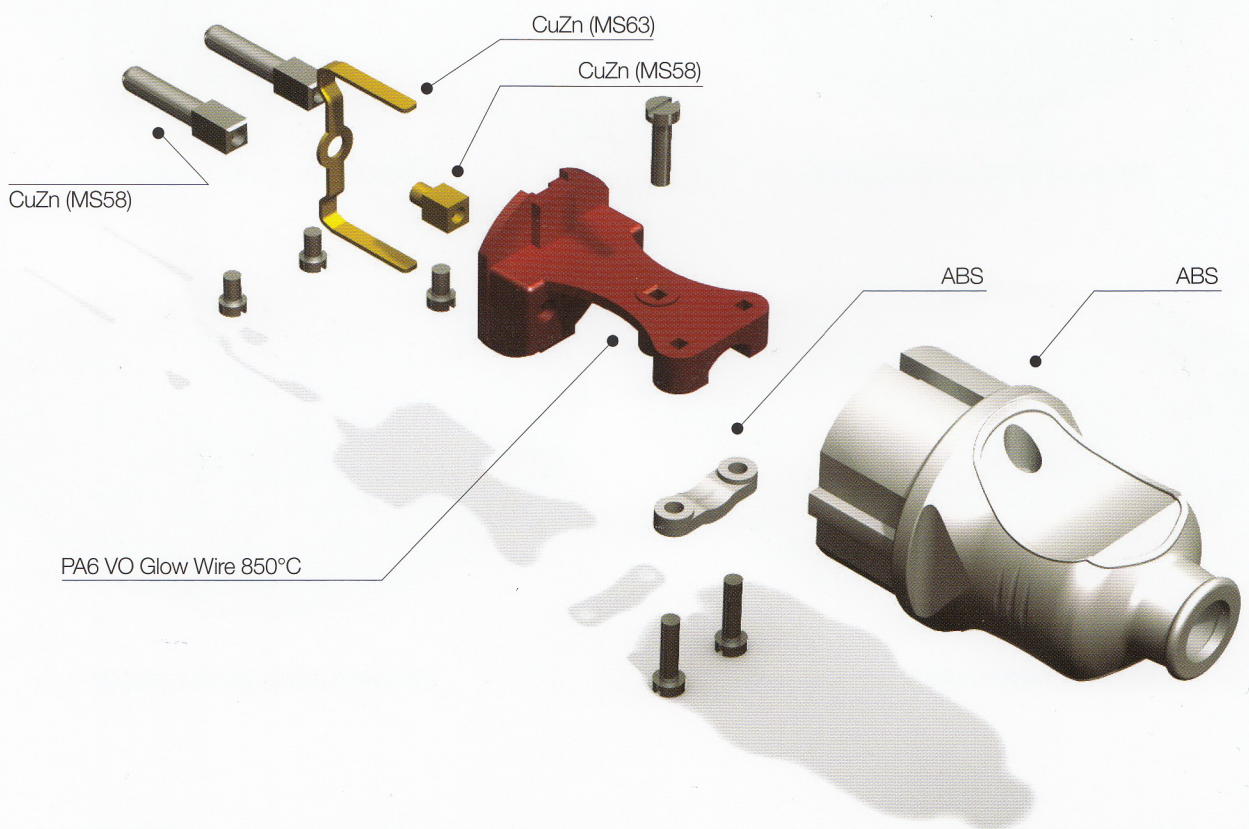

CuZn (MS58)

CuZn (MS63)

CuZn (MS58)

ABS

ABS

PA6 VO Glow Wire 850°C

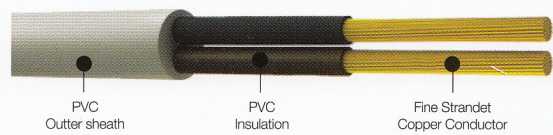

PVC Outer sheath

PVC Insulation

Fine Strandet Copper Conductor



Cross Section	Overall Diameter	Conductor mm	Conductor PCS
2 x 0.75 mm ²	6.4 mm	0.19	24
3 x 1 mm ²	7.2 mm	0.19	32
3 x 1.5 mm ²	8.5 mm	0.24	30